



[p. ??]

Cascading Style Sheets Level 2 Revision 1 (CSS 2.1) Specification

W3C Working Draft 07 December 2010

This version:

<http://www.w3.org/TR/2010/WD-CSS2-20101207> [p. ??]

Latest version:

<http://www.w3.org/TR/CSS2> [p. ??]

Previous versions:

<http://www.w3.org/TR/2009/CR-CSS2-20090908> [p. ??]

<http://www.w3.org/TR/2008/REC-CSS2-20080411/> [p. ??]

Editors:

Bert Bos [p. ??] <bert @w3.org>

Tantek Çelik [p. ??] <tantek @cs.stanford.edu>

Ian Hickson [p. ??] <ian @hixie.ch>

Håkon Wium Lie [p. ??] <howcome @opera.com>

Please refer to the **errata** [p. ??] for this document.

This document is also available in these non-normative formats: plain text [p. ??] , gzip'ed tar file [p. ??] , zip file [p. ??] , gzip'ed PostScript [p. ??] , PDF [p. ??] . See also **translations** [p. ??] .

Copyright [p. ??] © 2009 World Wide Web ConsortiumW3C [p. ??] ® (Massachusetts Institute of TechnologyMIT [p. ??] , European Research Consortium for Informatics and MathematicsERCIM [p. ??] , Keio [p. ??]), All Rights Reserved. W3C liability [p. ??] , trademark [p. ??] and document use [p. ??] rules apply.

Abstract

This specification defines Cascading Style Sheets, level 2 revision 1 (CSS 2.1). CSS 2.1 is a style sheet language that allows authors and users to attach style (e.g., fonts and spacing) to structured documents (e.g., HTML documents and XML applications). By separating the presentation style of documents from the content of documents, CSS 2.1 simplifies Web authoring and site maintenance.

CSS 2.1 builds on CSS2 [CSS2] which builds on CSS1 [CSS1]. It supports media-specific style sheets so that authors may tailor the presentation of their documents to visual browsers, aural devices, printers, braille devices, handheld devices, etc. It also supports content positioning, table layout, features for internationalization

and some properties related to user interface.

CSS 2.1 corrects a few errors in CSS2 (the most important being a new definition of the height/width of absolutely positioned elements, more influence for HTML's "style" attribute and a new calculation of the 'clip' property), and adds a few highly requested features which have already been widely implemented. But most of all CSS 2.1 represents a "snapshot" of CSS usage: it consists of all CSS features that are implemented interoperably at the date of publication of the Recommendation.

CSS 2.1 is derived from and is intended to replace CSS2. Some parts of CSS2 are unchanged in CSS 2.1, some parts have been altered, and some parts removed. The removed portions may be used in a future CSS3 specification. Future specs should refer to CSS 2.1 (unless they need features from CSS2 which have been dropped in CSS 2.1, and then they should only reference CSS2 for those features, or preferably reference such feature(s) in the respective CSS3 Module that includes those feature(s)).

Status of this document

This section describes the status of this document at the time of its publication. Other documents may supersede this document. A list of current W3C publications and the latest revision of this technical report can be found in the W3C technical reports index at <http://www.w3.org/TR/>. [p. ??]

Publication as a Working Draft does not imply endorsement by the W3C Membership. This is a draft document and may be updated, replaced or obsoleted by other documents at any time. It is inappropriate to cite this document as other than work in progress.

The (archived [p. ??]) public mailing list www-style@w3.org [p. ??] (see instructions [p. ??]) is preferred for discussion of this specification. When sending e-mail, please put the text "CSS21" in the subject, preferably like this: "[CSS21] □summary of comment□"

This document was produced by the CSS Working Group [p. ??] (part of the Style Activity [p. ??]).

This document was produced by a group operating under the 5 February 2004 W3C Patent Policy [p. ??] . W3C maintains a public list of any patent disclosures [p. ??] made in connection with the deliverables of the group; that page also includes instructions for disclosing a patent. An individual who has actual knowledge of a patent which the individual believes contains Essential Claim(s) [p. ??] must disclose the information in accordance with section 6 of the W3C Patent Policy [p. ??] .

A test suite and an implementations report will be provided before the document becomes a Proposed Recommendation.

This document incorporates errata [p. ??] resulting from implementation experience since the previous publication. Some of the corrections remove ambiguities or change the behavior in edge cases, and the Working Group therefore published this Working Draft, in order to invite more review. If that review is positive, the expected

next publication is a Proposed Recommendation.

Candidate Recommendation Exit Criteria

For this specification to enter Proposed Recommendation, the following conditions must be met:

1. There must be at least two interoperable implementations for every feature. For the purposes of this criterion, we define the following terms:

feature

A section or subsection of the specification.

interoperable

passing the respective test cases in the test suite, or, if the implementation is not a web browser, equivalent tests. Every relevant test in the test suite should have an equivalent test created if such a UA is to be used to claim interoperability. In addition if such a UA is to be used to claim interoperability, then there must one or more additional UAs which can also pass those equivalent tests in the same way for the purpose of interoperability. The equivalent tests must be made publicly available for the purposes of peer review.

implementation

a user agent which:

1. implements the feature.
 2. is available (i.e., publicly downloadable or available through some other public point of sale mechanism). This is the "show me" requirement.
 3. is shipping (i.e., development, private or unofficial versions are insufficient).
 4. is not experimental (i.e., is intended for a wide audience and could be used on a daily basis).
2. A minimum of six months of the CR period must have elapsed. This is to ensure that enough time is given for any remaining major errors to be caught.
 3. The CR period will be extended if implementations are slow to appear.
 4. Features that were not in CSS1 will be dropped (thus reducing the list of "all" features mentioned above) if two or more interoperable implementations of those features are not found by the end of the CR period.
 5. Features will also be dropped if sufficient and adequate tests (by judgment of the working group) have not been produced for those features by the end of the CR period.

Features at risk

The working group has identified the following features as being currently poorly implemented by UAs. They are therefore most at risk of being removed from CSS 2.1 when exiting CR. (Any changes of this nature will still result in the specification being returned to last call.) Implementors are urged to implement these features, or correct bugs in their implementations, if they wish to see these features remain in this specification.

New 'list-style-type' values

- 'armenian'
- 'georgian'
- 'lower-greek'

Implementors are advised to look at CSS3 Lists instead, where these and many other new values not found in CSS1 are defined in detail. [CSS3LIST]

Support for multiple ID attributes for the ID selector

Because implementations are not expected to support multiple IDs per element soon, this feature may be made informative. The W3C Selectors specification will continue to have this feature normatively. (Section 5.9. [p. 86])

Automatic table layout algorithm

The input to the suggested (non-normative) automatic layout algorithm for tables is restricted to (1) the containing block width and (2) the content and properties of the table and its children. This restriction may be lifted.

Quotes

The 'quotes' property and the 'open-quote', 'close-quote', 'no-open-quote' and 'no-close-quote' keywords may be dropped.

BODY element in XHTML

The effect of 'overflow' [p. 195] and 'background' [p. 231] is different on BODY elements in HTML than on other elements. It may be that the exceptional handling of BODY in HTML is extended to BODY in XHTML1.

Quick Table of Contents

1 About the CSS 2.1 Specification	27
2 Introduction to CSS 2.1	35
3 Conformance: Requirements and Recommendations	43
4 Syntax and basic data types	49
5 Selectors	77
6 Assigning property values, Cascading, and Inheritance	99
7 Media types	107
8 Box model	111
9 Visual formatting model	127
10 Visual formatting model details	171
11 Visual effects	195
12 Generated content, automatic numbering, and lists	203
13 Paged media	221
14 Colors and Backgrounds	231
15 Fonts	241
16 Text	257
17 Tables	269
18 User interface	297
Appendix A. Aural style sheets	305
Appendix B. Bibliography	325
Appendix C. Changes	329
Appendix D. Default style sheet for HTML 4	435
Appendix E. Elaborate description of Stacking Contexts	437
Appendix F. Full property table	441
Appendix G. Grammar of CSS 2.1	449
Appendix I. Index	457

Full Table of Contents

1	About the CSS 2.1 Specification	27
1.1	CSS 2.1 vs CSS 2	27
1.2	Reading the specification	28
1.3	How the specification is organized	28
1.4	Conventions	29
1.4.1	Document language elements and attributes	29
1.4.2	CSS property definitions	29
1.4.2.1	Value	29
1.4.2.2	Initial	31
1.4.2.3	Applies to	31
1.4.2.4	Inherited	31
1.4.2.5	Percentage values	31
1.4.2.6	Media groups	31
1.4.2.7	Computed value	32
1.4.3	Shorthand properties	32
1.4.4	Notes and examples	32
1.4.5	Images and long descriptions	33
1.5	Acknowledgments	33
2	Introduction to CSS 2.1	35
2.1	A brief CSS 2.1 tutorial for HTML	35
2.2	A brief CSS 2.1 tutorial for XML	38
2.3	The CSS 2.1 processing model	39
2.3.1	The canvas	40
2.3.2	CSS 2.1 addressing model	40
2.4	CSS design principles	41
3	Conformance: Requirements and Recommendations	43
3.1	Definitions	43
3.2	UA Conformance	47
3.3	Error conditions	48
3.4	The text/css content type	48
4	Syntax and basic data types	49
4.1	Syntax	49
4.1.1	Tokenization	50
4.1.2	Keywords	53
4.1.2.1	Vendor-specific extensions	54
4.1.2.2	Informative Historical Notes	54
4.1.3	Characters and case	55
4.1.4	Statements	56
4.1.5	At-rules	57
4.1.6	Blocks	57
4.1.7	Rule sets, declaration blocks, and selectors	58

4.1.8	Declarations and properties	59
4.1.9	Comments	60
4.2	Rules for handling parsing errors	60
4.3	Values	63
4.3.1	Integers and real numbers	63
4.3.2	Lengths	63
4.3.3	Percentages	66
4.3.4	URLs and URIs	67
4.3.5	Counters	68
4.3.6	Colors	68
4.3.7	Strings	70
4.3.8	Unsupported Values	70
4.4	CSS style sheet representation	71
4.4.1	Referring to characters not represented in a character encoding	74
5	Selectors	77
5.1	Pattern matching	77
5.2	Selector syntax	79
5.2.1	Grouping	79
5.3	Universal selector	80
5.4	Type selectors	80
5.5	Descendant selectors	80
5.6	Child selectors	81
5.7	Adjacent sibling selectors	81
5.8	Attribute selectors	82
5.8.1	Matching attributes and attribute values	82
5.8.2	Default attribute values in DTDs	84
5.8.3	Class selectors	85
5.9	ID selectors	86
5.10	Pseudo-elements and pseudo-classes	87
5.11	Pseudo-classes	88
5.11.1	:first-child pseudo-class	88
5.11.2	The link pseudo-classes: :link and :visited	89
5.11.3	The dynamic pseudo-classes: :hover, :active, and :focus	89
5.11.4	The language pseudo-class: :lang	91
5.12	Pseudo-elements	92
5.12.1	The :first-line pseudo-element	92
5.12.2	The :first-letter pseudo-element	94
5.12.3	The :before and :after pseudo-elements	97
6	Assigning property values, Cascading, and Inheritance	99
6.1	Specified, computed, and actual values	99
6.1.1	Specified values	99
6.1.2	Computed values	100
6.1.3	Used values	100

6.1.4 Actual values	100
6.2 Inheritance	100
6.2.1 The 'inherit' value	101
6.3 The @import rule	102
6.4 The cascade	103
6.4.1 Cascading order	103
6.4.2 Important rules	104
6.4.3 Calculating a selector's specificity	105
6.4.4 Precedence of non-CSS presentational hints	105
7 Media types	107
7.1 Introduction to media types	107
7.2 Specifying media-dependent style sheets	107
7.2.1 The @media rule	108
7.3 Recognized media types	108
7.3.1 Media groups	110
8 Box model	111
8.1 Box dimensions	111
8.2 Example of margins, padding, and borders	113
8.3 Margin properties: 'margin-top', 'margin-right', 'margin-bottom', 'margin-left', and 'margin'	115
8.3.1 Collapsing margins	117
8.4 Padding properties: 'padding-top', 'padding-right', 'padding-bottom', 'padding-left', and 'padding'	118
8.5 Border properties	120
8.5.1 Border width: 'border-top-width', 'border-right-width', 'border-bottom-width', 'border-left-width', and 'border-width'	120
8.5.2 Border color: 'border-top-color', 'border-right-color', 'border-bottom-color', 'border-left-color', and 'border-color'	121
8.5.3 Border style: 'border-top-style', 'border-right-style', 'border-bottom-style', 'border-left-style', and 'border-style'	122
8.5.4 Border shorthand properties: 'border-top', 'border-right', 'border-bottom', 'border-left', and 'border'	124
8.6 The box model for inline elements in bidirectional context	126
9 Visual formatting model	127
9.1 Introduction to the visual formatting model	127
9.1.1 The viewport	128
9.1.2 Containing blocks	128
9.2 Controlling box generation	129
9.2.1 Block-level elements and block boxes	129
9.2.1.1 Anonymous block boxes	129
9.2.2 Inline-level elements and inline boxes	131
9.2.2.1 Anonymous inline boxes	132
9.2.3 Run-in boxes	132
9.2.4 The 'display' property	133

9.3	Positioning schemes	135
9.3.1	Choosing a positioning scheme: 'position' property	135
9.3.2	Box offsets: 'top', 'right', 'bottom', 'left'	136
9.4	Normal flow	138
9.4.1	Block formatting contexts	139
9.4.2	Inline formatting contexts	139
9.4.3	Relative positioning	142
9.5	Floats	143
9.5.1	Positioning the float: the 'float' property	147
9.5.2	Controlling flow next to floats: the 'clear' property	149
9.6	Absolute positioning	152
9.6.1	Fixed positioning	152
9.7	Relationships between 'display', 'position', and 'float'	154
9.8	Comparison of normal flow, floats, and absolute positioning	155
9.8.1	Normal flow	155
9.8.2	Relative positioning	156
9.8.3	Floating a box	157
9.8.4	Absolute positioning	160
9.9	Layered presentation	164
9.9.1	Specifying the stack level: the 'z-index' property	164
9.10	Text direction: the 'direction' and 'unicode-bidi' properties	166
10	Visual formatting model details	171
10.1	Definition of "containing block"	171
10.2	Content width: the 'width' property	174
10.3	Calculating widths and margins	175
10.3.1	Inline, non-replaced elements	175
10.3.2	Inline, replaced elements	176
10.3.3	Block-level, non-replaced elements in normal flow	176
10.3.4	Block-level, replaced elements in normal flow	177
10.3.5	Floating, non-replaced elements	177
10.3.6	Floating, replaced elements	177
10.3.7	Absolutely positioned, non-replaced elements	177
10.3.8	Absolutely positioned, replaced elements	179
10.3.9	'Inline-block', non-replaced elements in normal flow	179
10.3.10	'Inline-block', replaced elements in normal flow	180
10.4	Minimum and maximum widths: 'min-width' and 'max-width'	180
10.5	Content height: the 'height' property	182
10.6	Calculating heights and margins	184
10.6.1	Inline, non-replaced elements	184
10.6.2	Inline replaced elements, block-level replaced elements in normal flow, 'inline-block' replaced elements in normal flow and floating replaced elements	185
10.6.3	Block-level non-replaced elements in normal flow when 'over-	

flow' computes to 'visible'	185
10.6.4 Absolutely positioned, non-replaced elements	186
10.6.5 Absolutely positioned, replaced elements	187
10.6.6 Complicated cases	187
10.6.7 'Auto' heights for block formatting context roots	188
10.7 Minimum and maximum heights: 'min-height' and 'max-height'	188
10.8 Line height calculations: the 'line-height' and 'vertical-align' properties	190
10.8.1 Leading and half-leading	190
11 Visual effects	195
11.1 Overflow and clipping	195
11.1.1 Overflow: the 'overflow' property	195
11.1.2 Clipping: the 'clip' property	198
11.2 Visibility: the 'visibility' property	201
12 Generated content, automatic numbering, and lists	203
12.1 The :before and :after pseudo-elements	203
12.2 The 'content' property	205
12.3 Quotation marks	207
12.3.1 Specifying quotes with the 'quotes' property	207
12.3.2 Inserting quotes with the 'content' property	209
12.4 Automatic counters and numbering	210
12.4.1 Nested counters and scope	212
12.4.2 Counter styles	214
12.4.3 Counters in elements with 'display: none'	214
12.5 Lists	214
12.5.1 Lists: the 'list-style-type', 'list-style-image', 'list-style-position', and 'list-style' properties	215
13 Paged media	221
13.1 Introduction to paged media	221
13.2 Page boxes: the @page rule	222
13.2.1 Page margins	222
13.2.2 Page selectors: selecting left, right, and first pages	224
13.2.3 Content outside the page box	225
13.3 Page breaks	225
13.3.1 Page break properties: 'page-break-before', 'page-break-after', 'page-break-inside'	225
13.3.2 Breaks inside elements: 'orphans', 'widows'	227
13.3.3 Allowed page breaks	227
13.3.4 Forced page breaks	228
13.3.5 "Best" page breaks	228
13.4 Cascading in the page context	229
14 Colors and Backgrounds	231
14.1 Foreground color: the 'color' property	231
14.2 The background	231

14.2.1 Background properties: 'background-color', 'background-image', 'background-repeat', 'background-attachment', 'background-position', and 'background'	232
14.3 Gamma correction	238
15 Fonts	241
15.1 Introduction	241
15.2 Font matching algorithm	241
15.3 Font family: the 'font-family' property	242
15.3.1 Generic font families	244
15.3.1.1 <i>serif</i>	244
15.3.1.2 <i>sans-serif</i>	245
15.3.1.3 <i>cursive</i>	246
15.3.1.4 <i>fantasy</i>	246
15.3.1.5 <i>monospace</i>	246
15.4 Font styling: the 'font-style' property	247
15.5 Small-caps: the 'font-variant' property	247
15.6 Font boldness: the 'font-weight' property	248
15.7 Font size: the 'font-size' property	251
15.8 Shorthand font property: the 'font' property	253
16 Text	257
16.1 Indentation: the 'text-indent' property	257
16.2 Alignment: the 'text-align' property	258
16.3 Decoration	259
16.3.1 Underlining, overlining, striking, and blinking: the 'text-decoration' property	259
16.4 Letter and word spacing: the 'letter-spacing' and 'word-spacing' properties	262
16.5 Capitalization: the 'text-transform' property	263
16.6 White space: the 'white-space' property	264
16.6.1 The 'white-space' processing model	265
16.6.2 Example of bidirectionality with white space collapsing	266
16.6.3 Control and combining characters' details	267
17 Tables	269
17.1 Introduction to tables	269
17.2 The CSS table model	271
17.2.1 Anonymous table objects	273
17.3 Columns	275
17.4 Tables in the visual formatting model	276
17.4.1 Caption position and alignment	277
17.5 Visual layout of table contents	278
17.5.1 Table layers and transparency	279
17.5.2 Table width algorithms: the 'table-layout' property	282
17.5.2.1 Fixed table layout	283
17.5.2.2 Automatic table layout	284

17.5.3 Table height algorithms	285
17.5.4 Horizontal alignment in a column	287
17.5.5 Dynamic row and column effects	287
17.6 Borders	288
17.6.1 The separated borders model	288
17.6.1.1 Borders and Backgrounds around empty cells: the 'empty-cells' property	290
17.6.2 The collapsing border model	291
17.6.2.1 Border conflict resolution	292
17.6.3 Border styles	294
18 User interface	297
18.1 Cursors: the 'cursor' property	297
18.2 System Colors	298
18.3 User preferences for fonts	300
18.4 Dynamic outlines: the 'outline' property	300
18.4.1 Outlines and the focus	302
18.5 Magnification	303
Appendix A. Aural style sheets	305
A.1 The media types 'aural' and 'speech'	305
A.2 Introduction to aural style sheets	306
A.2.1 Angles	307
A.2.2 Times	307
A.2.3 Frequencies	307
A.3 Volume properties: 'volume'	308
A.4 Speaking properties: 'speak'	309
A.5 Pause properties: 'pause-before', 'pause-after', and 'pause'	310
A.6 Cue properties: 'cue-before', 'cue-after', and 'cue'	311
A.7 Mixing properties: 'play-during'	312
A.8 Spatial properties: 'azimuth' and 'elevation'	313
A.9 Voice characteristic properties: 'speech-rate', 'voice-family', 'pitch', 'pitch-range', 'stress', and 'richness'	316
A.10 Speech properties: 'speak-punctuation' and 'speak-numeral'	319
A.11 Audio rendering of tables	320
A.11.1 Speaking headers: the 'speak-header' property	321
A.12 Sample style sheet for HTML	323
A.13 Emacspeak	324
Appendix B. Bibliography	325
B.1 Normative references	325
B.2 Informative references	327
Appendix C. Changes	329
C.1 Additional property values	341
C.1.1 Section 4.3.6 Colors	341
C.1.2 Section 9.2.4 The 'display' property	341

C.1.3 Section 12.2 The 'content' property	341
C.1.4 Section 16.6 White space: the 'white-space' property	341
C.1.5 Section 18.1 Cursors: the 'cursor' property	341
C.2 Changes	342
C.2.1 Section 1.1 CSS 2.1 vs CSS 2	342
C.2.2 Section 1.2 Reading the specification	342
C.2.3 Section 1.3 How the specification is organized	342
C.2.4 Section 1.4.2.1 Value	342
C.2.5 Section 1.4.2.6 Media groups	342
C.2.6 Section 1.4.2.7 Computed value	342
C.2.7 Section 1.4.4 Notes and examples	342
C.2.8 Section 1.5 Acknowledgments	342
C.2.9 Section 3.2 Conformance	343
C.2.10 Section 3.3 Error Conditions	343
C.2.11 Section 4.1.1 Tokenization	343
C.2.12 Section 4.1.3 Characters and case	343
C.2.13 Section 4.2 Rules for handling parsing errors	344
C.2.14 Section 4.3 Values	344
C.2.15 Section 4.3.2 Lengths	344
C.2.16 Section 4.3.4 URLs and URIs	344
C.2.17 Section 4.3.5 Counters	344
C.2.18 Section 4.3.6 Colors	344
C.2.19 Section 4.3.8 Unsupported Values	344
C.2.20 Section 4.4 CSS style sheet representation	344
C.2.21 Section 5.8.1 Matching attributes and attribute values	345
C.2.22 Section 5.8.3 Class selectors	345
C.2.23 Section 5.9 ID selectors	345
C.2.24 Section 5.10 Pseudo-elements and pseudo-classes	345
C.2.25 Section 5.11.2 The link pseudo-classes: :link and :visited	345
C.2.26 Section 5.11.4 The language pseudo-class: :lang	345
C.2.27 Section 5.12.1 The :first-line pseudo-element	346
C.2.28 Section 5.12.2 The :first-letter pseudo-element	346
C.2.29 Section 6.1 Specified, computed, and actual values	346
C.2.30 Section 6.4.1 Cascading order	346
C.2.31 Section 6.4.3 Calculating a selector's specificity	347
C.2.32 Section 6.4.4 Precedence of non-CSS presentational hints	347
C.2.33 Section 7.3 Recognized Media Types	347
C.2.34 Section 7.3.1 Media Groups	347
C.2.35 Section 8.3 Margin properties	347
C.2.36 Section 8.3.1 Collapsing margins	347
C.2.37 Section 8.4 Padding properties	348
C.2.38 Section 8.5.2 Border color	348
C.2.39 Section 8.5.3 Border style	348

C.2.40 Section 8.6 The box model for inline elements in bidirectional context 348

C.2.41 Section 9.1.2 Containing blocks 348

C.2.42 Section 9.2.1.1 Anonymous block boxes 348

C.2.43 Section 9.2.2.1 Anonymous inline boxes 348

C.2.44 Section 9.2.3 Run-in boxes 348

C.2.45 Section 9.2.4 The 'display' property 348

C.2.46 Section 9.3.1 Choosing a positioning scheme 349

C.2.47 Section 9.3.2 Box offsets 349

C.2.48 Section 9.4.1 Block formatting contexts 349

C.2.49 Section 9.4.2 Inline formatting context 349

C.2.50 Section 9.4.3 Relative positioning 350

C.2.51 Section 9.5 Floats 350

C.2.52 Section 9.5.1 Positioning the float 350

C.2.53 Section 9.5.2 Controlling flow next to floats 350

C.2.54 Section 9.7 Relationships between 'display', 'position', and 'float' 350

C.2.55 Section 9.9 Layered presentation 351

C.2.56 Section 9.10 Text direction 351

C.2.57 Chapter 10 Visual formatting model details 351

C.2.58 Section 10.1 Definition of "containing block" 351

C.2.59 Section 10.2 Content width 352

C.2.60 Section 10.3 Calculating widths and margins 352

C.2.61 Section 10.3.2 Inline, replaced elements 352

C.2.62 Section 10.3.3 Block-level, non-replaced elements in normal flow 352

C.2.63 Section 10.3.4 Block-level, replaced elements in normal flow 352

C.2.64 Section 10.3.5 Floating, non-replaced elements 352

C.2.65 Section 10.3.6 Floating, replaced elements 352

C.2.66 Section 10.3.7 Absolutely positioned, non-replaced elements 353

C.2.67 Section 10.3.8 Absolutely positioned, replaced elements . 353

C.2.68 Section 10.4 Minimum and maximum widths 353

C.2.69 Section 10.5 Content height 353

C.2.70 Section 10.6 Calculating heights and margins 354

C.2.71 Section 10.6.1 Inline, non-replaced elements 354

C.2.72 Section 10.6.2 Inline replaced elements, block-level replaced elements in normal flow, 'inline-block' replaced elements in normal flow and floating replaced elements 354

C.2.73 Section 10.6.3 Block-level non-replaced elements in normal flow when 'overflow' computes to 'visible' 354

C.2.74 Section 10.6.4 Absolutely positioned, non-replaced elements 354

C.2.75 Section 10.6.5 Absolutely positioned, replaced elements . 355

C.2.76 Section 10.7 Minimum and maximum heights 355

C.2.77 Section 10.8 Line height calculations 355

C.2.78 Section 10.8.1 Leading and half-leading 355

C.2.79 Section 11.1 Overflow and clipping 355

C.2.80 Section 11.1.1 Overflow 355

C.2.81 Section 11.1.2 Clipping: the 'clip' property 356

C.2.82 Section 11.2 Visibility 356

C.2.83 Chapter 12 Generated content, automatic numbering, and lists 356

C.2.84 Section 12.1 The :before and :after pseudo-elements . . . 356

C.2.85 Section 12.2 The 'content' property 356

C.2.86 Section 12.3.2 Inserting quotes with the 'content' property 357

C.2.87 Section 12.4 Automatic counters and numbering 357

C.2.88 Section 12.4.1 Nested counters and scope 357

C.2.89 Section 12.5 Lists 357

C.2.90 Section 12.5.1 Lists 357

C.2.91 Chapter 13 Paged media 358

C.2.92 Section 13.2.2 Page selectors 358

C.2.93 Section 13.3.1 Page break properties 358

C.2.94 Section 13.3.3 Allowed page breaks 358

C.2.95 Section 14.2.1 Background properties 358

C.2.96 Section 14.3 Gamma correction 358

C.2.97 Chapter 15 Fonts 359

C.2.98 Section 15.2 Font matching algorithm 359

C.2.99 Section 15.2.2 Font family 359

C.2.100 Section 15.5 Small-caps 359

C.2.101 Section 15.6 Font boldness 359

C.2.102 Section 15.7 Font size 359

C.2.103 Chapter 16 Text 359

C.2.104 Section 16.2 Alignment 360

C.2.105 Section 16.3.1 Underlining, over lining, striking, and blinking 360

C.2.106 Section 16.4 Letter and word spacing 360

C.2.107 Section 16.5 Capitalization 360

C.2.108 Section 16.6 White space 360

C.2.109 Chapter 17 Tables 361

C.2.110 Section 17.2 The CSS table model 361

C.2.111 Section 17.2.1 Anonymous table objects 361

C.2.112 Section 17.4 Tables in the visual formatting model . . . 361

C.2.113 Section 17.4.1 Caption position and alignment 362

C.2.114 Section 17.5 Visual layout of table contents 362

C.2.115 Section 17.5.1 Table layers and transparency 362

C.2.116 Section 17.5.2.1 Fixed table layout 362

C.2.117 Section 17.5.2.2 Automatic table layout 362

C.2.118 Section 17.5.3 Table height algorithms 362

C.2.119 Section 17.5.4 Horizontal alignment in a column 362

C.2.120 Section 17.6 Borders 363

C.2.121	Section 17.6.1	The separated borders model	363
C.2.122	Section 17.6.1.1	Borders and Backgrounds around empty cells	363
C.2.123	Section 17.6.2	The collapsing border model	363
C.2.124	Section 17.6.2.1	Border conflict resolution	363
C.2.125	Section 18.1	Cursors: the 'cursor' property	363
C.2.126	Section 18.4	Dynamic outlines	363
C.2.127	Chapter 12	Generated content, automatic numbering, and lists	364
C.2.128	Appendix A	Aural style sheets	364
C.2.129	Appendix A Section 5	Pause properties	364
C.2.130	Appendix A Section 6	Cue properties	364
C.2.131	Appendix A Section 7	Mixing properties	364
C.2.132	Appendix B	Bibliography	364
C.2.133	Other		365
C.3	Errors		365
C.3.1	Shorthand properties		365
C.3.2	Applies to		365
C.3.3	Section 4.1.1 (and G2)		365
C.3.4	Section 4.1.3	Characters and case	366
C.3.5	Section 4.3 (Double sign problem)		366
C.3.6	Section 4.3.2	Lengths	366
C.3.7	Section 4.3.3	Percentages	366
C.3.8	Section 4.3.4	URLs and URIs	366
C.3.9	Section 4.3.5	Counters	366
C.3.10	Section 4.3.6	Colors	366
C.3.11	Section 4.3.7	Strings	367
C.3.12	Section 5.10	Pseudo-elements and pseudo-classes	367
C.3.13	Section 6.4	The cascade	367
C.3.14	Section 8.1	Box Dimensions	367
C.3.15	Section 8.2	Example of margins, padding, and borders	367
C.3.16	Section 8.5.4	Border shorthand properties	367
C.3.17	Section 9.2.1	Block-level elements and block boxes	367
C.3.18	Section 9.3.1	Choosing a positioning scheme	367
C.3.19	Section 9.3.2	Box offsets	368
C.3.20	Section 9.4.1	Block formatting contexts	368
C.3.21	Section 9.4.2	Inline formatting context	368
C.3.22	Section 9.4.3	Relative positioning	368
C.3.23	Section 9.5	Floats	368
C.3.24	Section 9.5.1	Positioning the float	368
C.3.25	Section 9.5.2	Controlling flow next to floats	368
C.3.26	Section 9.6	Absolute positioning	369
C.3.27	Section 9.7	Relationships between 'display', 'position', and 'float'	369
C.3.28	Section 9.10	Text direction	369

C.3.29	Section 10.1	Definition of "containing block"	369
C.3.30	Section 10.3.3	Block-level, non-replaced elements in normal flow	369
C.3.31	Section 10.4	Minimum and maximum widths	369
C.3.32	Section 10.6.3	Block-level non-replaced elements in normal flow when 'overflow' computes to 'visible'	369
C.3.33	Section 10.7	Minimum and maximum heights	370
C.3.34	Section 11.1.1	Overflow	370
C.3.35	Section 11.1.2	Clipping: the 'clip' property	370
C.3.36	Section 11.2	Visibility	370
C.3.37	Section 12.4.2	Counter styles	370
C.3.38	Section 12.6.2	Lists	370
C.3.39	Section 14.2	The background	371
C.3.40	Section 14.2.1	Background properties	371
C.3.41	Section 15.2	Font matching algorithm	371
C.3.42	Section 15.7	Font size	371
C.3.43	Section 16.1	Indentation	371
C.3.44	Section 16.2	Alignment	371
C.3.45	Section 17.2	The CSS table model	372
C.3.46	Section 17.2.1	Anonymous table objects	372
C.3.47	Section 17.4	Tables in the visual formatting model	372
C.3.48	Section 17.5	Visual layout of table contents	372
C.3.49	Section 17.5.1	Table layers and transparency	373
C.3.50	Section 17.6.1	The separated borders model	373
C.3.51	Section 18.2	System Colors	373
C.3.52	Section E.2	Painting order	373
C.4		Clarifications	373
C.4.1	Section 2.1	A brief CSS 2.1 tutorial for HTML	373
C.4.2	Section 2.2	A brief CSS 2.1 tutorial for XML	373
C.4.3	Section 2.3	The CSS 2.1 processing model	374
C.4.4	Section 3.1	Definitions	374
C.4.5	Section 4.1	Syntax	374
C.4.6	Section 4.1.1	Tokenization	374
C.4.7	Section 4.1.3	Characters and case	374
C.4.8	Section 4.1.7	Rule sets, declaration blocks, and selectors	375
C.4.9	Section 4.2	Rules for handling parsing errors	375
C.4.10	Section 4.3.1	Integers and real numbers	375
C.4.11	Section 4.3.2	Lengths	375
C.4.12	Section 4.3.4	URLs and URIs	375
C.4.13	Section 5.1	Pattern matching	375
C.4.14	Section 5.7	Adjacent sibling selectors	375
C.4.15	Section 5.8.1	Matching attributes and attribute values	375
C.4.16	Section 5.8.2	Default attribute values in DTDs	375

C.4.17	Section 5.9 ID selectors	376
C.4.18	Section 5.11.3 The dynamic pseudo-classes: :hover, :active, and :focus	376
C.4.19	Section 5.11.4 The language pseudo-class: :lang	376
C.4.20	Section 5.12.2 The :first-letter pseudo-element	376
C.4.21	Section 6.2 Inheritance	376
C.4.22	Section 6.2.1 The 'inherit' value	376
C.4.23	Section 6.3 The @import rule	376
C.4.24	Section 6.4 The Cascade	376
C.4.25	Section 6.4.1 Cascading order	376
C.4.26	Section 6.4.3 Calculating a selector's specificity	377
C.4.27	Section 7.2.1 The @media rule	377
C.4.28	Section 7.3 Recognized media types	377
C.4.29	Section 7.3.1 Media groups	377
C.4.30	Section 8.1 Box dimensions	377
C.4.31	Section 8.3 Margin properties	377
C.4.32	Section 8.3.1 Collapsing margins	377
C.4.33	Section 8.5.3 Border style	378
C.4.34	Section 9.1.1 The viewport	378
C.4.35	Section 9.2.4 The 'display' property	378
C.4.36	Section 9.3.1 Choosing a positioning scheme	378
C.4.37	Section 9.3.2 Box offsets	378
C.4.38	Section 9.4.2 Inline formatting context	378
C.4.39	Section 9.4.3 Relative positioning	379
C.4.40	Section 9.5 Floats	379
C.4.41	Section 9.5.1 Positioning the float	379
C.4.42	Section 9.5.2 Controlling flow next to floats	379
C.4.43	Section 9.8 Comparison of normal flow, floats, and absolute positioning	379
C.4.44	Section 10.1 Definition of "containing block"	379
C.4.45	Section 10.2 Content width	380
C.4.46	Section 10.3.3 Block-level, non-replaced elements in normal flow	380
C.4.47	Section 10.3.8 Absolutely positioning, replaced elements	380
C.4.48	Section 10.4 Minimum and maximum widths	380
C.4.49	Section 10.6 Calculating heights and margins	380
C.4.50	Section 10.7 Minimum and maximum heights	380
C.4.51	Section 10.8 Line height calculations	380
C.4.52	Section 10.8.1 Leading and half-leading	380
C.4.53	Section 11.1 Overflow and clipping	380
C.4.54	Section 11.1.1 Overflow	381
C.4.55	Section 11.1.2 Clipping	381
C.4.56	Section 11.2 Visibility	381

C.4.57	Section 12.1	The :before and :after pseudo-elements	381
C.4.58	Section 12.2	The 'content' property	381
C.4.59	Section 12.3.2	Inserting quotes with the 'content' property	381
C.4.60	Section 12.4	Automatic counters and numbering	382
C.4.61	Section 12.4.3	Counters in elements with 'display: none'	382
C.4.62	Section 14.2	The background	382
C.4.63	Section 15.1	Fonts Introduction	382
C.4.64	Section 15.2	Font matching algorithm	383
C.4.65	Section 15.2.2	Font family	383
C.4.66	Section 15.3.1	Generic font families	383
C.4.67	Section 15.4	Font styling	383
C.4.68	Section 15.5	Small-caps	383
C.4.69	Section 15.6	Font boldness	383
C.4.70	Section 15.7	Font size	383
C.4.71	Section 16.1	Indentation	384
C.4.72	Section 16.2	Alignment	384
C.4.73	Section 16.3.1	Underlining, over lining, striking, and blinking	384
C.4.74	Section 16.5	Capitalization	384
C.4.75	Section 16.6	White space	384
C.4.76	Section 17.1	Introduction to tables	384
C.4.77	Section 17.2	The CSS table model	384
C.4.78	Section 17.2.1	Anonymous table objects	384
C.4.79	Section 17.4	Tables in the visual formatting model	385
C.4.80	Section 17.5	Visual layout of table contents	385
C.4.81	Section 17.5.1	Table layers and transparency	385
C.4.82	Section 17.5.2	Table width algorithms	385
C.4.83	Section 17.5.2.1	Fixed table layout	385
C.4.84	Section 17.5.2.2	Automatic table layout	386
C.4.85	Section 17.5.4	Horizontal alignment in a column	386
C.4.86	Section 17.5.5	Dynamic row and column effects	386
C.4.87	Section 17.6.1	The separated borders model	386
C.4.88	Section 17.6.2	The collapsing borders model	386
C.4.89	Section 18.2	System Colors	386
C.4.90	Section 18.4	Dynamic outlines	386
C.4.91	Section 18.4.1	Outlines and the focus	387
C.4.92	Appendix D	Default style sheet for HTML 4	387
C.5	Errata since the Candidate Recommendation of July 2007		387
C.5.1	Section 1.4.2.1	Value	387
C.5.2	Section 2.3	The CSS 2.1 processing model	387
C.5.3	Section 3.1	Definitions	387
C.5.4	Section 4.1.1	Tokenization	387
C.5.5	Section 4.1.2.2	Informative Historical Notes	388
C.5.6	Section 4.1.3	Characters and case	388

C.5.7 Section 4.1.3 Characters and case 388

C.5.8 Section 4.1.3 Characters and case 388

C.5.9 Section 4.1.3 Characters and case 388

C.5.10 Section 4.1.5 At-rules 388

C.5.11 Section 4.1.7 Rule sets, declaration blocks, and selectors 389

C.5.12 Section 4.2 Rules for handling parsing errors 389

C.5.13 Section 4.2 Rules for handling parsing errors 389

C.5.14 Section 4.3.2 Lengths 389

C.5.15 Section 4.3.5 Counters 389

C.5.16 Section 5.8.1 Matching attributes and attribute values . 390

C.5.17 Section 5.8.2 Default attribute values in DTDs 390

C.5.18 Section 5.11.4 The language pseudo-class: :lang 390

C.5.19 Section 5.12.3 The :before and :after pseudo-elements . 390

C.5.20 Section 6.3 The @import rule 390

C.5.21 Section 6.3 The @import rule 390

C.5.22 Section 6.4.1 Cascading order 391

C.5.23 Section 6.4.1 Cascading order 391

C.5.24 Section 7.2.1 The @media rule 391

C.5.25 Section 8.3.1 Collapsing margins 391

C.5.26 Section 8.3.1 Collapsing margins 391

C.5.27 Section 8.3.1 Collapsing margins 391

C.5.28 Section 9.2.2 Inline-level elements and inline boxes . . 392

C.5.29 Section 9.2.4 The 'display' property 392

C.5.30 Section 9.3.2 Box offsets: 'top', 'right', 'bottom', 'left' . . 392

C.5.31 Section 9.5 Floats 392

C.5.32 Section 9.5 Floats 392

C.5.33 Section 9.5.2 Controlling flow next to floats: the 'clear' property 392

C.5.34 Section 9.6.1 Fixed positioning 393

C.5.35 Section 9.9.1 Specifying the stack level: the 'z-index' property 393

C.5.36 Section 10.1 Definition of "containing block" 393

C.5.37 Section 10.3 Calculating widths and margins 393

C.5.38 Section 10.3.1 Inline, non-replaced elements 394

C.5.39 Section 10.3.2 Inline, replaced elements 394

C.5.40 Section 10.3.2 Inline, replaced elements 394

C.5.41 Section 10.3.3 Block-level, non-replaced elements in normal flow 394

C.5.42 Section 10.3.7 Absolutely positioned, non-replaced elements 395

C.5.43 Section 10.3.7 Absolutely positioned, non-replaced elements 395

C.5.44 Section 10.3.8 Absolutely positioned, replaced elements . 395

C.5.45 Section 10.3.8 Absolutely positioned, replaced elements . 395

C.5.46 Section 10.3.8 Absolutely positioned, replaced elements . 396

C.5.47 Section 10.5 Content height: the 'height' property . . . 396

C.5.48 Section 10.6.2 Inline replaced elements [□] 396

C.5.49 Section 10.6.4 Absolutely positioned, non-replaced elements 396

C.5.50 Section 10.6.5 Absolutely positioned, replaced elements . 396

C.5.51 Section 10.8.1 Leading and half-leading 396

C.5.52 Section 11.1.1 Overflow: the 'overflow' property 397

C.5.53 Section 11.1.2 Clipping: the 'clip' property 397

C.5.54 Section 12.2 The 'content' property 397

C.5.55 Section 12.4.2 Counter styles 397

C.5.56 Section 12.5 Lists 397

C.5.57 Section 12.5.1 Lists: the 'list-style-type', 'list-style-image',
'list-style-position', and 'list-style' properties 398

C.5.58 Section 12.5.1 Lists: the 'list-style-type', 'list-style-image',
'list-style-position', and 'list-style' properties 398

C.5.59 Section 12.5.1 Lists: the 'list-style-type', 'list-style-image',
'list-style-position', and 'list-style' properties 398

C.5.60 Section 13.2 Page boxes: the @page rule 398

C.5.61 Section 13.2.1.1 Rendering page boxes that do not fit a target
sheet 399

C.5.62 Section 13.2.3 Content outside the page box 399

C.5.63 Section 13.3.1 Page break properties: 'page-break-before',
'page-break-after', 'page-break-inside' 399

C.5.64 Section 13.3.1 Page break properties: 'page-break-before',
'page-break-after', 'page-break-inside' 399

C.5.65 Section 13.3.2 Breaks inside elements: 'orphans', 'widows' 399

C.5.66 Section 13.3.2 Breaks inside elements: 'orphans', 'widows' 399

C.5.67 Section 13.3.3 Allowed page breaks 399

C.5.68 Section 13.3.3 Allowed page breaks 400

C.5.69 Section 13.3.3 Allowed page breaks 400

C.5.70 Section 13.3.5 "Best" page breaks 400

C.5.71 Section 14.2 The background 400

C.5.72 Section 14.2 The background 400

C.5.73 Section 14.2.1 Background properties: 'background-color',
'background-image', 'background-repeat', 'background-attachment',
'background-position', and 'background' 401

C.5.74 Section 15.6 Font boldness: the 'font-weight' property . 401

C.5.75 Section 16.6 Whitespace: the 'white-space' property . . 401

C.5.76 Section 16.6.1 The 'white-space' processing model . . 402

C.5.77 Section 17.2.1 Anonymous table objects 402

C.5.78 Section 17.2.1 Anonymous table objects 402

C.5.79 Section 17.4 Tables in the visual formatting model . . 402

C.5.80 Section 17.5.4 Horizontal alignment in a column . . . 402

C.5.81 Section 18.1 Cursors: the 'cursor' property 403

C.5.82 Section B.2 Informative references 403

C.5.83 Appendix D. Default style sheet for HTML 4 403

C.5.84 Appendix D. Default style sheet for HTML 4 403

C.5.85	Section E.2	Painting order	403
C.5.86	Appendix G.	Grammar of CSS 2.1	403
C.5.87	Section G.1	Grammar	404
C.5.88	Section G.2	Lexical scanner	404
C.5.89	Section G.2	Lexical scanner	404
C.5.90	Section G.2	Lexical scanner	404
C.5.91	Section G.2	Lexical scanner	404
C.5.92	Appendix I.	Index	404
C.6	Errata since the Candidate Recommendation of April 2009		405
C.6.1	Section 4.2	Rules for handling parsing errors	405
C.6.2	Section 13.3.3	Allowed page breaks	405
C.6.3	Section 15.3	Font family: the 'font-family' property	405
C.6.4	Section 15.3.1.1	serif	405
C.6.5	Section 15.7	Font size: the 'font-size' property	405
C.6.6	Section 17.5.2.1	Fixed table layout	406
C.6.7	Section 17.5.3	Table height layout	406
C.6.8	Appendix G.	Grammar of CSS 2.1	406
C.7	Errata since the Candidate Recommendation of September 2009		406
C.7.1	Section 1.4.2.1	Value	406
C.7.2	Section 3.1	Definitions	406
C.7.3	Section 4.1.1	Tokenization	407
C.7.4	Section 4.1.1	Tokenization	407
C.7.5	Section 4.1.1	Tokenization	407
C.7.6	Section 4.1.1	Tokenization	407
C.7.7	Section 4.1.2.2	Informative Historical Notes	408
C.7.8	Section 4.1.3	Characters and case	408
C.7.9	Section 4.1.3	Characters and case	408
C.7.10	Section 4.1.8	Declarations and properties	408
C.7.11	Section 4.2	Rules for handling parsing errors	408
C.7.12	Section 4.3.2	Lengths	408
C.7.13	Section 4.3.2	Lengths	408
C.7.14	Section 4.3.4	URLs and URIs	409
C.7.15	Section 4.3.4	URLs and URIs	409
C.7.16	Section 5.8.2	Default attribute values in DTDs	409
C.7.17	Section 5.11.4	The language pseudo-class: :lang	409
C.7.18	Section 5.12	Pseudo-elements	409
C.7.19	Section 5.12.1	The :first-line pseudo-element	410
C.7.20	Section 5.12.2	The :first-letter pseudo-element	410
C.7.21	Section 6.2	Inheritance	410
C.7.22	Section 6.4.4	Precedence of non-CSS presentational hints	410
C.7.23	Section 7.3	Recognized media types	410
C.7.24	Section 8.3.1	Collapsing margins	411
C.7.25	Section 8.3.1	Collapsing margins	411

C.7.26 Section 9.2.1 Block-level elements and block boxes . . . 411

C.7.27 Section 9.2.1.1 Anonymous block boxes 411

C.7.28 Section 9.2.1.1 Anonymous block boxes 412

C.7.29 Section 9.2.1.1 Anonymous block boxes 412

C.7.30 Section 9.2.1.1 Anonymous block boxes 412

C.7.31 Section 9.2.2 Inline-level elements and inline boxes . . . 412

C.7.32 Section 9.2.3 Run-in boxes 412

C.7.33 Section 9.2.4 The 'display' property 413

C.7.34 Section 9.2.4 The 'display' property 413

C.7.35 Section 9.3 Positioning schemes 414

C.7.36 Section 9.4 Normal flow 414

C.7.37 Section 9.3.2 Box offsets: 'top', 'right', 'bottom', 'left' . . . 414

C.7.38 Section 9.5 Floats 415

C.7.39 Section 9.5 Floats 415

C.7.40 Section 9.5.2 Controlling flow next to floats: the 'clear' property 416

C.7.41 Section 9.5.2 Controlling flow next to floats: the 'clear' property 416

C.7.42 Section 9.5.2 Controlling flow next to floats: the 'clear' property 416

C.7.43 Section 9.5.2 Controlling flow next to floats: the 'clear' property 417

C.7.44 Section 9.6.1 Fixed positioning 417

C.7.45 Section 9.9.1 Specifying the stack level: the 'z-index' property 417

C.7.46 Section 9.10 Text direction: the 'direction' and 'unicode-bidi' properties 417

C.7.47 Section 9.10 Text direction: the 'direction' and 'unicode-bidi' properties 418

C.7.48 Section 9.10 Text direction: the 'direction' and 'unicode-bidi' properties 418

C.7.49 Section 10.1 Definition of "containing block" 418

C.7.50 Section 10.2 Content width: the 'width' property 419

C.7.51 Section 10.2 Content width: the 'width' property 419

C.7.52 Section 10.2 Content width: the 'width' property 419

C.7.53 Section 10.5 Content height: the 'height' property 419

C.7.54 Section 10.5 Content height: the 'height' property 419

C.7.55 Section 10.6.7 'Auto' heights for block formatting context roots 419

C.7.56 Section 10.7 Minimum and maximum heights: 'min-height' and 'max-height' 420

C.7.57 Section 10.8 Line height calculations: the 'line-height' and 'vertical-align' properties 420

C.7.58 Section 10.8 Line height calculations: the 'line-height' and 'vertical-align' properties 421

C.7.59 Section 10.8.1 Leading and half-leading 421

C.7.60 Section 10.8.1 Leading and half-leading 422

C.7.61 Section 10.8.1 Leading and half-leading 422

C.7.62 Section 11.1 Overflow and clipping 422

C.7.63 Section 11.1.1 Overflow: the 'overflow' property 422

C.7.64 Section 11.1.1 Overflow: the 'overflow' property 423

C.7.65 Section 11.1.1 Overflow: the 'overflow' property 423

C.7.66 Section 11.1.2 Clipping: the 'clip' property 423

C.7.67 Section 12.5 Lists 423

C.7.68 Section 12.5.1 Lists: the 'list-style-type', 'list-style-image',
'list-style-position', and 'list-style' properties 424

C.7.69 Section 12.5.1 Lists: the 'list-style-type', 'list-style-image',
'list-style-position', and 'list-style' properties 424

C.7.70 Section 12.5.1 Lists: the 'list-style-type', 'list-style-image',
'list-style-position', and 'list-style' properties 424

C.7.71 Section 12.5.1 Lists: the 'list-style-type', 'list-style-image',
'list-style-position', and 'list-style' properties 424

C.7.72 Section 12.5.1 Lists: the 'list-style-type', 'list-style-image',
'list-style-position', and 'list-style' properties 424

C.7.73 Section 13.2 Page boxes: the @page rule 425

C.7.74 Section 13.2.2 Page selectors: selecting left, right, and first
pages 425

C.7.75 Section 13.3.2 Breaks inside elements: 'orphans', 'widows' 425

C.7.76 Section 13.3.3 Allowed page breaks 426

C.7.77 Section 15.3 Font family: the 'font-family' property . . . 426

C.7.78 Section 15.3.1 Generic font families 426

C.7.79 Section 15.6 Font boldness: the 'font-weight' property . . 427

C.7.80 Section 15.6 Font boldness: the 'font-weight' property . . 427

C.7.81 Section 15.7 Font size: the 'font-size' property 427

C.7.82 Section 16.1 Indentation: the 'text-indent' property 428

C.7.83 Section 16.1 Indentation: the 'text-indent' property 428

C.7.84 Section 16.2 Alignment: the 'text-align' property 428

C.7.85 Section 16.2 Alignment: the 'text-align' property 428

C.7.86 Section 16.3.1 Underlining, overlining, striking, and blinking: the
'text-decoration' property 429

C.7.87 Section 16.3.1 Underlining, overlining, striking, and blinking: the
'text-decoration' property 429

C.7.88 Section 16.4 Letter and word spacing: the 'letter-spacing' and
'word-spacing' properties 430

C.7.89 Section 16.6 White space: the 'white-space' property 430

C.7.90 Section 16.6.1 The 'white-space' processing model 431

C.7.91 Section 16.6.1 The 'white-space' processing model 431

C.7.92 Section 16.6.1 The 'white-space' processing model 431

C.7.93 Section 17.2 The CSS table model 431

C.7.94 Section 17.2.1 Anonymous table objects 431

C.7.95 Section 17.2.1 Anonymous table objects 431

C.7.96 Section 17.4 Tables in the visual formatting model 431

C.7.97 Section 17.4 Tables in the visual formatting model 432

C.7.98 Section 17.5.2.2 Automatic table layout 432

C.7.99 Section 17.5.3 Table height algorithms	433
C.7.100 Section 17.5.4 Horizontal alignment in a column	433
C.7.101 Section B.2 Informative references	433
C.7.102 Section D. Default style sheet for HTML 4	433
C.7.103 Section E.2 Painting order	434
C.7.104 Appendix G Grammar of CSS 2.1	434
Appendix D. Default style sheet for HTML 4	435
Appendix E. Elaborate description of Stacking Contexts	437
E.1 Definitions	437
E.2 Painting order	437
E.3 Notes	440
Appendix F. Full property table	441
Appendix G. Grammar of CSS 2.1	449
G.1 Grammar	449
G.2 Lexical scanner	451
G.3 Comparison of tokenization in CSS 2.1 and CSS1	453
G.4 Implementation note	454
Appendix I. Index	457

1 About the CSS 2.1 Specification

Contents

1.1 CSS 2.1 vs CSS 2	27
1.2 Reading the specification	28
1.3 How the specification is organized	28
1.4 Conventions	29
1.4.1 Document language elements and attributes	29
1.4.2 CSS property definitions	29
1.4.2.1 Value	29
1.4.2.2 Initial	31
1.4.2.3 Applies to	31
1.4.2.4 Inherited	31
1.4.2.5 Percentage values	31
1.4.2.6 Media groups	31
1.4.2.7 Computed value	32
1.4.3 Shorthand properties	32
1.4.4 Notes and examples	32
1.4.5 Images and long descriptions	33
1.5 Acknowledgments	33

1.1 CSS 2.1 vs CSS 2

The CSS community has gained significant experience with the CSS2 specification since it became a recommendation in 1998. Errors in the CSS2 specification have subsequently been corrected via the publication of various errata, but there has not yet been an opportunity for the specification to be changed based on experience gained.

While many of these issues will be addressed by the upcoming CSS3 specifications, the current state of affairs hinders the implementation and interoperability of CSS2. The CSS 2.1 specification attempts to address this situation by:

- Maintaining compatibility with those portions of CSS2 that are widely accepted and implemented.
- Incorporating all published CSS2 errata.
- Where implementations overwhelmingly differ from the CSS2 specification, modifying the specification to be in accordance with generally accepted practice.
- Removing CSS2 features which, by virtue of not having been implemented, have been rejected by the CSS community. CSS 2.1 aims to reflect what CSS features are reasonably widely implemented for HTML and XML languages in general (rather than *only* for a particular XML language, or *only* for HTML).
- Removing CSS2 features that will be obsoleted by CSS3, thus encouraging

adoption of the proposed CSS3 features in their place.

- Adding a (very) small number of new property values, [p. 341] when implementation experience has shown that they are needed for implementing CSS2.

Thus, while it is not the case that a CSS2 style sheet is necessarily forwards-compatible with CSS 2.1, it is the case that a style sheet restricting itself to CSS 2.1 features is more likely to find a compliant user agent today and to preserve forwards compatibility in the future. While breaking forward compatibility is not desirable, we believe the advantages to the revisions in CSS 2.1 are worthwhile.

CSS 2.1 is derived from and is intended to replace CSS2. Some parts of CSS2 are unchanged in CSS 2.1, some parts have been altered, and some parts removed. The removed portions may be used in a future CSS3 specification. Future specs should refer to CSS 2.1 (unless they need features from CSS2 which have been dropped in CSS 2.1, and then they should only reference CSS2 for those features, or preferably reference such feature(s) in the respective CSS3 Module that includes those feature(s)).

1.2 Reading the specification

This section is non-normative.

This specification has been written with two types of readers in mind: CSS authors and CSS implementors. We hope the specification will provide authors with the tools they need to write efficient, attractive, and accessible documents, without overexposing them to CSS's implementation details. Implementors, however, should find all they need to build conforming user agents [p. 47]. The specification begins with a general presentation of CSS and becomes more and more technical and specific towards the end. For quick access to information, a general table of contents, specific tables of contents at the beginning of each section, and an index provide easy navigation, in both the electronic and printed versions.

The specification has been written with two modes of presentation in mind: electronic and printed. Although the two presentations will no doubt be similar, readers will find some differences. For example, links will not work in the printed version (obviously), and page numbers will not appear in the electronic version. In case of a discrepancy, the electronic version is considered the authoritative version of the document.

1.3 How the specification is organized

This section is non-normative.

The specification is organized into the following sections:

Section 2: An introduction to CSS 2.1

The introduction includes a brief tutorial on CSS 2.1 and a discussion of design principles behind CSS 2.1.

Sections 3 - 18: CSS 2.1 reference manual.

The bulk of the reference manual consists of the CSS 2.1 language reference. This reference defines what may go into a CSS 2.1 style sheet (syntax, properties, property values) and how user agents must interpret these style sheets in order to claim conformance [p. 47] .

Appendixes:

Appendixes contain information about aural properties [p. 305] (non-normative), a sample style sheet for HTML 4 [p. 435] , changes from CSS2 [p. 329] , the grammar of CSS 2.1 [p. 449] , a list of normative and informative references [p. 325] , and two indexes: one for properties [p. 441] and one general index [p. 457] .

1.4 Conventions

1.4.1 Document language elements and attributes

- CSS property and pseudo-class names are delimited by single quotes.
- CSS values are delimited by single quotes.
- Document language attribute names are in lowercase letters and delimited by double quotes.

1.4.2 CSS property definitions

Each CSS property definition begins with a summary of key information that resembles the following:

'property-name'

<i>Value:</i>	legal values & syntax
<i>Initial:</i>	initial value
<i>Applies to:</i>	elements this property applies to
<i>Inherited:</i>	whether the property is inherited
<i>Percentages:</i>	how percentage values are interpreted
<i>Media:</i>	which media groups the property applies to
<i>Computed value:</i>	how to compute the computed value

1.4.2.1 Value

This part specifies the set of valid values for the property whose name is 'property-name'. A property value can have one or more components. Component value types are designated in several ways:

1. keyword values (e.g., auto, disc, etc.)
2. basic data types, which appear between "<" and ">" (e.g., <length>, <percentage>, etc.). In the electronic version of the document, each instance of a basic data type links to its definition.

3. types that have the same range of values as a property bearing the same name (e.g., `<'border-width'>` `<'background-attachment'>`, etc.). In this case, the type name is the property name (complete with quotes) between "<" and ">" (e.g., `<'border-width'>`). Such a type does **not** include the value 'inherit'. In the electronic version of the document, each instance of this type of non-terminal links to the corresponding property definition.
4. non-terminals that do not share the same name as a property. In this case, the non-terminal name appears between "<" and ">", as in `<border-width>`. Notice the distinction between `<border-width>` and `<'border-width'>`; the latter is defined in terms of the former. The definition of a non-terminal is located near its first appearance in the specification. In the electronic version of the document, each instance of this type of value links to the corresponding value definition.

Other words in these definitions are keywords that must appear literally, without quotes (e.g., red). The slash (/) and the comma (,) must also appear literally.

Component values may be arranged into property values as follows:

- Several juxtaposed words mean that all of them must occur, in the given order.
- A bar (|) separates two or more alternatives: exactly one of them must occur.
- A double bar (||) separates two or more options: one or more of them must occur, in any order.
- A double ampersand (&&) separates two or more components, all of which must occur, in any order.
- Brackets ([]) are for grouping.

Juxtaposition is stronger than the double ampersand, the double ampersand is stronger than the double bar, and the double bar is stronger than the bar. Thus, the following lines are equivalent:

```
a b | c || d && e f
[ a b ] | [ c || [ d && [ e f ] ] ]
```

Every type, keyword, or bracketed group may be followed by one of the following modifiers:

- An asterisk (*) indicates that the preceding type, word, or group occurs zero or more times.
- A plus (+) indicates that the preceding type, word, or group occurs one or more times.
- A question mark (?) indicates that the preceding type, word, or group is optional.
- A pair of numbers in curly braces ({A,B}) indicates that the preceding type, word, or group occurs at least A and at most B times.

The following examples illustrate different value types:

Value: N | NW | NE
Value: [<length> | thick | thin]{1,4}
Value: [<family-name> ,]* <family-name>
Value: <uri>? <color> [/ <color>]?
Value: <uri> || <color>
Value: inset? && [<length>{2,4} && <color>?]

Component values are specified in terms of tokens, as described in Appendix G.2 [p. 451]. As the grammar allows spaces between tokens in the components of the *expr* production, spaces may appear between tokens in property values.

Note: In many cases, spaces will in fact be *required* between tokens in order to distinguish them from each other. For example, the value '1em2em' would be parsed as a single DIMEN token with the number '1' and the identifier 'em2em', which is an invalid unit. In this case, a space would be required before the '2' to get this parsed as the two lengths '1em' and '2em'.

1.4.2.2 *Initial*

This part specifies the property's initial value. Please consult the section on the cascade [p. 99] for information about the interaction between style sheet-specified, inherited, and initial property values.

1.4.2.3 *Applies to*

This part lists the elements to which the property applies. All elements are considered to have all properties, but some properties have no rendering effect on some types of elements. For example, the 'clear' property only affects block-level elements.

1.4.2.4 *Inherited*

This part indicates whether the value of the property is inherited from an ancestor element. Please consult the section on the cascade [p. 99] for information about the interaction between style sheet-specified, inherited, and initial property values.

1.4.2.5 *Percentage values*

This part indicates how percentages should be interpreted, if they occur in the value of the property. If "N/A" appears here, it means that the property does not accept percentages in its values.

1.4.2.6 *Media groups*

This part indicates the media groups [p. 110] to which the property applies. Information about media groups is non-normative.

1.4.2.7 Computed value

This part describes the computed value for the property. See the section on computed values [p. 100] for how this definition is used.

1.4.3 Shorthand properties

Some properties are *shorthand properties*, meaning that they allow authors to specify the values of several properties with a single property.

For instance, the 'font' property is a shorthand property for setting 'font-style', 'font-variant', 'font-weight', 'font-size', 'line-height', and 'font-family' all at once.

When values are omitted from a shorthand form, each "missing" property is assigned its initial value (see the section on the cascade [p. 99]).

Example(s):

The multiple style rules of this example:

```
h1 {
  font-weight: bold;
  font-size: 12pt;
  line-height: 14pt;
  font-family: Helvetica;
  font-variant: normal;
  font-style: normal;
}
```

may be rewritten with a single shorthand property:

```
h1 { font: bold 12pt/14pt Helvetica }
```

In this example, 'font-variant', and 'font-style' take their initial values.

1.4.4 Notes and examples

All examples that illustrate illegal usage are clearly marked as "ILLEGAL EXAMPLE".

HTML examples lacking DOCTYPE declarations are SGML Text Entities conforming to the HTML 4.01 Strict DTD [HTML4]. Other HTML examples conform to the DTDs given in the examples.

All notes are informative only.

Examples and notes are marked within the source HTML [p. 43] for the specification and CSS user agents will render them specially.

1.4.5 Images and long descriptions

Most images in the electronic version of this specification are accompanied by "long descriptions" of what they represent. A link to the long description is denoted by a "[D]" after the image.

Images and long descriptions are informative only.

1.5 Acknowledgments

This section is non-normative.

CSS 2.1 is based on CSS2. See the acknowledgments section of CSS2 [p. ??] for the people that contributed to CSS2.

We would like to thank the following people who, through their input and feedback on the www-style mailing list, have helped us with the creation of this specification: Andrew Clover, Bernd Mielke, C. Bottelier, Christian Roth, Christoph Päper, Claus Färber, Coises, Craig Salla, Darren Ferguson, Dylan Schiemann, Etan Wexler, George Lund, James Craig, Jan Eirik Olufsen, Jan Roland Eriksson, Joris Huizer, Joshua Prowse, Kai Lahmann, Kevin Smith, Lachlan Cannon, Lars Knoll, Lauri Raittila, Mark Gallagher, Michael Day, Peter Sheerin, Rijk van Geijtenbeek, Robin Berjon, Scott Montgomery, Shelby Moore, Stuart Ballard, Tom Gilder, Vadim Plessky, and the Open eBook Publication Structure Working Group Editors. We would also like to thank Gary Schnabl, Glenn Adams and Susan Lesch who helped proofread this document.

In addition, we would like to extend special thanks to fantasai, Ada Chan and Boris Zbarsky who have contributed significant time to CSS 2.1, and to Kimberly Blessing for help with the editing.

2 Introduction to CSS 2.1

Contents

2.1 A brief CSS 2.1 tutorial for HTML	35
2.2 A brief CSS 2.1 tutorial for XML	38
2.3 The CSS 2.1 processing model	39
2.3.1 The canvas	40
2.3.2 CSS 2.1 addressing model	40
2.4 CSS design principles	41

2.1 A brief CSS 2.1 tutorial for HTML

This section is non-normative.

In this tutorial, we show how easy it can be to design simple style sheets. For this tutorial, you will need to know a little HTML (see [HTML4]) and some basic desktop publishing terminology.

We begin with a small HTML document:

```
<!DOCTYPE HTML PUBLIC "-//W3C//DTD HTML 4.01//EN">
<HTML>
  <HEAD>
    <TITLE>Bach's home page</TITLE>
  </HEAD>
  <BODY>
    <H1>Bach's home page</H1>
    <P>Johann Sebastian Bach was a prolific composer.
  </BODY>
</HTML>
```

To set the text color of the H1 elements to red, you can write the following CSS rules:

```
h1 { color: red }
```

A CSS rule consists of two main parts: selector [p. 77] ('h1') and declaration ('color: red'). In HTML, element names are case-insensitive so 'h1' works just as well as 'H1'. The declaration has two parts: property name ('color') and property value ('red'). While the example above tries to influence only one of the properties needed for rendering an HTML document, it qualifies as a style sheet on its own. Combined with other style sheets (one fundamental feature of CSS is that style sheets are combined), the rule will determine the final presentation of the document.

The HTML 4 specification defines how style sheet rules may be specified for HTML documents: either within the HTML document, or via an external style sheet. To put the style sheet into the document, use the STYLE element:

```

<!DOCTYPE HTML PUBLIC "-//W3C//DTD HTML 4.01//EN">
<HTML>
  <HEAD>
    <TITLE>Bach's home page</TITLE>
    <STYLE type="text/css">
      h1 { color: red }
    </STYLE>
  </HEAD>
  <BODY>
    <H1>Bach's home page</H1>
    <P>Johann Sebastian Bach was a prolific composer.
  </BODY>
</HTML>

```

For maximum flexibility, we recommend that authors specify external style sheets; they may be changed without modifying the source HTML document, and they may be shared among several documents. To link to an external style sheet, you can use the LINK element:

```

<!DOCTYPE HTML PUBLIC "-//W3C//DTD HTML 4.01//EN">
<HTML>
  <HEAD>
    <TITLE>Bach's home page</TITLE>
    <LINK rel="stylesheet" href="bach.css" type="text/css">
  </HEAD>
  <BODY>
    <H1>Bach's home page</H1>
    <P>Johann Sebastian Bach was a prolific composer.
  </BODY>
</HTML>

```

The LINK element specifies:

- the type of link: to a "stylesheet".
- the location of the style sheet via the "href" attribute.
- the type of style sheet being linked: "text/css".

To show the close relationship between a style sheet and the structured markup, we continue to use the STYLE element in this tutorial. Let's add more colors:

```

<!DOCTYPE HTML PUBLIC "-//W3C//DTD HTML 4.01//EN">
<HTML>
  <HEAD>
    <TITLE>Bach's home page</TITLE>
    <STYLE type="text/css">
      body { color: black; background: white }
      h1 { color: red; background: white }
    </STYLE>
  </HEAD>
  <BODY>
    <H1>Bach's home page</H1>
    <P>Johann Sebastian Bach was a prolific composer.
  </BODY>
</HTML>

```

The style sheet now contains four rules: the first two set the color and background of the BODY element (it's a good idea to set the text color and background color together), while the last two set the color and the background of the H1 element. Since no color has been specified for the P element, it will inherit the color from its parent element, namely BODY. The H1 element is also a child element of BODY but the second rule overrides the inherited value. In CSS there are often such conflicts between different values, and this specification describes how to resolve them.

CSS 2.1 has more than 90 properties, including 'color'. Let's look at some of the others:

```
<!DOCTYPE HTML PUBLIC "-//W3C//DTD HTML 4.01//EN">
<HTML>
  <HEAD>
    <TITLE>Bach's home page</TITLE>
    <STYLE type="text/css">
      body {
        font-family: "Gill Sans", sans-serif;
        font-size: 12pt;
        margin: 3em;
      }
    </STYLE>
  </HEAD>
  <BODY>
    <H1>Bach's home page</H1>
    <P>Johann Sebastian Bach was a prolific composer.
  </BODY>
</HTML>
```

The first thing to notice is that several declarations are grouped within a block enclosed by curly braces ({...}), and separated by semicolons, though the last declaration may also be followed by a semicolon.

The first declaration on the BODY element sets the font family to "Gill Sans". If that font is not available, the user agent (often referred to as a "browser") will use the 'sans-serif' font family which is one of five generic font families which all users agents know. Child elements of BODY will inherit the value of the 'font-family' property.

The second declaration sets the font size of the BODY element to 12 points. The "point" unit is commonly used in print-based typography to indicate font sizes and other length values. It's an example of an absolute unit which does not scale relative to the environment.

The third declaration uses a relative unit which scales with regard to its surroundings. The "em" unit refers to the font size of the element. In this case the result is that the margins around the BODY element are three times wider than the font size.

2.2 A brief CSS 2.1 tutorial for XML

This section is non-normative.

CSS can be used with any structured document format, for example with applications of the eXtensible Markup Language [XML10]. In fact, XML depends more on style sheets than HTML, since authors can make up their own elements that user agents do not know how to display.

Here is a simple XML fragment:

```
<ARTICLE>
  <HEADLINE>Fredrick the Great meets Bach</HEADLINE>
  <AUTHOR>Johann Nikolaus Forkel</AUTHOR>
  <PARA>
    One evening, just as he was getting his
    <INSTRUMENT>flute</INSTRUMENT> ready and his
    musicians were assembled, an officer brought him a list of
    the strangers who had arrived.
  </PARA>
</ARTICLE>
```

To display this fragment in a document-like fashion, we must first declare which elements are inline-level (i.e., do not cause line breaks) and which are block-level (i.e., cause line breaks).

```
INSTRUMENT { display: inline }
ARTICLE, HEADLINE, AUTHOR, PARA { display: block }
```

The first rule declares INSTRUMENT to be inline and the second rule, with its comma-separated list of selectors, declares all the other elements to be block-level. Element names in XML are case-sensitive, so a selector written in lowercase (e.g., 'instrument') is different from uppercase (e.g., 'INSTRUMENT').

One way of linking a style sheet to an XML document is to use a processing instruction:

```
<?xml-stylesheet type="text/css" href="bach.css"?>
<ARTICLE>
  <HEADLINE>Fredrick the Great meets Bach</HEADLINE>
  <AUTHOR>Johann Nikolaus Forkel</AUTHOR>
  <PARA>
    One evening, just as he was getting his
    <INSTRUMENT>flute</INSTRUMENT> ready and his
    musicians were assembled, an officer brought him a list of
    the strangers who had arrived.
  </PARA>
</ARTICLE>
```

A visual user agent could format the above example as:

Fredrick the Great meets Bach
 Johann Nikolaus Forkel
 One evening, just as he was getting his flute ready and his musicians were assembled, an officer brought him a list of the strangers who had arrived.

Notice that the word "flute" remains within the paragraph since it is the content of the inline element INSTRUMENT.

Still, the text is not formatted the way you would expect. For example, the headline font size should be larger than then the rest of the text, and you may want to display the author's name in italic:

```
INSTRUMENT { display: inline }
ARTICLE, HEADLINE, AUTHOR, PARA { display: block }
HEADLINE { font-size: 1.3em }
AUTHOR { font-style: italic }
ARTICLE, HEADLINE, AUTHOR, PARA { margin: 0.5em }
```

A visual user agent could format the above example as:

Fredrick the Great meets Bach
Johann Nikolaus Forkel
 One evening, just as he was getting his flute ready and his musicians were assembled, an officer brought him a list of the strangers who had arrived.

Adding more rules to the style sheet will allow you to further describe the presentation of the document.

2.3 The CSS 2.1 processing model

This section up to but not including its subsections is non-normative.

This section presents one possible model of how user agents that support CSS work. This is only a conceptual model; real implementations may vary.

In this model, a user agent processes a source by going through the following steps:

1. Parse the source document and create a document tree [p. 45] .
2. Identify the target media type [p. 107] .
3. Retrieve all style sheets associated with the document that are specified for the target media type [p. 107] .

4. Annotate every element of the document tree by assigning a single value to every property [p. 59] that is applicable to the target media type [p. 107] . Properties are assigned values according to the mechanisms described in the section on cascading and inheritance [p. 99] .

Part of the calculation of values depends on the formatting algorithm appropriate for the target media type [p. 107] . For example, if the target medium is the screen, user agents apply the visual formatting model [p. 127] .

5. From the annotated document tree, generate a *formatting structure*. Often, the formatting structure closely resembles the document tree, but it may also differ significantly, notably when authors make use of pseudo-elements and generated content. First, the formatting structure need not be "tree-shaped" at all -- the nature of the structure depends on the implementation. Second, the formatting structure may contain more or less information than the document tree. For instance, if an element in the document tree has a value of 'none' for the 'display' property, that element will generate nothing in the formatting structure. A list element, on the other hand, may generate more information in the formatting structure: the list element's content and list style information (e.g., a bullet image).

Note that the CSS user agent does not alter the document tree during this phase. In particular, content generated due to style sheets is not fed back to the document language processor (e.g., for reparsing).

6. Transfer the formatting structure to the target medium (e.g., print the results, display them on the screen, render them as speech, etc.).

2.3.1 The canvas

For all media, the term *canvas* describes "the space where the formatting structure is rendered." The canvas is infinite for each dimension of the space, but rendering generally occurs within a finite region of the canvas, established by the user agent according to the target medium. For instance, user agents rendering to a screen generally impose a minimum width and choose an initial width based on the dimensions of the viewport [p. 128] . User agents rendering to a page generally impose width and height constraints. Aural user agents may impose limits in audio space, but not in time.

2.3.2 CSS 2.1 addressing model

CSS 2.1 selectors [p. 77] and properties allow style sheets to refer to the following parts of a document or user agent:

- Elements in the document tree and certain relationships between them (see the section on selectors [p. 77]).
- Attributes of elements in the document tree, and values of those attributes (see the section on attribute selectors [p. 82]).
- Some parts of element content (see the `:first-line` [p. 94] and `:first-letter` [p. 94] pseudo-elements).

- Elements of the document tree when they are in a certain state (see the section on pseudo-classes [p. 87]).
- Some aspects of the canvas [p. 40] where the document will be rendered.
- Some system information (see the section on user interface [p. 297]).

2.4 CSS design principles

This section is non-normative.

CSS 2.1, as CSS2 and CSS1 before it, is based on a set of design principles:

- **Forward and backward compatibility.** CSS 2.1 user agents will be able to understand CSS1 style sheets. CSS1 user agents will be able to read CSS 2.1 style sheets and discard parts they do not understand. Also, user agents with no CSS support will be able to display style-enhanced documents. Of course, the stylistic enhancements made possible by CSS will not be rendered, but all content will be presented.
- **Complementary to structured documents.** Style sheets complement structured documents (e.g., HTML and XML applications), providing stylistic information for the marked-up text. It should be easy to change the style sheet with little or no impact on the markup.
- **Vendor, platform, and device independence.** Style sheets enable documents to remain vendor, platform, and device independent. Style sheets themselves are also vendor and platform independent, but CSS 2.1 allows you to target a style sheet for a group of devices (e.g., printers).
- **Maintainability.** By pointing to style sheets from documents, webmasters can simplify site maintenance and retain consistent look and feel throughout the site. For example, if the organization's background color changes, only one file needs to be changed.
- **Simplicity.** CSS is a simple style language which is human readable and writable. The CSS properties are kept independent of each other to the largest extent possible and there is generally only one way to achieve a certain effect.
- **Network performance.** CSS provides for compact encodings of how to present content. Compared to images or audio files, which are often used by authors to achieve certain rendering effects, style sheets most often decrease the content size. Also, fewer network connections have to be opened which further increases network performance.
- **Flexibility.** CSS can be applied to content in several ways. The key feature is the ability to cascade style information specified in the default (user agent) style sheet, user style sheets, linked style sheets, the document head, and in attributes for the elements forming the document body.
- **Richness.** Providing authors with a rich set of rendering effects increases the richness of the Web as a medium of expression. Designers have been longing for functionality commonly found in desktop publishing and slide-show applica-

tions. Some of the requested rendering effects conflict with device independence, but CSS 2.1 goes a long way toward granting designers their requests.

- **Alternative language bindings.** The set of CSS properties described in this specification form a consistent formatting model for visual and aural presentations. This formatting model can be accessed through the CSS language, but bindings to other languages are also possible. For example, a JavaScript program may dynamically change the value of a certain element's 'color' property.
- **Accessibility.** Several CSS features will make the Web more accessible to users with disabilities:
 - Properties to control font appearance allow authors to eliminate inaccessible bit-mapped text images.
 - Positioning properties allow authors to eliminate mark-up tricks (e.g., invisible images) to force layout.
 - The semantics of `!important` rules mean that users with particular presentation requirements can override the author's style sheets.
 - The 'inherit' value for all properties improves cascading generality and allows for easier and more consistent style tuning.
 - Improved media support, including media groups and the braille, embossed, and tty media types, will allow users and authors to tailor pages to those devices.

Note. For more information about designing accessible documents using CSS and HTML, see [WAI-PAGEAUTH].

3 Conformance: Requirements and Recommendations

Contents

3.1 Definitions	43
3.2 UA Conformance	47
3.3 Error conditions	48
3.4 The text/css content type	48

3.1 Definitions

The key words "MUST", "MUST NOT", "REQUIRED", "SHALL", "SHALL NOT", "SHOULD", "SHOULD NOT", "RECOMMENDED", "MAY", and "OPTIONAL" in this document are to be interpreted as described in RFC 2119 (see [RFC2119]). However, for readability, these words do not appear in all uppercase letters in this specification.

At times, this specification recommends good practice for authors and user agents. These recommendations are not normative and conformance with this specification does not depend on their realization. These recommendations contain the expression "We recommend ...", "This specification recommends ...", or some similar wording.

The fact that a feature is marked as deprecated (namely the 'aural' [p. 305] keyword) or going to be deprecated in CSS3 (namely the system colors [p. 298]) also has no influence on conformance. (For example, 'aural' is marked as non-normative, so UAs do not need to support it; the system colors are normative, so UAs must support them.)

All sections of this specification, including appendices, are normative unless otherwise noted.

Examples and notes [p. 32] are not normative.

Example(s):

Examples usually have the word "example" near their start ("Example:", "The following example", "For example," etc.) and are shown in the color maroon, like this paragraph.

Notes start with the word "Note," are indented and shown in green, like this paragraph.

Figures are for illustration only. They are not reference renderings, unless explicitly stated.

Style sheet

A set of statements that specify presentation of a document.

Style sheets may have three different origins: author [p. 46] , user [p. 46] , and user agent [p. 46] . The interaction of these sources is described in the section on cascading and inheritance [p. 99] .

Valid style sheet

The validity of a style sheet depends on the level of CSS used for the style sheet. All valid CSS1 style sheets are valid CSS 2.1 style sheets, but some changes from CSS1 mean that a few CSS1 style sheets will have slightly different semantics in CSS 2.1. Some features in CSS2 are not part of CSS 2.1, so not all CSS2 style sheets are valid CSS 2.1 style sheets.

A valid CSS 2.1 style sheet must be written according to the grammar of CSS 2.1 [p. 449] . Furthermore, it must contain only at-rules, property names, and property values defined in this specification. An **illegal** (invalid) at-rule, property name, or property value is one that is not valid.

Source document

The document to which one or more style sheets apply. This is encoded in some language that represents the document as a tree of elements [p. 44] . Each element consists of a name that identifies the type of element, optionally a number of attributes [p. 45] , and a (possibly empty) content [p. 45] . For example, the source document could be an XML or SGML instance.

Document language

The encoding language of the source document (e.g., HTML, XHTML, or SVG). CSS is used to describe the presentation of document languages and CSS does not change the underlying semantics of the document languages.

Element

(An SGML term, see [ISO8879].) The primary syntactic constructs of the document language. Most CSS style sheet rules use the names of these elements (such as P, TABLE, and OL in HTML) to specify how the elements should be rendered.

Replaced element

An element whose content is outside the scope of the CSS formatting model, such as an image, embedded document, or applet. For example, the content of the HTML IMG element is often replaced by the image that its "src" attribute designates. Replaced elements often have intrinsic dimensions: an intrinsic width, an intrinsic height, and an intrinsic ratio. For example, a bitmap image has an intrinsic width and an intrinsic height specified in absolute units (from which the intrinsic ratio can obviously be determined). On the other hand, other documents may not have any intrinsic dimensions (for example, a blank HTML document).

User agents may consider a replaced element to not have any intrinsic dimensions if it is believed that those dimensions could leak sensitive information to a third party. For example, if an HTML document changed intrinsic size depending on the user's bank balance, then the UA might want to act as if that resource had no intrinsic dimensions.

The content of replaced elements is not considered in the CSS rendering model.

Intrinsic dimensions

The width and height as defined by the element itself, not imposed by the surroundings. CSS does not define how the intrinsic dimensions are found. In CSS 2.1 only replaced elements can come with intrinsic dimensions. For raster images without reliable resolution information, a size of 1 px unit per image source pixel must be assumed.

Attribute

A value associated with an element, consisting of a name, and an associated (textual) value.

Content

The content associated with an element in the source document. Some elements have no content, in which case they are called **empty**. The content of an element may include text, and it may include a number of sub-elements, in which case the element is called the **parent** of those sub-elements.

Ignore

This term has two slightly different meanings in this specification. First, a CSS parser must follow certain rules when it discovers unknown or illegal syntax in a style sheet. The parser must then ignore certain parts of the style sheets. The exact rules for which parts must be ignored are described in these sections (Declarations and properties, [p. 59] Rules for handling parsing errors, [p. 60] Unsupported Values [p. 70]) or may be explained in the text where the term "ignore" appears. Second, a user agent may (and, in some cases must) disregard certain properties or values in the style sheet, even if the syntax is legal. For example, table-column elements cannot affect the font of the column, so the font properties must be ignored.

Rendered content

The content of an element after the rendering that applies to it according to the relevant style sheets has been applied. How a replaced element's content is rendered is not defined by this specification. Rendered content may also be alternate text for an element (e.g., the value of the XHTML "alt" attribute), and may include items inserted implicitly or explicitly by the style sheet, such as bullets, numbering, etc.

Document tree

The tree of elements encoded in the source document. Each element in this tree has exactly one parent, with the exception of the **root** element, which has none.

Child

An element A is called the child of element B if and only if B is the parent of A.

Descendant

An element A is called a descendant of an element B, if either (1) A is a child of B, or (2) A is the child of some element C that is a descendant of B.

Ancestor

An element A is called an ancestor of an element B, if and only if B is a descendant of A.

Sibling

An element A is called a sibling of an element B, if and only if B and A share the same parent element. Element A is a preceding sibling if it comes before B in the document tree. Element B is a following sibling if it comes after A in the document tree.

Preceding element

An element A is called a preceding element of an element B, if and only if (1) A is an ancestor of B or (2) A is a preceding sibling of B.

Following element

An element A is called a following element of an element B, if and only if B is a preceding element of A.

Author

An author is a person who writes documents and associated style sheets. An **authoring tool** is a User Agent [p. 46] that generates style sheets.

User

A user is a person who interacts with a user agent to view, hear, or otherwise use a document and its associated style sheet. The user may provide a personal style sheet that encodes personal preferences.

User agent (UA)

A user agent is any program that interprets a document written in the document language and applies associated style sheets according to the terms of this specification. A user agent may display a document, read it aloud, cause it to be printed, convert it to another format, etc.

An HTML user agent is one that supports the HTML 2.x, HTML 3.x, or HTML 4.x specifications. A user agent that supports XHTML [XHTML], but not HTML (as listed in the previous sentence) is not considered an HTML user agent for the purpose of conformance with this specification.

Property

CSS defines a finite set of parameters, called properties, that direct the rendering of a document. Each property has a name (e.g., 'color', 'font', or 'border') and a value (e.g., 'red', '12pt Times', or 'dotted'). Properties are attached to various parts of the document and to the page on which the document is to be displayed by the mechanisms of specificity, cascading, and inheritance (see the chapter on Assigning property values, Cascading, and Inheritance [p. 99]).

Here is an example of a source document written in HTML:

```
<!DOCTYPE HTML PUBLIC "-//W3C//DTD HTML 4.01//EN">
<HTML>
  <TITLE>My home page</TITLE>
  <BODY>
    <H1>My home page</H1>
    <P>Welcome to my home page! Let me tell you about my favorite
      composers:
    <UL>
      <LI> Elvis Costello
      <LI> Johannes Brahms
```

```

    <LI> Georges Brassens
  </UL>
</BODY>
</HTML>

```

This results in the following tree:

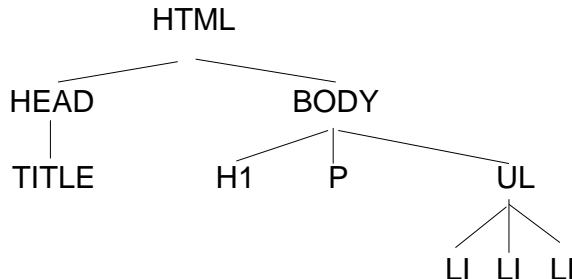

According to the definition of HTML 4, HEAD elements will be inferred during parsing and become part of the document tree even if the "head" tags are not in the document source. Similarly, the parser knows where the P and LI elements end, even though there are no </p> and tags in the source.

Documents written in XHTML (and other XML-based languages) behave differently: there are no inferred elements and all elements must have end tags.

3.2 UA Conformance

This section defines conformance with the CSS 2.1 specification only. There may be other levels of CSS in the future that may require a user agent to implement a different set of features in order to conform.

In general, the following points must be observed by a user agent claiming conformance to this specification:

1. It must recognize one or more of the CSS 2.1 media types [p. 107] .
2. For each source document, it must attempt to retrieve all associated style sheets that are appropriate for the recognized media types. If it cannot retrieve all associated style sheets (for instance, because of network errors), it must display the document using those it can retrieve.
3. It must parse the style sheets according to this specification. In particular, it must recognize all at-rules, blocks, declarations, and selectors (see the grammar of CSS 2.1 [p. 449]). If a user agent encounters a property that applies for a supported media type, the user agent must parse the value according to the property definition. This means that the user agent must accept all valid values and must ignore declarations with invalid values. User agents must ignore rules that apply to unsupported media types [p. 107] .
4. For each element in a document tree [p. 45] , it must assign a value for every property according to the property's definition and the rules of cascading and inheritance [p. 99] .
5. If the source document comes with alternate style sheet sets (such as with the

"alternate" keyword in HTML 4 [HTML4]), the UA must allow the user to select which style sheet set the UA should apply.

6. The UA must allow the user to turn off the influence of author style sheets.

Not every user agent must observe every point, however:

- An application that reads style sheets without rendering any content (e.g., a CSS 2.1 validator) must respect points 1-3.
- An authoring tool is only required to output valid style sheets [p. 44]
- A user agent that *renders* a document with associated style sheets must respect points 1-6 and render the document according to the media-specific requirements set forth in this specification. Values [p. 100] may be approximated when required by the user agent.

The inability of a user agent to implement part of this specification due to the limitations of a particular device (e.g., a user agent cannot render colors on a monochrome monitor or page) does not imply non-conformance.

UAs must allow users to specify a file that contains the user style sheet. UAs that run on devices without any means of writing or specifying files are exempted from this requirement. Additionally, UAs may offer other means to specify user preferences, for example, through a GUI.

CSS 2.1 does not define which properties apply to form controls and frames, or how CSS can be used to style them. User agents may apply CSS properties to these elements. Authors are recommended to treat such support as experimental. A future level of CSS may specify this further.

3.3 Error conditions

In general, this document specifies error handling behavior throughout the specification. For example, see the rules for handling parsing errors [p. 60] .

3.4 The text/css content type

CSS style sheets that exist in separate files are sent over the Internet as a sequence of bytes accompanied by encoding information. The structure of the transmission, termed a **message entity**, is defined by RFC 2045 and RFC 2616 (see [RFC2045] and [RFC2616]). A message entity with a content type of "text/css" represents an independent CSS document. The "text/css" content type has been registered by RFC 2318 ([RFC2318]).

4 Syntax and basic data types

Contents

4.1 Syntax	49
4.1.1 Tokenization	50
4.1.2 Keywords	53
4.1.2.1 Vendor-specific extensions	54
4.1.2.2 Informative Historical Notes	54
4.1.3 Characters and case	55
4.1.4 Statements	56
4.1.5 At-rules	57
4.1.6 Blocks	57
4.1.7 Rule sets, declaration blocks, and selectors	58
4.1.8 Declarations and properties	59
4.1.9 Comments	60
4.2 Rules for handling parsing errors	60
4.3 Values	63
4.3.1 Integers and real numbers	63
4.3.2 Lengths	63
4.3.3 Percentages	66
4.3.4 URLs and URIs	67
4.3.5 Counters	68
4.3.6 Colors	68
4.3.7 Strings	70
4.3.8 Unsupported Values	70
4.4 CSS style sheet representation	71
4.4.1 Referring to characters not represented in a character encoding	74

4.1 Syntax

This section describes a grammar (and *forward-compatible parsing* rules) common to any level of CSS (including CSS 2.1). Future updates of CSS will adhere to this core syntax, although they may add additional syntactic constraints.

These descriptions are normative. They are also complemented by the normative grammar rules presented in Appendix G [p. 449] .

In this specification, the expressions "immediately before" or "immediately after" mean with no intervening white space or comments.

4.1.1 Tokenization

All levels of CSS — level 1, level 2, and any future levels — use the same core syntax. This allows UAs to parse (though not completely understand) style sheets written in levels of CSS that did not exist at the time the UAs were created. Designers can use this feature to create style sheets that work with older user agents, while also exercising the possibilities of the latest levels of CSS.

At the lexical level, CSS style sheets consist of a sequence of tokens. The list of tokens for CSS is as follows. The definitions use Lex-style regular expressions. Octal codes refer to ISO 10646 ([ISO10646]). As in Lex, in case of multiple matches, the longest match determines the token.

Token	Definition
IDENT	<i>{ident}</i>
ATKEYWORD	@ <i>{ident}</i>
STRING	<i>{string}</i>
BAD_STRING	<i>{badstring}</i>
BAD_URI	<i>{baduri}</i>
BAD_COMMENT	<i>{badcomment}</i>
HASH	# <i>{name}</i>
NUMBER	<i>{num}</i>
PERCENTAGE	<i>{num}</i> %
DIMENSION	<i>{num}{ident}</i>
URI	url\(<i>{w}{string}{w}</i> \) url\(<i>{w}</i> ([!#\$%&*-\[\]\~] <i>{nonascii}</i> <i>{escape}</i>)* <i>{w}</i> \)
UNICODE-RANGE	u\[0-9a-f\]{1,6}(-\[0-9a-f\]{1,6})?
CDO	<!--
CDC	-->
:	:
;	;
{	\{
}	\}
(\(
)	\)
[\[
]	\]
S	[\t\r\n\f]+
COMMENT	\/\^[^*]**+([^\/*][^*]**+)*\/
FUNCTION	<i>{ident}</i> \(
INCLUDES	~=
DASHMATCH	=
DELIM	<i>any other character not matched by the above rules, and neither a single nor a double quote</i>

The macros in curly braces ({} above are defined as follows:

Macro	Definition
ident	<code>[-]?{nmstart}{nmchar}*</code>
name	<code>{nmchar}+</code>
nmstart	<code>[_a-z] {nonascii} {escape}</code>
nonascii	<code>[^\0-\237]</code>
unicode	<code>\\[0-9a-f]{1,6}(\r\n [\n\r\t\f])?</code>
escape	<code>{unicode} \\[^\n\r\f0-9a-f]</code>
nmchar	<code>[_a-z0-9-] {nonascii} {escape}</code>
num	<code>[0-9]+ [0-9]*\.[0-9]+</code>
string	<code>{string1} {string2}</code>
string1	<code>"([\n\r\f\\"] \\{nl} {escape})*\"</code>
string2	<code>'([\n\r\f\\'] \\{nl} {escape})*\'</code>
badstring	<code>{badstring1} {badstring2}</code>
badstring1	<code>"([\n\r\f\\"] \\{nl} {escape})*\\?</code>
badstring2	<code>'([\n\r\f\\'] \\{nl} {escape})*\\?</code>
badcomment	<code>{badcomment1} {badcomment2}</code>
badcomment1	<code>\/*[\^]***(\[\/*\][\^]***)*</code>
badcomment2	<code>\/*[\^]**(*[\/*\][\^]**)*</code>
baduri	<code>{baduri1} {baduri2} {baduri3}</code>
baduri1	<code>url\({w}([!#\$%&*~] {nonascii} {escape})*{w}</code>
baduri2	<code>url\({w}{string}{w}</code>
baduri3	<code>url\({w}{badstring}</code>
nl	<code>\n \r\n \r \f</code>
w	<code>[\t\r\n\f]*</code>

Below is the core syntax for CSS. The sections that follow describe how to use it. Appendix G [p. 449] describes a more restrictive grammar that is closer to the CSS level 2 language. Parts of style sheets that can be parsed according to this grammar

but not according to the grammar in Appendix G are among the parts that will be ignored according to the rules for handling parsing errors [p. 60] .

```

stylesheet : [ CDO | CDC | S | statement ]*;
statement  : ruleset | at-rule;
at-rule    : ATKEYWORD S* any* [ block | ';' S* ];
block      : '{' S* [ any | block | ATKEYWORD S* | ';' S* ]* '}' S*;
ruleset    : selector? '{' S* declaration? [ ';' S* declaration? ]* '}' S*;
selector   : any+;
declaration: property S* ':' S* value;
property   : IDENT;
value      : [ any | block | ATKEYWORD S* ]+;
any        : [ IDENT | NUMBER | PERCENTAGE | DIMENSION | STRING
              | DELIM | URI | HASH | UNICODE-RANGE | INCLUDES
              | DASHMATCH | ':' | FUNCTION S* [any|unused]* ')'
              | '(' S* [any|unused]* ')' | '[' S* [any|unused]* ']'
            ] S*;
unused     : block | ATKEYWORD S* | ';' S* | CDO S* | CDC S*;

```

The "unused" production is not used in CSS and will not be used by any future extension. It is included here only to help with error handling. (See 4.2 "Rules for handling parsing errors." [p. 60])

COMMENT tokens do not occur in the grammar (to keep it readable), but any number of these tokens may appear anywhere outside other tokens. (Note, however, that a comment before or within the @charset rule disables the @charset.)

The token S in the grammar above stands for white space. Only the characters "space" (U+0020), "tab" (U+0009), "line feed" (U+000A), "carriage return" (U+000D), and "form feed" (U+000C) can occur in white space. Other space-like characters, such as "em-space" (U+2003) and "ideographic space" (U+3000), are never part of white space.

The meaning of input that cannot be tokenized or parsed is undefined in CSS 2.1.

4.1.2 Keywords

Keywords have the form of identifiers. [p. 55] Keywords must not be placed between quotes ("..." or '...'). Thus,

```
red
```

is a keyword, but

```
"red"
```

is not. (It is a string [p. 70] .) Other illegal examples:

Illegal example(s):

```
width: "auto";
border: "none";
background: "red";
```

4.1.2.1 Vendor-specific extensions

In CSS, identifiers may begin with '-' (dash) or '_' (underscore). Keywords and property names [p. 59] beginning with '-' or '_' are reserved for vendor-specific extensions. Such vendor-specific extensions should have one of the following formats:

```
'-' + vendor identifier + '-' + meaningful name  
'_' + vendor identifier + '-' + meaningful name
```

Example(s):

For example, if XYZ organization added a property to describe the color of the border on the East side of the display, they might call it `-xyz-border-east-color`.

Other known examples:

```
-moz-box-sizing  
-moz-border-radius  
-wap-accesskey
```

An initial dash or underscore is guaranteed never to be used in a property or keyword by any current or future level of CSS. Thus typical CSS implementations may not recognize such properties and may ignore them according to the rules for handling parsing errors [p. 60]. However, because the initial dash or underscore is part of the grammar, CSS 2.1 implementers should always be able to use a CSS-conforming parser, whether or not they support any vendor-specific extensions.

Authors should avoid vendor-specific extensions

4.1.2.2 Informative Historical Notes

This section is informative.

At the time of writing, the following prefixes are known to exist:

prefix	organization
-ms-, mso-	Microsoft
-moz-	Mozilla
-o-, -xv-	Opera Software
-atsc-	Advanced Television Standards Committee
-wap-	The WAP Forum
-khtml-	KDE
-webkit-	Apple
prince-	YesLogic
-ah-	Antenna House
-hp-	Hewlett Packard
-ro-	Real Objects
-rim-	Research In Motion
-tc-	Tall Components

4.1.3 Characters and case

The following rules always hold:

- All CSS syntax is case-insensitive within the ASCII range (i.e., [a-z] and [A-Z] are equivalent), except for parts that are not under the control of CSS. For example, the case-sensitivity of values of the HTML attributes "id" and "class", of font names, and of URIs lies outside the scope of this specification. Note in particular that element names are case-insensitive in HTML, but case-sensitive in XML.
- In CSS, *identifiers* (including element names, classes, and IDs in selectors [p. 77]) can contain only the characters [a-zA-Z0-9] and ISO 10646 characters U+00A0 and higher, plus the hyphen (-) and the underscore (_); they cannot start with a digit, two hyphens, or a hyphen followed by a digit. Identifiers can also contain escaped characters and any ISO 10646 character as a numeric code (see next item). For instance, the identifier "B&W?" may be written as "B&W\?" or "B\26 W\3F".

Note that Unicode is code-by-code equivalent to ISO 10646 (see [UNICODE] and [ISO10646]).

- In CSS 2.1, a backslash (\) character can indicate one of three types of character escape. Inside a CSS comment, a backslash stands for itself, and if a backslash is immediately followed by the end of the style sheet, it also stands for

itself (i.e., a DELIM token).

First, inside a string [p. 70] , a backslash followed by a newline is ignored (i.e., the string is deemed not to contain either the backslash or the newline). Outside a string, a backslash followed by a newline stands for itself (i.e., a DELIM followed by a newline).

Second, it cancels the meaning of special CSS characters. Any character (except a hexadecimal digit, linefeed, carriage return, or form feed) can be escaped with a backslash to remove its special meaning. For example, "\" is a string consisting of one double quote. Style sheet preprocessors must not remove these backslashes from a style sheet since that would change the style sheet's meaning.

Third, backslash escapes allow authors to refer to characters they cannot easily put in a document. In this case, the backslash is followed by at most six hexadecimal digits (0..9A..F), which stand for the ISO 10646 ([ISO10646]) character with that number, which must not be zero. (It is undefined in CSS 2.1 what happens if a style sheet *does* contain a character with Unicode codepoint zero.) If a character in the range [0-9a-fA-F] follows the hexadecimal number, the end of the number needs to be made clear. There are two ways to do that:

1. with a space (or other white space character): "\26 B" ("&B"). In this case, user agents should treat a "CR/LF" pair (U+000D/U+000A) as a single white space character.
2. by providing exactly 6 hexadecimal digits: "\000026B" ("&B")

In fact, these two methods may be combined. Only one white space character is ignored after a hexadecimal escape. Note that this means that a "real" space after the escape sequence must be doubled.

If the number is outside the range allowed by Unicode (e.g., "\110000" is above the maximum 10FFFF allowed in current Unicode), the UA may replace the escape with the "replacement character" (U+FFFD). If the character is to be displayed, the UA should show a visible symbol, such as a "missing character" glyph (cf. 15.2, [p. 241] point 5).

- Note: Backslash escapes are always considered to be part of an identifier [p. 55] or a string (i.e., "\7B" is not punctuation, even though "{" is, and "\32" is allowed at the start of a class name, even though "2" is not).

The identifier "te\st" is exactly the same identifier as "test".

4.1.4 Statements

A CSS style sheet, for any level of CSS, consists of a list of *statements* (see the grammar [p. 50] above). There are two kinds of statements: *at-rules* and *rule sets*. There may be white space [p. 53] around the statements.

4.1.5 At-rules

At-rules start with an *at-keyword*, an '@' character followed immediately by an identifier [p. 55] (for example, '@import', '@page').

An at-rule consists of everything up to and including the next semicolon (;) or the next block, [p. 57] whichever comes first.

CSS 2.1 user agents must ignore [p. 60] any '@import' [p. 102] rule that occurs inside a block [p. 57] or after any non-ignored statement other than an @charset or an @import rule.

Illegal example(s):

Assume, for example, that a CSS 2.1 parser encounters this style sheet:

```
@import "subs.css";
h1 { color: blue }
@import "list.css";
```

The second '@import' is illegal according to CSS 2.1. The CSS 2.1 parser ignores [p. 60] the whole at-rule, effectively reducing the style sheet to:

```
@import "subs.css";
h1 { color: blue }
```

Illegal example(s):

In the following example, the second '@import' rule is invalid, since it occurs inside a '@media' block [p. 57] .

```
@import "subs.css";
@media print {
  @import "print-main.css";
  body { font-size: 10pt }
}
h1 {color: blue }
```

Instead, to achieve the effect of only importing a style sheet for 'print' media, use the @import rule with media syntax, e.g.:

```
@import "subs.css";
@import "print-main.css" print;
@media print {
  body { font-size: 10pt }
}
h1 {color: blue }
```

4.1.6 Blocks

A *block* starts with a left curly brace ({) and ends with the matching right curly brace (}). In between there may be any tokens, except that parentheses (()), brackets ([]), and braces ({ }) must always occur in matching pairs and may be nested. Single (') and double quotes (") must also occur in matching pairs, and characters between them are parsed as a string. See Tokenization [p. 50] above for the definition of a

string.

Illegal example(s):

Here is an example of a block. Note that the right brace between the double quotes does not match the opening brace of the block, and that the second single quote is an escaped character [p. 55] , and thus does not match the first single quote:

```
{ causta: "}" + ( {7} * '\'' ) }
```

Note that the above rule is not valid CSS 2.1, but it is still a block as defined above.

4.1.7 Rule sets, declaration blocks, and selectors

A rule set (also called "rule") consists of a selector followed by a declaration block.

A *declaration block* starts with a left curly brace ({) and ends with the matching right curly brace (}). In between there must be a list of zero or more semicolon-separated (;) declarations.

The *selector* (see also the section on selectors [p. 77]) consists of everything up to (but not including) the first left curly brace ({). A selector always goes together with a declaration block. When a user agent cannot parse the selector (i.e., it is not valid CSS 2.1), it must ignore [p. 60] the selector and the following declaration block (if any) as well.

CSS 2.1 gives a special meaning to the comma (,) in selectors. However, since it is not known if the comma may acquire other meanings in future updates of CSS, the whole statement should be ignored [p. 60] if there is an error anywhere in the selector, even though the rest of the selector may look reasonable in CSS 2.1.

Illegal example(s):

For example, since the "&" is not a valid token in a CSS 2.1 selector, a CSS 2.1 user agent must ignore [p. 60] the whole second line, and not set the color of H3 to red:

```
h1, h2 {color: green }
h3, h4 & h5 {color: red }
h6 {color: black }
```

Example(s):

Here is a more complex example. The first two pairs of curly braces are inside a string, and do not mark the end of the selector. This is a valid CSS 2.1 rule.

```
p[example="public class foo\
{\
  private int x;\
\
  foo(int x) {\
    this.x = x;\
  }\
\
}"] { color: red }
```

4.1.8 Declarations and properties

A *declaration* is either empty or consists of a property name, followed by a colon (:), followed by a property value. Around each of these there may be white space [p. 53]

Because of the way selectors work, multiple declarations for the same selector may be organized into semicolon (;) separated groups.

Example(s):

Thus, the following rules:

```
h1 { font-weight: bold }
h1 { font-size: 12px }
h1 { line-height: 14px }
h1 { font-family: Helvetica }
h1 { font-variant: normal }
h1 { font-style: normal }
```

are equivalent to:

```
h1 {
  font-weight: bold;
  font-size: 12px;
  line-height: 14px;
  font-family: Helvetica;
  font-variant: normal;
  font-style: normal
}
```

A property name is an identifier [p. 55]. Any token may occur in the property value. Parentheses ("()"), brackets ("[]"), braces ("{}"), single quotes (''), and double quotes ("") must come in matching pairs, and semicolons not in strings must be escaped [p. 55]. Parentheses, brackets, and braces may be nested. Inside the quotes, characters are parsed as a string.

The syntax of values is specified separately for each property, but in any case, values are built from identifiers, strings, numbers, lengths, percentages, URIs, colors, etc.

A user agent must ignore [p. 60] a declaration with an invalid property name or an invalid value. Every CSS property has its own syntactic and semantic restrictions on the values it accepts.

Illegal example(s):

For example, assume a CSS 2.1 parser encounters this style sheet:

```
h1 { color: red; font-style: 12pt } /* Invalid value: 12pt */
p { color: blue; font-vendor: any; /* Invalid prop.: font-vendor */
  font-variant: small-caps }
em em { font-style: normal }
```

The second declaration on the first line has an invalid value '12pt'. The second declaration on the second line contains an undefined property 'font-vendor'. The CSS 2.1 parser will ignore [p. 60] these declarations, effectively reducing the style sheet to:

```
h1 { color: red; }
p { color: blue; font-variant: small-caps }
em em { font-style: normal }
```

4.1.9 Comments

Comments begin with the characters `/*` and end with the characters `*/`. They may occur anywhere between tokens, and their contents have no influence on the rendering. Comments may not be nested.

CSS also allows the SGML comment delimiters (`<!--` and `-->`) in certain places defined by the grammar, but they do not delimit CSS comments. They are permitted so that style rules appearing in an HTML source document (in the `STYLE` element) may be hidden from pre-HTML 3.2 user agents. See the HTML 4 specification ([HTML4]) for more information.

4.2 Rules for handling parsing errors

In some cases, user agents must ignore part of an illegal style sheet. This specification defines *ignore* to mean that the user agent parses the illegal part (in order to find its beginning and end), but otherwise acts as if it had not been there. CSS 2.1 reserves for future updates of CSS all property:value combinations and `@`-keywords that do not contain an identifier beginning with dash or underscore. Implementations must ignore such combinations (other than those introduced by future updates of CSS).

To ensure that new properties and new values for existing properties can be added in the future, user agents are required to obey the following rules when they encounter the following scenarios:

- **Unknown properties.** User agents must ignore [p. 60] a declaration [p. 59] with an unknown property. For example, if the style sheet is:

```
h1 { color: red; rotation: 70minutes }
```

the user agent will treat this as if the style sheet had been

```
h1 { color: red }
```

- **Illegal values.** User agents must ignore a declaration with an illegal value. For example:

```
img { float: left } /* correct CSS 2.1 */
img { float: left here } /* "here" is not a value of 'float' */
img { background: "red" } /* keywords cannot be quoted */
img { border-width: 3 } /* a unit must be specified for length values */
```

A CSS 2.1 parser would honor the first rule and ignore [p. 60] the rest, as if the style sheet had been:

```
img { float: left }
img { }
img { }
img { }
```

A user agent conforming to a future CSS specification may accept one or more of the other rules as well.

- **Malformed declarations.** User agents must handle unexpected tokens encountered while parsing a declaration by reading until the end of the declaration, while observing the rules for matching pairs of (), [], {}, "", and ", and correctly handling escapes. For example, a malformed declaration may be missing a property name, colon (:), or property value. The following are all equivalent:

```
p { color:green }
p { color:green; color } /* malformed declaration missing ':', value */
p { color:red; color; color:green } /* same with expected recovery */
p { color:green; color: } /* malformed declaration missing value */
p { color:red; color; color:green } /* same with expected recovery */
p { color:green; color{;color:maroon} } /* unexpected tokens { } */
p { color:red; color{;color:maroon}; color:green } /* same with recovery */
```

- **Malformed statements.** User agents must handle unexpected tokens encountered while parsing a statement by reading until the end of the statement, while observing the rules for matching pairs of (), [], {}, "", and ", and correctly handling escapes. For example, a malformed statement may contain an unexpected closing brace or at-keyword. E.g., the following lines are all ignored:

```
p @here {color: red} /* ruleset with unexpected at-keyword "@here" */
@foo @bar; /* at-rule with unexpected at-keyword "@bar" */
}} {{ - }} /* ruleset with unexpected right brace */
) ( { } ) p {color: red } /* ruleset with unexpected right parenthesis */
```

- **At-rules with unknown at-keywords.** User agents must ignore [p. 60] an invalid at-keyword together with everything following it, up to the end of the block that contains the invalid at-keyword, or up to and including the next semicolon (;), or up to and including the next block ({...}), whichever comes first. For example, consider the following:

```
@three-dee {
  @background-lighting {
    azimuth: 30deg;
    elevation: 190deg;
  }
  h1 { color: red }
}
h1 { color: blue }
```

The '@three-dee' at-rule is not part of CSS 2.1. Therefore, the whole at-rule (up to, and including, the third right curly brace) is ignored. [p. 60] A CSS 2.1 user agent ignores [p. 60] it, effectively reducing the style sheet to:

```
h1 { color: blue }
```

Something inside an at-rule that is ignored because it is invalid, such as an invalid declaration within an @media-rule, does not make the entire at-rule invalid.

- **Unexpected end of style sheet.**

User agents must close all open constructs (for example: blocks, parentheses, brackets, rules, strings, and comments) at the end of the style sheet. For example:

```
@media screen {
  p:before { content: 'Hello
```

would be treated the same as:

```
@media screen {
  p:before { content: 'Hello'; }
}
```

in a conformant UA.

- **Unexpected end of string.**

User agents must close strings upon reaching the end of a line, but then drop the construct (declaration or rule) in which the string was found. For example:

```
p {
  color: green;
  font-family: 'Courier New Times
  color: red;
  color: green;
}
```

...would be treated the same as:

```
p { color: green; color: green; }
```

...because the second declaration (from 'font-family' to the semicolon after 'color: red') is invalid and is dropped.

- See also Rule sets, declaration blocks, and selectors [p. 58] for parsing rules for declaration blocks.

4.3 Values

4.3.1 Integers and real numbers

Some value types may have integer values (denoted by <integer>) or real number values (denoted by <number>). Real numbers and integers are specified in decimal notation only. An <integer> consists of one or more digits "0" to "9". A <number> can either be an <integer>, or it can be zero or more digits followed by a dot (.) followed by one or more digits. Both integers and real numbers may be preceded by a "-" or "+" to indicate the sign. -0 is equivalent to 0 and is not a negative number.

Note that many properties that allow an integer or real number as a value actually restrict the value to some range, often to a non-negative value.

4.3.2 Lengths

Lengths refer to distance measurements.

The format of a length value (denoted by <length> in this specification) is a <number> (with or without a decimal point) immediately followed by a unit identifier (e.g., px, em, etc.). After a zero length, the unit identifier is optional.

Some properties allow negative length values, but this may complicate the formatting model and there may be implementation-specific limits. If a negative length value cannot be supported, it should be converted to the nearest value that can be supported.

If a negative length value is set on a property that does not allow negative length values, the declaration is ignored.

In cases where the used [p. 100] length cannot be supported, user agents must approximate it in the actual value. [p. 100]

There are two types of length units: relative and absolute. *Relative length* units specify a length relative to another length property. Style sheets that use relative units can more easily scale from one output environment to another.

Relative units are:

- **em**: the 'font-size' of the relevant font
- **ex**: the 'x-height' of the relevant font
-

Example(s):

```
h1 { margin: 0.5em }      /* em */
h1 { margin: 1ex }      /* ex */
```

The 'em' unit is equal to the computed value of the 'font-size' property of the element on which it is used. The exception is when 'em' occurs in the value of the 'font-size' property itself, in which case it refers to the font size of the parent element. It may be used for vertical or horizontal measurement. (This unit is also sometimes

called the quad-width in typographic texts.)

The 'ex' unit is defined by the element's first available font. The exception is when 'ex' occurs in the value of the 'font-size' property, in which case it refers to the 'ex' of the parent element.

The 'x-height' is so called because it is often equal to the height of the lowercase "x". However, an 'ex' is defined even for fonts that do not contain an "x".

The x-height of a font can be found in different ways. Some fonts contain reliable metrics for the x-height. If reliable font metrics are not available, UAs may determine the x-height from the height of a lowercase glyph. One possible heuristic is to look at how far the glyph for the lowercase "o" extends below the baseline, and subtract that value from the top of its bounding box. In the cases where it is impossible or impractical to determine the x-height, a value of 0.5em should be used.

Example(s):

The rule:

```
h1 { line-height: 1.2em }
```

means that the line height of "h1" elements will be 20% greater than the font size of the "h1" elements. On the other hand:

```
h1 { font-size: 1.2em }
```

means that the font-size of "h1" elements will be 20% greater than the font size inherited by "h1" elements.

When specified for the root of the document tree [p. 45] (e.g., "HTML" in HTML), 'em' and 'ex' refer to the property's initial value [p. 31] .

Child elements do not inherit the relative values specified for their parent; they inherit the computed values [p. 100] .

Example(s):

In the following rules, the computed 'text-indent' value of "h1" elements will be 36px, not 45px, if "h1" is a child of the "body" element.

```
body {
  font-size: 12px;
  text-indent: 3em; /* i.e., 36px */
}
h1 { font-size: 15px }
```

Absolute length units are fixed in relation to each other. They are mainly useful when the output environment is known. The absolute units consist of the physical units (in, cm, mm, pt, pc) and the px unit:

- **in**: inches — 1in is equal to 2.54cm.
- **cm**: centimeters
- **mm**: millimeters
- **pt**: points — the points used by CSS are equal to 1/72nd of 1in.

- **pc**: picas — 1pc is equal to 12pt.
- **px**: pixel units — 1px is equal to 0.75pt.

For a CSS device, these dimensions are either anchored (i) by relating the physical units to their physical measurements, or (ii) by relating the pixel unit to the *reference pixel*. For print media and similar high-resolution devices, the anchor unit should be one of the standard physical units (inches, centimeters, etc). For lower-resolution devices, and devices with unusual viewing distances, it is recommended instead that the anchor unit be the pixel unit. For such devices it is recommended that the pixel unit refer to the whole number of device pixels that best approximates the reference pixel.

Note that if the anchor unit is the pixel unit, the physical units might not match their physical measurements. Alternatively if the anchor unit is a physical unit, the pixel unit might not map to a whole number of device pixels.

Note that this definition of the pixel unit and the physical units differs from previous versions of CSS. In particular, in previous versions of CSS the pixel unit and the physical units were not related by a fixed ratio: the physical units were always tied to their physical measurements while the pixel unit would vary to most closely match the reference pixel. (This change was made because too much existing content relies on the assumption of 96dpi, and breaking that assumption breaks the content.)

The *reference pixel* is the visual angle of one pixel on a device with a pixel density of 96dpi and a distance from the reader of an arm's length. For a nominal arm's length of 28 inches, the visual angle is therefore about 0.0213 degrees. For reading at arm's length, 1px thus corresponds to about 0.26 mm (1/96 inch).

The image below illustrates the effect of viewing distance on the size of a reference pixel: a reading distance of 71 cm (28 inches) results in a reference pixel of 0.26 mm, while a reading distance of 3.5 m (12 feet) results in a reference pixel of 1.3 mm.

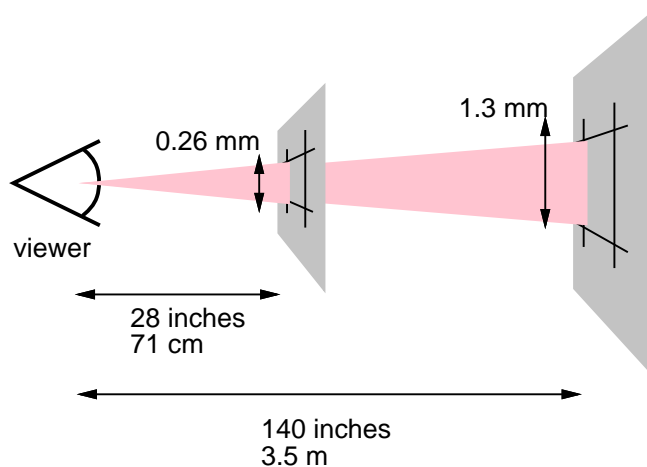

This second image illustrates the effect of a device's resolution on the pixel unit: an area of 1px by 1px is covered by a single dot in a low-resolution device (e.g. a typical computer display), while the same area is covered by 16 dots in a higher resolution device (such as a printer).

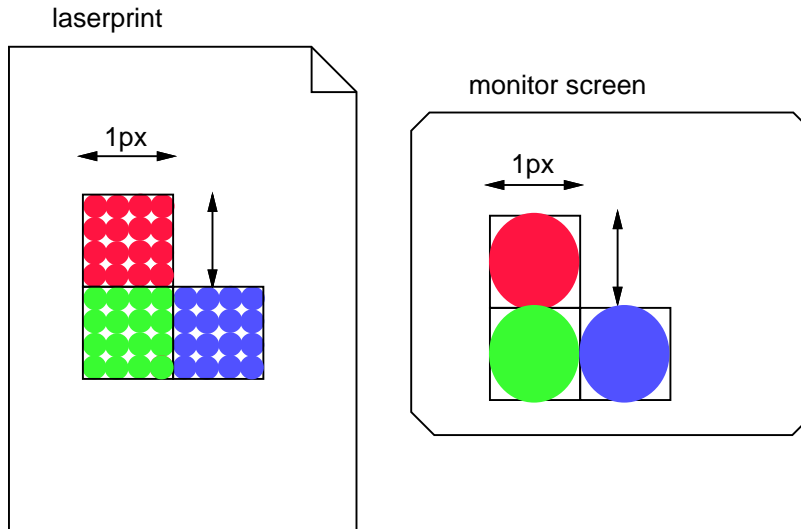

 = 1 device pixel

Example(s):

```
h1 { margin: 0.5in }      /* inches */
h2 { line-height: 3cm } /* centimeters */
h3 { word-spacing: 4mm } /* millimeters */
h4 { font-size: 12pt }  /* points */
h4 { font-size: 1pc }   /* picas */
p  { font-size: 12px }  /* px */
```

4.3.3 Percentages

The format of a percentage value (denoted by <percentage> in this specification) is a <number> immediately followed by '%'.

Percentage values are always relative to another value, for example a length. Each property that allows percentages also defines the value to which the percentage refers. The value may be that of another property for the same element, a property for an ancestor element, or a value of the formatting context (e.g., the width of a containing block [p. 128]). When a percentage value is set for a property of the root [p. 45] element and the percentage is defined as referring to the inherited value of some property, the resultant value is the percentage times the initial value [p. 31] of that property.

Example(s):

Since child elements (generally) inherit the computed values [p. 100] of their parent, in the following example, the children of the P element will inherit a value of 12px for 'line-height', not the percentage value (120%):

```
p { font-size: 10px }
p { line-height: 120% } /* 120% of 'font-size' */
```

4.3.4 URLs and URIs

URI values (Uniform Resource Identifiers, see [RFC3986], which includes URLs, URNs, etc) in this specification are denoted by <uri>. The functional notation used to designate URIs in property values is "url()", as in:

Example(s):

```
body { background: url("http://www.example.com/pinkish.png") }
```

The format of a URI value is 'url(' followed by optional white space [p. 53] followed by an optional single quote (') or double quote (") character followed by the URI itself, followed by an optional single quote (') or double quote (") character followed by optional white space followed by ')'. The two quote characters must be the same.

Example(s):

An example without quotes:

```
li { list-style: url(http://www.example.com/redball.png) disc }
```

Some characters appearing in an unquoted URI, such as parentheses, white space characters, single quotes (') and double quotes ("), must be escaped with a backslash so that the resulting URI value is a URI token: '\(, \)'.

Depending on the type of URI, it might also be possible to write the above characters as URI-escapes (where "(" = %28, ")" = %29, etc.) as described in [RFC3986].

Note. *Since URIs may contain characters that would otherwise be used as delimiters in CSS, the entire URI value must be treated as a single unit by the tokenizer and normal tokenization behavior does not apply within a URI value. Therefore comments are not allowed within a URI value.*

In order to create modular style sheets that are not dependent on the absolute location of a resource, authors may use relative URIs. Relative URIs (as defined in [RFC3986]) are resolved to full URIs using a base URI. RFC 3986, section 5, defines the normative algorithm for this process. For CSS style sheets, the base URI is that of the style sheet, not that of the source document.

Example(s):

For example, suppose the following rule:

```
body { background: url("yellow") }
```

is located in a style sheet designated by the URI:

```
http://www.example.org/style/basic.css
```

The background of the source document's BODY will be tiled with whatever image is described by the resource designated by the URI

```
http://www.example.org/style/yellow
```

User agents may vary in how they handle invalid URIs or URIs that designate unavailable or inapplicable resources.

4.3.5 Counters

Counters are denoted by case-sensitive identifiers (see the 'counter-increment' and 'counter-reset' properties). To refer to the value of a counter, the notation 'counter(<identifier>)' or 'counter(<identifier>, <'list-style-type'>)', with optional white space separating the tokens, is used. The default style is 'decimal'.

To refer to a sequence of nested counters of the same name, the notation is 'counters(<identifier>, <string>)' or 'counters(<identifier>, <string>, <'list-style-type'>)' with optional white space separating the tokens.

See "Nested counters and scope" [p. 212] in the chapter on generated content [p. 203] for how user agents must determine the value or values of the counter. See the definition of counter values of the 'content' property for how it must convert these values to a string.

In CSS 2.1, the values of counters can only be referred to from the 'content' property. Note that 'none' is a possible <'list-style-type'>: 'counter(x, none)' yields an empty string.

Example(s):

Here is a style sheet that numbers paragraphs (p) for each chapter (h1). The paragraphs are numbered with roman numerals, followed by a period and a space:

```
p {counter-increment: par-num}
h1 {counter-reset: par-num}
p:before {content: counter(par-num, upper-roman) ". "}
```

4.3.6 Colors

A <color> is either a keyword or a numerical RGB specification.

The list of color keywords is: aqua, black, blue, fuchsia, gray, green, lime, maroon, navy, olive, orange, purple, red, silver, teal, white, and yellow. These 17 colors have the following values:

```
maroon #800000 red #ff0000 orange #ffa500 yellow #ffff00 olive #808000
purple #800080 fuchsia #ff00ff white #ffffff lime #00ff00 green #008000
navy #000080 blue #0000ff aqua #00ffff teal #008080
black #000000 silver #c0c0c0 gray #808080
```

In addition to these color keywords, users may specify keywords that correspond to the colors used by certain objects in the user's environment. Please consult the section on system colors [p. 298] for more information.

Example(s):

```
body {color: black; background: white }
h1 { color: maroon }
h2 { color: olive }
```

The RGB color model is used in numerical color specifications. These examples all specify the same color:

Example(s):

```
em { color: #f00 }           /* #rgb */
em { color: #ff0000 }       /* #rrggbb */
em { color: rgb(255,0,0) }
em { color: rgb(100%, 0%, 0%) }
```

The format of an RGB value in hexadecimal notation is a '#' immediately followed by either three or six hexadecimal characters. The three-digit RGB notation (`#rgb`) is converted into six-digit form (`#rrggbb`) by replicating digits, not by adding zeros. For example, `#fb0` expands to `#ffbb00`. This ensures that white (`#ffffff`) can be specified with the short notation (`#fff`) and removes any dependencies on the color depth of the display.

The format of an RGB value in the functional notation is 'rgb(' followed by a comma-separated list of three numerical values (either three integer values or three percentage values) followed by ')'. The integer value 255 corresponds to 100%, and to F or FF in the hexadecimal notation: `rgb(255,255,255) = rgb(100%,100%,100%) = #FFF`. White space [p. 53] characters are allowed around the numerical values.

All RGB colors are specified in the sRGB color space (see [SRGB]). User agents may vary in the fidelity with which they represent these colors, but using sRGB provides an unambiguous and objectively measurable definition of what the color should be, which can be related to international standards (see [COLORIMETRY]).

Conforming user agents [p. 47] may limit their color-displaying efforts to performing a gamma-correction on them. sRGB specifies a display gamma of 2.2 under specified viewing conditions. User agents should adjust the colors given in CSS such that, in combination with an output device's "natural" display gamma, an effective display gamma of 2.2 is produced. See the section on gamma correction [p. 238] for further details. Note that only colors specified in CSS are affected; e.g., images are expected to carry their own color information.

Values outside the device gamut should be clipped or mapped into the gamut when the gamut is known: the red, green, and blue values must be changed to fall within the range supported by the device. User agents may perform higher quality mapping of colors from one gamut to another. For a typical CRT monitor, whose device gamut is the same as sRGB, the four rules below are equivalent:

Example(s):

```
em { color: rgb(255,0,0) }      /* integer range 0 - 255 */
em { color: rgb(300,0,0) }      /* clipped to rgb(255,0,0) */
em { color: rgb(255,-10,0) }     /* clipped to rgb(255,0,0) */
em { color: rgb(110%, 0%, 0%) } /* clipped to rgb(100%,0%,0%) */
```

Other devices, such as printers, have different gamuts than sRGB; some colors outside the 0..255 sRGB range will be representable (inside the device gamut), while other colors inside the 0..255 sRGB range will be outside the device gamut and will thus be mapped.

Note. *Mapping or clipping of color values should be done to the actual device gamut if known (which may be larger or smaller than 0..255).*

4.3.7 Strings

Strings can either be written with double quotes or with single quotes. Double quotes cannot occur inside double quotes, unless escaped (e.g., as `\` or as `\22'`). Analogously for single quotes (e.g., `\` or `\27"`).

Example(s):

```
"this is a 'string'"
"this is a \"string\""
'this is a "string"'
'this is a \'string\''
```

A string cannot directly contain a newline. To include a newline in a string, use an escape representing the line feed character in ISO-10646 (U+000A), such as `\A` or `\00000a`. This character represents the generic notion of "newline" in CSS. See the `'content'` property for an example.

It is possible to break strings over several lines, for aesthetic or other reasons, but in such a case the newline itself has to be escaped with a backslash (`\`). For instance, the following two selectors are exactly the same:

Example(s):

```
a[title="a not s\
o very long title"] { /*...*/}
a[title="a not so very long title"] { /*...*/}
```

4.3.8 Unsupported Values

If a UA does not support a particular value, it should *ignore* that value when parsing style sheets, as if that value was an illegal value [p. 61] . For example:

Example(s):

```
h3 {
  display: inline;
  display: run-in;
}
```

A UA that supports the 'run-in' value for the 'display' property will accept the first display declaration and then "write over" that value with the second display declaration. A UA that does not support the 'run-in' value will process the first display declaration and ignore the second display declaration.

4.4 CSS style sheet representation

A CSS style sheet is a sequence of characters from the Universal Character Set (see [ISO10646]). For transmission and storage, these characters must be encoded by a character encoding that supports the set of characters available in US-ASCII (e.g., UTF-8, ISO 8859-x, SHIFT JIS, etc.). For a good introduction to character sets and character encodings, please consult the HTML 4 specification ([HTML4], chapter 5). See also the XML 1.0 specification ([XML10], sections 2.2 and 4.3.3, and Appendix F).

When a style sheet is embedded in another document, such as in the STYLE element or "style" attribute of HTML, the style sheet shares the character encoding of the whole document.

When a style sheet resides in a separate file, user agents must observe the following priorities when determining a style sheet's character encoding (from highest priority to lowest):

1. An HTTP "charset" parameter in a "Content-Type" field (or similar parameters in other protocols)
2. BOM and/or @charset (see below)
3. <link charset=" "> or other metadata from the linking mechanism (if any)
4. charset of referring style sheet or document (if any)
5. Assume UTF-8

Authors using an @charset rule must place the rule at the very beginning of the style sheet, preceded by no characters. (If a byte order mark is appropriate for the encoding used, it may precede the @charset rule.)

After "@charset", authors specify the name of a character encoding (in quotes). For example:

```
@charset "ISO-8859-1";
```

@charset must be written literally, i.e., the 10 characters '@charset "' (lowercase, no backslash escapes), followed by the encoding name, followed by '";'.

The name must be a charset name as described in the IANA registry. See [CHARSETS] for a complete list of charsets. Authors should use the charset names marked as "preferred MIME name" in the IANA registry.

User agents must support at least the UTF-8 encoding.

User agents must ignore any @charset rule not at the beginning of the style sheet. When user agents detect the character encoding using the BOM and/or the @charset rule, they should follow the following rules:

- Except as specified in these rules, all @charset rules are ignored.
- The encoding is detected based on the stream of bytes that begins the style sheet. The following table gives a set of possibilities for initial byte sequences (written in hexadecimal). The first row that matches the beginning of the style sheet gives the result of encoding detection based on the BOM and/or @charset rule. If no rows match, the encoding cannot be detected based on the BOM and/or @charset rule. The notation (...) * refers to repetition for which the best match is the one that repeats as few times as possible. The bytes marked "XX" are those used to determine the name of the encoding, by treating them, in the order given, as a sequence of ASCII characters. Bytes marked "YY" are similar, but need to be transcoded into ASCII as noted. User agents may ignore entries in the table if they do not support any encodings relevant to the entry.

Initial Bytes	Result
EF BB BF 40 63 68 61 72 73 65 74 20 22 (XX)* 22 3B	as specified
EF BB BF	UTF-8
40 63 68 61 72 73 65 74 20 22 (XX)* 22 3B	as specified
FE FF 00 40 00 63 00 68 00 61 00 72 00 73 00 65 00 74 00 20 00 22 (00 XX)* 00 22 00 3B	as specified (with BE endianness if not specified)
00 40 00 63 00 68 00 61 00 72 00 73 00 65 00 74 00 20 00 22 (00 XX)* 00 22 00 3B	as specified (with BE endianness if not specified)
FF FE 40 00 63 00 68 00 61 00 72 00 73 00 65 00 74 00 20 00 22 00 (XX 00)* 22 00 3B 00	as specified (with LE endianness if not specified)
40 00 63 00 68 00 61 00 72 00 73 00 65 00 74 00 20 00 22 00 (XX 00)* 22 00 3B 00	as specified (with LE endianness if not specified)
00 00 FE FF 00 00 00 40 00 00 00 63 00 00 00 68 00 00 00 61 00 00 00 72 00 00 00 73 00 00 00 65 00 00 00 74 00 00 00 20 00 00 00 22 (00 00 00 XX)* 00 00 00 22 00 00 00 3B	as specified (with BE endianness if not specified)

00 00 00 40 00 00 00 63 00 00 00 68 00 00 00 61 00 00 00 72 00 00 00 73 00 00 00 65 00 00 00 74 00 00 00 20 00 00 00 22 (00 00 00 XX)* 00 00 00 22 00 00 00 3B	as specified (with BE endianness if not specified)
00 00 FF FE 00 00 40 00 00 00 63 00 00 00 68 00 00 00 61 00 00 00 72 00 00 00 73 00 00 00 65 00 00 00 74 00 00 00 20 00 00 00 22 00 (00 00 XX 00)* 00 00 22 00 00 00 3B 00	as specified (with 2143 endian- ness if not specified)
00 00 40 00 00 00 63 00 00 00 68 00 00 00 61 00 00 00 72 00 00 00 73 00 00 00 65 00 00 00 74 00 00 00 20 00 00 00 22 00 (00 00 XX 00)* 00 00 22 00 00 00 3B 00	as specified (with 2143 endian- ness if not specified)
FE FF 00 00 00 40 00 00 00 63 00 00 00 68 00 00 00 61 00 00 00 72 00 00 00 73 00 00 00 65 00 00 00 74 00 00 00 20 00 00 00 22 00 00 (00 XX 00 00)* 00 22 00 00 00 3B 00 00	as specified (with 3412 endian- ness if not specified)
00 40 00 00 00 63 00 00 00 68 00 00 00 61 00 00 00 72 00 00 00 73 00 00 00 65 00 00 00 74 00 00 00 20 00 00 00 22 00 00 (00 XX 00 00)* 00 22 00 00 00 3B 00 00	as specified (with 3412 endian- ness if not specified)
FF FE 00 00 40 00 00 00 63 00 00 00 68 00 00 00 61 00 00 00 72 00 00 00 73 00 00 00 65 00 00 00 74 00 00 00 20 00 00 00 22 00 00 00 (XX 00 00 00)* 22 00 00 00 3B 00 00 00	as specified (with LE endianness if not specified)
40 00 00 00 63 00 00 00 68 00 00 00 61 00 00 00 72 00 00 00 73 00 00 00 65 00 00 00 74 00 00 00 20 00 00 00 22 00 00 00 (XX 00 00 00)* 22 00 00 00 3B 00 00 00	as specified (with LE endianness if not specified)
00 00 FE FF	UTF-32-BE
FF FE 00 00	UTF-32-LE
00 00 FF FE	UTF-32-2143
FE FF 00 00	UTF-32-3412

FE FF	UTF-16-BE
FF FE	UTF-16-LE
7C 83 88 81 99 A2 85 A3 40 7F (YY)* 7F 5E	as specified, transcoded from EBCDIC to ASCII
AE 83 88 81 99 A2 85 A3 40 FC (YY)* FC 5E	as specified, transcoded from IBM1026 to ASCII
00 63 68 61 72 73 65 74 20 22 (YY)* 22 3B	as specified, transcoded from GSM 03.38 to ASCII
analogous patterns	User agents may support additional, analogous, patterns if they support encodings that are not handled by the patterns here

- If the encoding is detected based on one of the entries in the table above marked "as specified", the user agent ignores the style sheet if it does not parse an appropriate @charset rule at the beginning of the stream of characters resulting from decoding in the chosen @charset. This ensures that:
 - @charset rules should only function if they are in the encoding of the style sheet,
 - byte order marks are ignored only in encodings that support a byte order mark, and
 - encoding names cannot contain newlines.

User agents must ignore style sheets in unknown encodings.

4.4.1 Referring to characters not represented in a character encoding

A style sheet may have to refer to characters that cannot be represented in the current character encoding. These characters must be written as escaped [p. 55] references to ISO 10646 characters. These escapes serve the same purpose as numeric character references in HTML or XML documents (see [HTML4], chapters 5 and 25).

The character escape mechanism should be used when only a few characters must be represented this way. If most of a style sheet requires escaping, authors should encode it with a more appropriate encoding (e.g., if the style sheet contains a lot of Greek characters, authors might use "ISO-8859-7" or "UTF-8").

Intermediate processors using a different character encoding may translate these escaped sequences into byte sequences of that encoding. Intermediate processors must not, on the other hand, alter escape sequences that cancel the special meaning of an ASCII character.

Conforming user agents [p. 47] must correctly map to ISO-10646 all characters in any character encodings that they recognize (or they must behave as if they did).

For example, a style sheet transmitted as ISO-8859-1 (Latin-1) cannot contain Greek letters directly: "kouros" (Greek: "kouros") has to be written as "\3BA\3BF\3C5\3C1\3BF\3C2".

Note. In HTML 4, numeric character references are interpreted in "style" attribute values but not in the content of the STYLE element. Because of this asymmetry, we recommend that authors use the CSS character escape mechanism rather than numeric character references for both the "style" attribute and the STYLE element. For example, we recommend:

```
<SPAN style="font-family: L\FC beck">...</SPAN>
```

rather than:

```
<SPAN style="font-family: L&#252;beck">...</SPAN>
```

5 Selectors

Contents

5.1 Pattern matching	77
5.2 Selector syntax	79
5.2.1 Grouping	79
5.3 Universal selector	80
5.4 Type selectors	80
5.5 Descendant selectors	80
5.6 Child selectors	81
5.7 Adjacent sibling selectors	81
5.8 Attribute selectors	82
5.8.1 Matching attributes and attribute values	82
5.8.2 Default attribute values in DTDs	84
5.8.3 Class selectors	85
5.9 ID selectors	86
5.10 Pseudo-elements and pseudo-classes	87
5.11 Pseudo-classes	88
5.11.1 :first-child pseudo-class	88
5.11.2 The link pseudo-classes: :link and :visited	89
5.11.3 The dynamic pseudo-classes: :hover, :active, and :focus	89
5.11.4 The language pseudo-class: :lang	91
5.12 Pseudo-elements	92
5.12.1 The :first-line pseudo-element	92
5.12.2 The :first-letter pseudo-element	94
5.12.3 The :before and :after pseudo-elements	97

5.1 Pattern matching

In CSS, pattern matching rules determine which style rules apply to elements in the document tree [p. 45]. These patterns, called selectors, may range from simple element names to rich contextual patterns. If all conditions in the pattern are true for a certain element, the selector *matches* the element.

The case-sensitivity of document language element names in selectors depends on the document language. For example, in HTML, element names are case-insensitive, but in XML they are case-sensitive.

The following table summarizes CSS 2.1 selector syntax:

Pattern	Meaning	Described in section
---------	---------	----------------------

*	Matches any element.	Universal selector [p. 80]
E	Matches any E element (i.e., an element of type E).	Type selectors [p. 80]
E F	Matches any F element that is a descendant of an E element.	Descendant selectors [p. 80]
E > F	Matches any F element that is a child of an element E.	Child selectors [p. 81]
E:first-child	Matches element E when E is the first child of its parent.	The :first-child pseudo-class [p. 88]
E:link E:visited	Matches element E if E is the source anchor of a hyperlink of which the target is not yet visited (:link) or already visited (:visited).	The link pseudo-classes [p. 89]
E:active E:hover E:focus	Matches E during certain user actions.	The dynamic pseudo-classes [p. 89]
E:lang(c)	Matches element of type E if it is in (human) language c (the document language specifies how language is determined).	The :lang() pseudo-class [p. 91]
E + F	Matches any F element immediately preceded by a sibling element E.	Adjacent selectors [p. 81]
E[foo]	Matches any E element with the "foo" attribute set (whatever the value).	Attribute selectors [p. 82]
E[foo="warning"]	Matches any E element whose "foo" attribute value is exactly equal to "warning".	Attribute selectors [p. 82]
E[foo~="warning"]	Matches any E element whose "foo" attribute value is a list of space-separated values, one of which is exactly equal to "warning".	Attribute selectors [p. 82]
E[lang = "en"]	Matches any E element whose "lang" attribute has a hyphen-separated list of values beginning (from the left) with "en".	Attribute selectors [p. 82]

DIV.warning	<i>Language specific.</i> (In HTML, the same as DIV[class~="warning"].)	Class selectors [p. 85]
E#myid	Matches any E element with ID equal to "myid".	ID selectors [p. 86]

5.2 Selector syntax

A *simple selector* is either a type selector [p. 80] or universal selector [p. 80] followed immediately by zero or more attribute selectors [p. 82], ID selectors [p. 86], or pseudo-classes [p. 87], in any order. The simple selector matches if all of its components match.

Note: the terminology used here in CSS 2.1 is different from what is used in CSS3. For example, a "simple selector" refers to a smaller part of a selector in CSS3 than in CSS 2.1. See the CSS3 Selectors module [CSS3SEL].

A *selector* is a chain of one or more simple selectors separated by combinators. *Combinators* are: white space, ">", and "+". White space may appear between a combinator and the simple selectors around it.

The elements of the document tree that match a selector are called *subjects* of the selector. A selector consisting of a single simple selector matches any element satisfying its requirements. Prepending a simple selector and combinator to a chain imposes additional matching constraints, so the subjects of a selector are always a subset of the elements matching the last simple selector.

One pseudo-element [p. 87] may be appended to the last simple selector in a chain, in which case the style information applies to a subpart of each subject.

5.2.1 Grouping

When several selectors share the same declarations, they may be grouped into a comma-separated list.

Example(s):

In this example, we condense three rules with identical declarations into one. Thus,

```
h1 { font-family: sans-serif }
h2 { font-family: sans-serif }
h3 { font-family: sans-serif }
```

is equivalent to:

```
h1, h2, h3 { font-family: sans-serif }
```

CSS offers other "shorthand" mechanisms as well, including multiple declarations [p. 59] and shorthand properties [p. 32].

5.3 Universal selector

The universal selector, written "*", matches the name of any element type. It matches any single element in the document tree. [p. 45]

If the universal selector is not the only component of a simple selector [p. 79], the "*" may be omitted. For example:

- `*[lang=fr]` and `[lang=fr]` are equivalent.
- `*.warning` and `.warning` are equivalent.
- `*#myid` and `#myid` are equivalent.

5.4 Type selectors

A *type selector* matches the name of a document language element type. A type selector matches every instance of the element type in the document tree.

Example(s):

The following rule matches all H1 elements in the document tree:

```
h1 { font-family: sans-serif }
```

5.5 Descendant selectors

At times, authors may want selectors to match an element that is the descendant of another element in the document tree (e.g., "Match those EM elements that are contained by an H1 element"). Descendant selectors express such a relationship in a pattern. A descendant selector is made up of two or more selectors separated by white space [p. 53]. A descendant selector of the form "A B" matches when an element B is an arbitrary descendant of some ancestor [p. 45] element A.

Example(s):

For example, consider the following rules:

```
h1 { color: red }
em { color: red }
```

Although the intention of these rules is to add emphasis to text by changing its color, the effect will be lost in a case such as:

```
<H1>This headline is <EM>very</EM> important</H1>
```

We address this case by supplementing the previous rules with a rule that sets the text color to blue whenever an EM occurs anywhere within an H1:

```
h1 { color: red }
em { color: red }
h1 em { color: blue }
```

The third rule will match the EM in the following fragment:

```
<H1>This <SPAN class="myclass">headline
is <EM>very</EM> important</SPAN></H1>
```

Example(s):

The following selector:

```
div * p
```

matches a P element that is a grandchild or later descendant of a DIV element. Note the white space on either side of the "*" is not part of the universal selector; the white space is a combinator indicating that the DIV must be the ancestor of some element, and that that element must be an ancestor of the P.

Example(s):

The selector in the following rule, which combines descendant and attribute selectors [p. 82], matches any element that (1) has the "href" attribute set and (2) is inside a P that is itself inside a DIV:

```
div p *[href]
```

5.6 Child selectors

A *child selector* matches when an element is the child [p. 45] of some element. A child selector is made up of two or more selectors separated by ">".

Example(s):

The following rule sets the style of all P elements that are children of BODY:

```
body > P { line-height: 1.3 }
```

Example(s):

The following example combines descendant selectors and child selectors:

```
div ol>li p
```

It matches a P element that is a descendant of an LI; the LI element must be the child of an OL element; the OL element must be a descendant of a DIV. Notice that the optional white space around the ">" combinator has been left out.

For information on selecting the first child of an element, please see the section on the :first-child [p. 88] pseudo-class below.

5.7 Adjacent sibling selectors

Adjacent sibling selectors have the following syntax: E1 + E2, where E2 is the subject of the selector. The selector matches if E1 and E2 share the same parent in the document tree and E1 immediately precedes E2, ignoring non-element nodes (such as text nodes and comments).

Example(s):

Thus, the following rule states that when a P element immediately follows a MATH element, it should not be indented:

```
math + p { text-indent: 0 }
```

The next example reduces the vertical space separating an H1 and an H2 that immediately follows it:

```
h1 + h2 { margin-top: -5mm }
```

Example(s):

The following rule is similar to the one in the previous example, except that it adds a class selector. Thus, special formatting only occurs when H1 has `class="opener"`:

```
h1.opener + h2 { margin-top: -5mm }
```

5.8 Attribute selectors

CSS 2.1 allows authors to specify rules that match elements which have certain attributes defined in the source document.

5.8.1 Matching attributes and attribute values

Attribute selectors may match in four ways:

[att]

Match when the element sets the "att" attribute, whatever the value of the attribute.

[att=val]

Match when the element's "att" attribute value is exactly "val".

[att~=val]

Represents an element with the att attribute whose value is a white space-separated list of words, one of which is exactly "val". If "val" contains white space, it will never represent anything (since the words are *separated* by spaces). If "val" is the empty string, it will never represent anything either.

[att|=val]

Represents an element with the att attribute, its value either being exactly "val" or beginning with "val" immediately followed by "-" (U+002D). This is primarily intended to allow language subcode matches (e.g., the hreflang attribute on the a element in HTML) as described in BCP 47 ([BCP47]) or its successor. For lang (or xml:lang) language subcode matching, please see the :lang pseudo-class [p. 91].

Attribute values must be identifiers or strings. The case-sensitivity of attribute names and values in selectors depends on the document language.

Example(s):

For example, the following attribute selector matches all H1 elements that specify the "title" attribute, whatever its value:

```
h1[title] { color: blue; }
```

Example(s):

In the following example, the selector matches all SPAN elements whose "class" attribute has exactly the value "example":

```
span[class=example] { color: blue; }
```

Multiple attribute selectors can be used to refer to several attributes of an element, or even several times to the same attribute.

Example(s):

Here, the selector matches all SPAN elements whose "hello" attribute has exactly the value "Cleveland" and whose "goodbye" attribute has exactly the value "Columbus":

```
span[hello="Cleveland"][goodbye="Columbus"] { color: blue; }
```

Example(s):

The following selectors illustrate the differences between "=" and "~=". The first selector will match, for example, the value "copyright copyleft copyeditor" for the "rel" attribute. The second selector will only match when the "href" attribute has the value "http://www.w3.org/".

```
a[rel~="copyright"]
a[href="http://www.w3.org/"]
```

Example(s):

The following rule hides all elements for which the value of the "lang" attribute is "fr" (i.e., the language is French).

```
*[lang=fr] { display : none }
```

Example(s):

The following rule will match for values of the "lang" attribute that begin with "en", including "en", "en-US", and "en-cockney":

```
*[lang|= "en"] { color : red }
```

Example(s):

Similarly, the following aural style sheet rules allow a script to be read aloud in different voices for each role:

```
DIALOGUE[character=romeo]
  { voice-family: "Laurence Olivier", charles, male }

DIALOGUE[character=juliet]
  { voice-family: "Vivien Leigh", victoria, female }
```

5.8.2 Default attribute values in DTDs

Matching takes place on attribute values in the document tree. Default attribute values may be defined in a DTD or elsewhere, but cannot always be selected by attribute selectors. Style sheets should be designed so that they work even if the default values are not included in the document tree.

More precisely, a UA may, but is *not* required to, read an "external subset" of the DTD but *is* required to look for default attribute values in the document's "internal subset." (See [XML10] for definitions of these subsets.) Depending on the UA, a default attribute value defined in the external subset of the DTD might or might not appear in the document tree.

A UA that recognizes an XML namespace [XMLNAMESPACES] may, but is not required to, use its knowledge of that namespace to treat default attribute values as if they were present in the document. (E.g., an XHTML UA is not required to use its built-in knowledge of the XHTML DTD.)

Note that, typically, implementations choose to ignore external subsets.

Example(s):

Example:

For example, consider an element EXAMPLE with an attribute "notation" that has a default value of "decimal". The DTD fragment might be

```
<!ATTLIST EXAMPLE notation (decimal,octal) "decimal">
```

If the style sheet contains the rules

```
EXAMPLE[notation=decimal] { /*... default property settings ...*/ }
EXAMPLE[notation=octal]   { /*... other settings...*/ }
```

the first rule might not match elements whose "notation" attribute is set by default, i.e., not set explicitly. To catch all cases, the attribute selector for the default value must be dropped:

```
EXAMPLE                    { /*... default property settings ...*/ }
EXAMPLE[notation=octal]   { /*... other settings...*/ }
```

Here, because the selector EXAMPLE[notation=octal] is more specific [p. 105] than the type selector alone, the style declarations in the second rule will override those in the first for elements that have a "notation" attribute value of "octal". Care has to be taken that all property declarations that are to apply only to the default case are overridden in the non-default cases' style rules.

5.8.3 Class selectors

Working with HTML, authors may use the period (.) notation as an alternative to the ~ notation when representing the class attribute. Thus, for HTML, `div.value` and `div[class~value]` have the same meaning. The attribute value must immediately follow the "period" (.). UAs may apply selectors using the period (.) notation in XML documents if the UA has namespace specific knowledge that allows it to determine which attribute is the "class" attribute for the respective namespace. One such example of namespace specific knowledge is the prose in the specification for a particular namespace (e.g., SVG 1.1 [SVG11] describes the SVG "class" attribute [p. ??] and how a UA should interpret it, and similarly MathML 2.0 [MATH20] describes the MathML "class" attribute [p. ??].)

Example(s):

For example, we can assign style information to all elements with `class~="pastoral"` as follows:

```
*.pastoral { color: green } /* all elements with class~=pastoral */
```

or just

```
.pastoral { color: green } /* all elements with class~=pastoral */
```

The following assigns style only to H1 elements with `class~="pastoral"`:

```
H1.pastoral { color: green } /* H1 elements with class~=pastoral */
```

Given these rules, the first H1 instance below would not have green text, while the second would:

```
<H1>Not green</H1>
<H1 class="pastoral">Very green</H1>
```

To match a subset of "class" values, each value must be preceded by a ".".

Example(s):

For example, the following rule matches any P element whose "class" attribute has been assigned a list of space-separated values that includes "pastoral" and "marine":

```
p.marine.pastoral { color: green }
```

This rule matches when `class="pastoral blue aqua marine"` but does not match for `class="pastoral blue"`.

Note. *CSS gives so much power to the "class" attribute, that authors could conceivably design their own "document language" based on elements with almost no associated presentation (such as DIV and SPAN in HTML) and assigning style information through the "class" attribute. Authors should avoid this practice since the structural elements of a document language often have recognized and accepted meanings and author-defined classes may not.*

Note: If an element has multiple class attributes, their values must be concatenated with spaces between the values before searching for the class. As of this time the working group is not aware of any manner in which this situation can be reached, however, so this behavior is explicitly non-normative in this specification.

5.9 ID selectors

Document languages may contain attributes that are declared to be of type ID. What makes attributes of type ID special is that no two such attributes can have the same value; whatever the document language, an ID attribute can be used to uniquely identify its element. In HTML all ID attributes are named "id"; XML applications may name ID attributes differently, but the same restriction applies.

The ID attribute of a document language allows authors to assign an identifier to one element instance in the document tree. CSS ID selectors match an element instance based on its identifier. A CSS ID selector contains a "#" immediately followed by the ID value, which must be an identifier.

Note that CSS does not specify how a UA knows the ID attribute of an element. The UA may, e.g., read a document's DTD, have the information hard-coded or ask the user.

Example(s):

The following ID selector matches the H1 element whose ID attribute has the value "chapter1":

```
h1#chapter1 { text-align: center }
```

In the following example, the style rule matches the element that has the ID value "z98y". The rule will thus match for the P element:

```
<HEAD>
  <TITLE>Match P</TITLE>
  <STYLE type="text/css">
    *#z98y { letter-spacing: 0.3em }
  </STYLE>
</HEAD>
<BODY>
  <P id=z98y>Wide text</P>
</BODY>
```

In the next example, however, the style rule will only match an H1 element that has an ID value of "z98y". The rule will not match the P element in this example:

```
<HEAD>
  <TITLE>Match H1 only</TITLE>
  <STYLE type="text/css">
    H1#z98y { letter-spacing: 0.5em }
  </STYLE>
</HEAD>
<BODY>
  <P id=z98y>Wide text</P>
</BODY>
```

ID selectors have a higher specificity than attribute selectors. For example, in HTML, the selector `#p123` is more specific than `[id=p123]` in terms of the cascade [p. 99].

Note. In XML 1.0 [XML10], the information about which attribute contains an element's IDs is contained in a DTD. When parsing XML, UAs do not always read the DTD, and thus may not know what the ID of an element is. If a style sheet designer knows or suspects that this will be the case, he should use normal attribute selectors instead: `[name=p371]` instead of `#p371`. However, the cascading order of normal attribute selectors is different from ID selectors. It may be necessary to add an "important" priority to the declarations: `[name=p371] {color: red !important}`.

If an element has multiple ID attributes, all of them must be treated as IDs for that element for the purposes of the ID selector. Such a situation could be reached using mixtures of `xml:id` [XMLID], DOM3 Core [DOM-LEVEL-3-CORE], XML DTDs [XML10] and namespace-specific knowledge.

5.10 Pseudo-elements and pseudo-classes

In CSS 2.1, style is normally attached to an element based on its position in the document tree [p. 45]. This simple model is sufficient for many cases, but some common publishing scenarios may not be possible due to the structure of the document tree [p. 45]. For instance, in HTML 4 (see [HTML4]), no element refers to the first line of a paragraph, and therefore no simple CSS selector may refer to it.

CSS introduces the concepts of *pseudo-elements* and *pseudo-classes* to permit formatting based on information that lies outside the document tree.

- Pseudo-elements create abstractions about the document tree beyond those specified by the document language. For instance, document languages do not offer mechanisms to access the first letter or first line of an element's content. CSS pseudo-elements allow style sheet designers to refer to this otherwise inaccessible information. Pseudo-elements may also provide style sheet designers a way to assign style to content that does not exist in the source document (e.g., the `:before` and `:after` [p. 203] pseudo-elements give access to generated content).
- Pseudo-classes classify elements on characteristics other than their name, attributes or content; in principle characteristics that cannot be deduced from the document tree. Pseudo-classes may be dynamic, in the sense that an element may acquire or lose a pseudo-class while a user interacts with the document. The exceptions are `:first-child` [p. 88], which *can* be deduced from the document tree, and `:lang()` [p. 91], which can be deduced from the document tree in some cases.

Neither pseudo-elements nor pseudo-classes appear in the document source or document tree.

Pseudo-classes are allowed anywhere in selectors while pseudo-elements may only be appended after the last simple selector of the selector.

Pseudo-element and pseudo-class names are case-insensitive.

Some pseudo-classes are mutually exclusive, while others can be applied simultaneously to the same element. In case of conflicting rules, the normal cascading order [p. 103] determines the outcome.

5.11 Pseudo-classes

5.11.1 :first-child pseudo-class

The :first-child pseudo-class matches an element that is the first child element of some other element.

Example(s):

In the following example, the selector matches any P element that is the first child of a DIV element. The rule suppresses indentation for the first paragraph of a DIV:

```
div > p:first-child { text-indent: 0 }
```

This selector would match the P inside the DIV of the following fragment:

```
<P> The last P before the note.
<DIV class="note">
  <P> The first P inside the note.
</DIV>
```

but would not match the second P in the following fragment:

```
<P> The last P before the note.
<DIV class="note">
  <H2>Note</H2>
  <P> The first P inside the note.
</DIV>
```

Example(s):

The following rule sets the font weight to 'bold' for any EM element that is some descendant of a P element that is a first child:

```
p:first-child em { font-weight : bold }
```

Note that since anonymous [p. 132] boxes are not part of the document tree, they are not counted when calculating the first child.

For example, the EM in:

```
<P>abc <EM>default</EM>
```

is the first child of the P.

The following two selectors are equivalent:

```
* > a:first-child /* A is first child of any element */
a:first-child /* Same */
```

5.11.2 The link pseudo-classes: `:link` and `:visited`

User agents commonly display unvisited links differently from previously visited ones. CSS provides the pseudo-classes `:link` and `:visited` to distinguish them:

- The `:link` pseudo-class applies for links that have not yet been visited.
- The `:visited` pseudo-class applies once the link has been visited by the user.

UAs may return a visited link to the (unvisited) `:link` state at some point.

The two states are mutually exclusive.

The document language determines which elements are hyperlink source anchors. For example, in HTML4, the link pseudo-classes apply to A elements with an "href" attribute. Thus, the following two CSS 2.1 declarations have similar effect:

```
a:link { color: red }
:link { color: red }
```

Example(s):

If the following link:

```
<A class="external" href="http://out.side/">external link</A>
```

has been visited, this rule:

```
a.external:visited { color: blue }
```

will cause it to be blue.

Note. It is possible for style sheet authors to abuse the `:link` and `:visited` pseudo-classes to determine which sites a user has visited without the user's consent.

UAs may therefore treat all links as unvisited links, or implement other measures to preserve the user's privacy while rendering visited and unvisited links differently. See [P3P] for more information about handling privacy.

5.11.3 The dynamic pseudo-classes: `:hover`, `:active`, and `:focus`

Interactive user agents sometimes change the rendering in response to user actions. CSS provides three pseudo-classes for common cases:

- The `:hover` pseudo-class applies while the user designates an element (with some pointing device), but does not activate it. For example, a visual user agent could apply this pseudo-class when the cursor (mouse pointer) hovers over a

box generated by the element. User agents not supporting interactive media [p. 110] do not have to support this pseudo-class. Some conforming user agents supporting interactive media [p. 110] may not be able to support this pseudo-class (e.g., a pen device).

- The `:active` pseudo-class applies while an element is being activated by the user. For example, between the times the user presses the mouse button and releases it.
- The `:focus` pseudo-class applies while an element has the focus (accepts keyboard events or other forms of text input).

An element may match several pseudo-classes at the same time.

CSS does not define which elements may be in the above states, or how the states are entered and left. Scripting may change whether elements react to user events or not, and different devices and UAs may have different ways of pointing to, or activating elements.

CSS 2.1 does not define if the parent of an element that is `:active` or `:hover` is also in that state.

User agents are not required to reflow a currently displayed document due to pseudo-class transitions. For instance, a style sheet may specify that the `'font-size'` of an `:active` link should be larger than that of an inactive link, but since this may cause letters to change position when the reader selects the link, a UA may ignore the corresponding style rule.

Example(s):

```
a:link      { color: red }      /* unvisited links */
a:visited  { color: blue }    /* visited links   */
a:hover    { color: yellow }  /* user hovers     */
a:active   { color: lime }    /* active links    */
```

Note that the `A:hover` must be placed after the `A:link` and `A:visited` rules, since otherwise the cascading rules will hide the `'color'` property of the `A:hover` rule. Similarly, because `A:active` is placed after `A:hover`, the active color (lime) will apply when the user both activates and hovers over the `A` element.

Example(s):

An example of combining dynamic pseudo-classes:

```
a:focus { background: yellow }
a:focus:hover { background: white }
```

The last selector matches `A` elements that are in pseudo-class `:focus` and in pseudo-class `:hover`.

For information about the presentation of focus outlines, please consult the section on dynamic focus outlines [p. 300] .

Note. In CSS1, the `:active` pseudo-class was mutually exclusive with `:link` and `:visited`. That is no longer the case. An element can be both `:visited` and `:active` (or `:link` and `:active`) and the normal cascading rules determine which style declarations apply.

Note. Also note that in CSS1, the `:active` pseudo-class only applied to links.

5.11.4 The language pseudo-class: `:lang`

If the document language specifies how the human language of an element is determined, it is possible to write selectors in CSS that match an element based on its language. For example, in HTML [HTML4], the language is determined by a combination of the "lang" attribute, the META element, and possibly by information from the protocol (such as HTTP headers). XML uses an attribute called `xml:lang`, and there may be other document language-specific methods for determining the language.

The pseudo-class `:lang(C)` matches if the element is in language C. Whether there is a match is based solely on the identifier C being either equal to, or a hyphen-separated substring of, the element's language value, in the same way as if performed by the `|=` [p. 82] operator. The matching of C against the element's language value is performed case-insensitively for characters within the ASCII range. The identifier C does not have to be a valid language name.

C must not be empty.

Note: It is recommended that documents and protocols indicate language using codes from BCP 47 [BCP47] or its successor, and by means of "xml:lang" attributes in the case of XML-based documents [XML10]. See "FAQ: Two-letter or three-letter language codes." [p. ??]

Example(s):

The following rules set the quotation marks for an HTML document that is either in Canadian French or German:

```
html:lang(fr-ca) { quotes: '« ' ' »' }
html:lang(de) { quotes: '»' '«' '\2039' '\203A' }
:lang(fr) > Q { quotes: '« ' ' »' }
:lang(de) > Q { quotes: '»' '«' '\2039' '\203A' }
```

The second pair of rules actually set the `'quotes'` property on Q elements according to the language of its parent. This is done because the choice of quote marks is typically based on the language of the element around the quote, not the quote itself: like this piece of French "à l'improviste" in the middle of an English text uses the English quotation marks.

Note the difference between `[lang=xx]` and `:lang(xx)`. In this HTML example, only the BODY matches `[lang=fr]` (because it has a LANG attribute) but both the BODY and the P match `:lang(fr)` (because both are in French).

```
<body lang=fr>
  <p>Je suis Français.</p>
</body>
```

5.12 Pseudo-elements

Pseudo-elements behave just like real elements in CSS with the exceptions described below and elsewhere. [p. 203]

5.12.1 The :first-line pseudo-element

The :first-line pseudo-element applies special styles to the contents of the first formatted line of a paragraph. For instance:

```
p:first-line { text-transform: uppercase }
```

The above rule means "change the letters of the first line of every paragraph to uppercase". However, the selector "P:first-line" does not match any real HTML element. It does match a pseudo-element that conforming user agents [p. 47] will insert at the beginning of every paragraph.

Note that the length of the first line depends on a number of factors, including the width of the page, the font size, etc. Thus, an ordinary HTML paragraph such as:

```
<P>This is a somewhat long HTML
paragraph that will be broken into several
lines. The first line will be identified
by a fictional tag sequence. The other lines
will be treated as ordinary lines in the
paragraph.</P>
```

the lines of which happen to be broken as follows:

```
THIS IS A SOMEWHAT LONG HTML PARAGRAPH THAT
will be broken into several lines. The first
line will be identified by a fictional tag
sequence. The other lines will be treated as
ordinary lines in the paragraph.
```

might be "rewritten" by user agents to include the *fictional tag sequence* for :first-line. This fictional tag sequence helps to show how properties are inherited.

```
<P><P:first-line> This is a somewhat long HTML
paragraph that </P:first-line> will be broken into several
lines. The first line will be identified
by a fictional tag sequence. The other lines
will be treated as ordinary lines in the
paragraph.</P>
```

If a pseudo-element breaks up a real element, the desired effect can often be described by a fictional tag sequence that closes and then re-opens the element. Thus, if we mark up the previous paragraph with a SPAN element:

```
<P><SPAN class="test"> This is a somewhat long HTML
paragraph that will be broken into several
lines.</SPAN> The first line will be identified
by a fictional tag sequence. The other lines
will be treated as ordinary lines in the
paragraph.</P>
```

the user agent could simulate start and end tags for SPAN when inserting the fictional tag sequence for `:first-line`.

```
<P><P:first-line><SPAN class="test"> This is a
somewhat long HTML
paragraph that will </SPAN></P:first-line><SPAN class="test"> be
broken into several
lines.</SPAN> The first line will be identified
by a fictional tag sequence. The other lines
will be treated as ordinary lines in the
paragraph.</P>
```

The `:first-line` pseudo-element can only be attached to a block container element.
[p. 129]

The "first formatted line" of an element may occur inside a block-level descendant in the same flow (i.e., a block-level descendant that is not positioned and not a float). E.g., the first line of the DIV in `<DIV><P>This line...</P></DIV>` is the first line of the P (assuming that both P and DIV are block-level).

The first line of a table-cell or inline-block cannot be the first formatted line of an ancestor element. Thus, in `<DIV><P STYLE="display:inline-block">Hello
Goodbye</P> etcetera</DIV>` the first formatted line of the DIV is not the line "Hello".

Note that the first line of the P in this fragment: `<p>
First...</p>` does not contain any letters (assuming the default style for BR in HTML 4). The word "First" is not on the first formatted line.

A UA should act as if the fictional start tags of the first-line pseudo-elements were nested just inside the innermost enclosing block-level element. (Since CSS1 and CSS2 were silent on this case, authors should not rely on this behavior.) Here is an example. The fictional tag sequence for

```
<DIV>
  <P>First paragraph</P>
  <P>Second paragraph</P>
</DIV>
```

is

```
<DIV>
  <P><DIV:first-line><P:first-line>First paragraph</P:first-line></DIV:first-line></P>
  <P><P:first-line>Second paragraph</P:first-line></P>
</DIV>
```

The `:first-line` pseudo-element is similar to an inline-level element, but with certain restrictions. The following properties apply to a `:first-line` pseudo-element: font properties, [p. 241] color property, [p. 231] background properties, [p. 232] `'word-spacing'`, `'letter-spacing'`, `'text-decoration'`, `'vertical-align'`, `'text-transform'`, `'line-height'`,. UAs may apply other properties as well.

5.12.2 The `:first-letter` pseudo-element

The `:first-letter` pseudo-element must select the first letter of the first line of a block, if it is not preceded by any other content (such as images or inline tables) on its line. The `:first-letter` pseudo-element may be used for "initial caps" and "drop caps", which are common typographical effects. This type of initial letter is similar to an inline-level element if its `'float'` property is `'none'`, otherwise it is similar to a floated element.

These are the properties that apply to `:first-letter` pseudo-elements: font properties, [p. 241] `'text-decoration'`, `'text-transform'`, `'letter-spacing'`, `'word-spacing'` (when appropriate), `'line-height'`, `'float'`, `'vertical-align'` (only if `'float'` is `'none'`), margin properties, [p. 115] padding properties, [p. 118] border properties, [p. 120] color property, [p. 231] background properties. [p. 232] UAs may apply other properties as well. To allow UAs to render a typographically correct drop cap or initial cap, the UA may choose a line-height, width and height based on the shape of the letter, unlike for normal elements. CSS3 is expected to have specific properties that apply to `first-letter`.

This example shows a possible rendering of an initial cap. Note that the `'line-height'` that is inherited by the `first-letter` pseudo-element is 1.1, but the UA in this example has computed the height of the first letter differently, so that it does not cause any unnecessary space between the first two lines. Also note that the fictional start tag of the first letter is inside the SPAN, and thus the font weight of the first letter is normal, not bold as the SPAN:

```
p { line-height: 1.1 }
p:first-letter { font-size: 3em; font-weight: normal }
span { font-weight: bold }
...
<p><span>Het hemelsche</span> gerecht heeft zich ten lange lesten<br>
Erbarremt over my en mijn benaeuwde vesten<br>
En arme burgery, en op mijn volcx gebed<br>
En dagelix geschrey de bange stad ontzet.
```

Het hemelsche gerecht heeft zich ten lange lesten
 Erbarremt over my en mijn benaeuwde vesten
 En arme burgery, en op mijn volcx gebed
 En dagelix geschrey de bange stad ontzet.

The following CSS 2.1 will make a drop cap initial letter span about two lines:

```

<!DOCTYPE HTML PUBLIC "-//W3C//DTD HTML 4.01//EN">
<HTML>
  <HEAD>
    <TITLE>Drop cap initial letter</TITLE>
    <STYLE type="text/css">
      P
      { font-size: 12pt; line-height: 1.2 }
      P:first-letter { font-size: 200%; font-style: italic;
                      font-weight: bold; float: left }
      SPAN
      { text-transform: uppercase }
    </STYLE>
  </HEAD>
  <BODY>
    <P><SPAN>The first</SPAN> few words of an article
      in The Economist.</P>
  </BODY>
</HTML>

```

This example might be formatted as follows:

THE FIRST few
words of an
article in the
Economist

The fictional tag sequence is:

```

<P>
<SPAN>
<P:first-letter>
T
</P:first-letter>he first
</SPAN>
few words of an article in the Economist.
</P>

```

Note that the `:first-letter` pseudo-element tags about the content (i.e., the initial character), while the `:first-line` pseudo-element start tag is inserted right after the start tag of the block element.

In order to achieve traditional drop caps formatting, user agents may approximate font sizes, for example to align baselines. Also, the glyph outline may be taken into account when formatting.

Punctuation (i.e, characters defined in Unicode [UNICODE] in the "open" (Ps), "close" (Pe), "initial" (Pi), "final" (Pf) and "other" (Po) punctuation classes), that precedes or follows the first letter should be included, as in:

"A bird in
the hand
is worth
two in the bush,"
says an old proverb.

The `:first-letter` also applies if the first letter is in fact a digit, e.g., the "6" in "67 million dollars is a lot of money."

The `:first-letter` pseudo-element applies to block container elements. [p. 129]

The `:first-letter` pseudo-element can be used with all such elements that contain text, or that have a descendant in the same flow that contains text. A UA should act as if the fictional start tag of the first-letter pseudo-element is just before the first text of the element, even if that first text is in a descendant.

Example(s):

Here is an example. The fictional tag sequence for this HTML fragment:

```
<div>
<p>The first text.
```

is:

```
<div>
<p><div:first-letter><p:first-letter>T</...></...>he first text.
```

The first letter of a table-cell or inline-block cannot be the first letter of an ancestor element. Thus, in `<DIV><P STYLE="display:inline-block">Hello
Goodbye</P> etcetera</DIV>` the first letter of the DIV is not the letter "H". In fact, the DIV does not have a first letter.

The first letter must occur on the first formatted line. [p. 93] For example, in this fragment: `<p>
First . . .` the first line does not contain any letters and `:first-letter` does not match anything (assuming the default style for BR in HTML 4). In particular, it does not match the "F" of "First."

If an element is a list item [p. 214] (`display: list-item`), the `:first-letter` applies to the first letter in the principal box after the marker. UAs may ignore `:first-letter` on list items with `list-style-position: inside`. If an element has `:before` or `:after` content, the `:first-letter` applies to the first letter of the element *including* that content.

E.g., after the rule `'p:before {content: "Note: "}`, the selector `'p:first-letter'` matches the "N" of "Note".

Some languages may have specific rules about how to treat certain letter combinations. In Dutch, for example, if the letter combination "ij" appears at the beginning of a word, both letters should be considered within the `:first-letter` pseudo-element.

If the letters that would form the first-letter are not in the same element, such as "T" in `<p>'T. . .`, the UA may create a first-letter pseudo-element from one of the elements, both elements, or simply not create a pseudo-element.

Similarly, if the first letter(s) of the block are not at the start of the line (for example due to bidirectional reordering), then the UA need not create the pseudo-element(s).

Example(s):

The following example illustrates how overlapping pseudo-elements may interact. The first letter of each P element will be green with a font size of '24pt'. The rest of the first formatted line will be 'blue' while the rest of the paragraph will be 'red'.

```
p { color: red; font-size: 12pt }
p:first-letter { color: green; font-size: 200% }
p:first-line { color: blue }
```

```
<P>Some text that ends up on two lines</P>
```

Assuming that a line break will occur before the word "ends", the fictional tag sequence for this fragment might be:

```
<P>
<P:first-line>
<P:first-letter>
S
</P:first-letter>ome text that
</P:first-line>
ends up on two lines
</P>
```

Note that the `:first-letter` element is inside the `:first-line` element. Properties set on `:first-line` are inherited by `:first-letter`, but are overridden if the same property is set on `:first-letter`.

5.12.3 The `:before` and `:after` pseudo-elements

The `:before` and `:after` pseudo-elements can be used to insert generated content before or after an element's content. They are explained in the section on generated text. [p. 203]

Example(s):

```
h1:before {content: counter(chapno, upper-roman) ". "}
```

When the `:first-letter` and `:first-line` pseudo-elements are applied to an element having content generated using `:before` and `:after`, they apply to the first letter or line of the element including the generated content.

Example(s):

```
p.special:before {content: "Special! "}
p.special:first-letter {color: #ffd800}
```

This will render the "S" of "Special!" in gold.

6 Assigning property values, Cascading, and Inheritance

Contents

6.1 Specified, computed, and actual values	99
6.1.1 Specified values	99
6.1.2 Computed values	100
6.1.3 Used values	100
6.1.4 Actual values	100
6.2 Inheritance	100
6.2.1 The 'inherit' value	101
6.3 The @import rule	102
6.4 The cascade	103
6.4.1 Cascading order	103
6.4.2 !important rules	104
6.4.3 Calculating a selector's specificity	105
6.4.4 Precedence of non-CSS presentational hints	105

6.1 Specified, computed, and actual values

Once a user agent has parsed a document and constructed a document tree [p. 45] , it must assign, for every element in the tree, a value to every property that applies to the target media type [p. 107] .

The final value of a property is the result of a four-step calculation: the value is determined through specification (the "specified value"), then resolved into a value that is used for inheritance (the "computed value"), then converted into an absolute value if necessary (the "used value"), and finally transformed according to the limitations of the local environment (the "actual value").

6.1.1 Specified values

User agents must first assign a specified value to each property based on the following mechanisms (in order of precedence):

1. If the cascade [p. 103] results in a value, use it.
2. Otherwise, if the property is inherited [p. 100] and the element is not the root of the document tree, use the computed value of the parent element.
3. Otherwise use the property's initial value. The initial value of each property is indicated in the property's definition.

6.1.2 Computed values

Specified values are resolved to computed values during the cascade; for example URIs are made absolute and 'em' and 'ex' units are computed to pixel or absolute lengths. Computing a value never requires the user agent to render the document.

The computed value of URIs that the UA cannot resolve to absolute URIs is the specified value.

When the specified value is not 'inherit', the computed value of a property is determined as specified by the Computed Value line in the definition of the property. See the section on inheritance [p. 100] for the definition of computed values when the specified value is 'inherit'.

The computed value exists even when the property does not apply, as defined by the 'Applies To' [p. 31] line. However, some properties may define the computed value of a property for an element to depend on whether the property applies to that element.

6.1.3 Used values

Computed values are processed as far as possible without formatting the document. Some values, however, can only be determined when the document is being laid out. For example, if the width of an element is set to be a certain percentage of its containing block, the width cannot be determined until the width of the containing block has been determined. The *used value* is the result of taking the computed value and resolving any remaining dependencies into an absolute value.

6.1.4 Actual values

A used value is in principle the value used for rendering, but a user agent may not be able to make use of the value in a given environment. For example, a user agent may only be able to render borders with integer pixel widths and may therefore have to approximate the computed width, or the user agent may be forced to use only black and white shades instead of full color. The actual value is the used value after any approximations have been applied.

6.2 Inheritance

Some values are inherited by the children of an element in the document tree [p. 45], as described above [p. 99]. Each property defines [p. 29] whether it is inherited or not.

Suppose there is an H1 element with an emphasizing element (EM) inside:

```
<H1>The headline <EM>is</EM> important!</H1>
```

If no color has been assigned to the EM element, the emphasized "is" will inherit the color of the parent element, so if H1 has the color blue, the EM element will likewise be in blue.

When inheritance occurs, elements inherit computed values. The computed value from the parent element becomes both the specified value and the computed value on the child.

Example(s):

For example, given the following style sheet:

```
body { font-size: 10pt }
h1 { font-size: 130% }
```

and this document fragment:

```
<BODY>
  <H1>A <EM>large</EM> heading</H1>
</BODY>
```

the 'font-size' property for the H1 element will have the computed value '13pt' (130% times 10pt, the parent's value). Since the computed value of 'font-size' is inherited, the EM element will have the computed value '13pt' as well. If the user agent does not have the 13pt font available, the actual value of 'font-size' for both H1 and EM might be, for example, '12pt'.

Note that inheritance follows the document tree and is not intercepted by anonymous boxes. [p. 129]

6.2.1 The 'inherit' value

Each property may also have a specified value of 'inherit', which means that, for a given element, the property takes the same computed value as the property for the element's parent. The 'inherit' value can be used to strengthen inherited values, and it can also be used on properties that are not normally inherited.

If the 'inherit' value is set on the root element, the property is assigned its initial value.

Example(s):

In the example below, the 'color' and 'background' properties are set on the BODY element. On all other elements, the 'color' value will be inherited and the background will be transparent. If these rules are part of the user's style sheet, black text on a white background will be enforced throughout the document.

```
body {
  color: black !important;
  background: white !important;
}

* {
  color: inherit !important;
  background: transparent !important;
}
```

6.3 The @import rule

The '*@import*' rule allows users to import style rules from other style sheets. In CSS 2.1, any @import rules must precede all other rules (except the @charset rule, if present). See the section on parsing [p. 57] for when user agents must ignore @import rules. The '@import' keyword must be followed by the URI of the style sheet to include. A string is also allowed; it will be interpreted as if it had url(...) around it.

Example(s):

The following lines are equivalent in meaning and illustrate both '@import' syntaxes (one with "url()" and one with a bare string):

```
@import "mystyle.css";
@import url("mystyle.css");
```

So that user agents can avoid retrieving resources for unsupported media types [p. 107], authors may specify media-dependent @import rules. These conditional imports specify comma-separated media types after the URI.

Example(s):

The following rules illustrate how @import rules can be made media-dependent:

```
@import url("fineprint.css") print;
@import url("bluish.css") projection, tv;
```

In the absence of any media types, the import is unconditional. Specifying 'all' for the medium has the same effect. The import only takes effect if the target medium matches the media list.

A target medium matches a media list if one of the items in the media list is the target medium or 'all'.

Note that Media Queries [MEDIAQ] extends the syntax of media lists and the definition of matching.

When the same style sheet is imported or linked to a document in multiple places, user agents must process (or act as though they do) each link as though the link were to a separate style sheet.

6.4 The cascade

Style sheets may have three different origins: author, user, and user agent.

- **Author.** The author specifies style sheets for a source document according to the conventions of the document language. For instance, in HTML, style sheets may be included in the document or linked externally.
- **User:** The user may be able to specify style information for a particular document. For example, the user may specify a file that contains a style sheet or the user agent may provide an interface that generates a user style sheet (or behaves as if it did).
- **User agent:** Conforming user agents [p. 47] must apply a *default style sheet* (or behave as if they did). A user agent's default style sheet should present the elements of the document language in ways that satisfy general presentation expectations for the document language (e.g., for visual browsers, the EM element in HTML is presented using an italic font). See A sample style sheet for HTML [p. 435] for a recommended default style sheet for HTML documents.

Note that the user may modify system settings (e.g., system colors) that affect the default style sheet. However, some user agent implementations make it impossible to change the values in the default style sheet.

Style sheets from these three origins will overlap in scope, and they interact according to the cascade.

The CSS cascade assigns a weight to each style rule. When several rules apply, the one with the greatest weight takes precedence.

By default, rules in author style sheets have more weight than rules in user style sheets. Precedence is reversed, however, for "!important" rules. All user and author rules have more weight than rules in the UA's default style sheet.

6.4.1 Cascading order

To find the value for an element/property combination, user agents must apply the following sorting order:

1. Find all declarations that apply to the element and property in question, for the target media type [p. 107]. Declarations apply if the associated selector matches [p. 77] the element in question and the target medium matches the media list on all @media rules containing the declaration and on all links on the path through which the style sheet was reached.
2. Sort according to importance (normal or important) and origin (author, user, or user agent). In ascending order of precedence:
 1. user agent declarations
 2. user normal declarations
 3. author normal declarations
 4. author important declarations

5. user important declarations
3. Sort rules with the same importance and origin by specificity [p. 105] of selector: more specific selectors will override more general ones. Pseudo-elements and pseudo-classes are counted as normal elements and classes, respectively.
4. Finally, sort by order specified: if two declarations have the same weight, origin and specificity, the latter specified wins. Declarations in imported style sheets are considered to be before any declarations in the style sheet itself.

Apart from the "!important" setting on individual declarations, this strategy gives author's style sheets higher weight than those of the reader. User agents must give the user the ability to turn off the influence of specific author style sheets, e.g., through a pull-down menu. Conformance to UAAG 1.0 checkpoint 4.14 satisfies this condition [UAAG10].

6.4.2 !important rules

CSS attempts to create a balance of power between author and user style sheets. By default, rules in an author's style sheet override those in a user's style sheet (see cascade rule 3).

However, for balance, an "!important" declaration (the delimiter token "!" and keyword "important" follow the declaration) takes precedence over a normal declaration. Both author and user style sheets may contain "!important" declarations, and user "!important" rules override author "!important" rules. This CSS feature improves accessibility of documents by giving users with special requirements (large fonts, color combinations, etc.) control over presentation.

Declaring a shorthand property (e.g., 'background') to be "!important" is equivalent to declaring all of its sub-properties to be "!important".

Example(s):

The first rule in the user's style sheet in the following example contains an "!important" declaration, which overrides the corresponding declaration in the author's style sheet. The second declaration will also win due to being marked "!important". However, the third rule in the user's style sheet is not "!important" and will therefore lose to the second rule in the author's style sheet (which happens to set style on a shorthand property). Also, the third author rule will lose to the second author rule since the second rule is "!important". This shows that "!important" declarations have a function also within author style sheets.

```
/* From the user's style sheet */
p { text-indent: 1em ! important }
p { font-style: italic ! important }
p { font-size: 18pt }

/* From the author's style sheet */
p { text-indent: 1.5em !important }
p { font: normal 12pt sans-serif !important }
p { font-size: 24pt }
```

6.4.3 Calculating a selector's specificity

A selector's specificity is calculated as follows:

- count 1 if the declaration is from is a 'style' attribute rather than a rule with a selector, 0 otherwise (= a) (In HTML, values of an element's "style" attribute are style sheet rules. These rules have no selectors, so a=1, b=0, c=0, and d=0.)
- count the number of ID attributes in the selector (= b)
- count the number of other attributes and pseudo-classes in the selector (= c)
- count the number of element names and pseudo-elements in the selector (= d)

The specificity is based only on the form of the selector. In particular, a selector of the form "[id=p33]" is counted as an attribute selector (a=0, b=0, c=1, d=0), even if the id attribute is defined as an "ID" in the source document's DTD.

Concatenating the four numbers a-b-c-d (in a number system with a large base) gives the specificity.

Example(s):

Some examples:

```
*          {} /* a=0 b=0 c=0 d=0 -> specificity = 0,0,0,0 */
li         {} /* a=0 b=0 c=0 d=1 -> specificity = 0,0,0,1 */
li:first-line {} /* a=0 b=0 c=0 d=2 -> specificity = 0,0,0,2 */
ul li     {} /* a=0 b=0 c=0 d=2 -> specificity = 0,0,0,2 */
ul ol+li  {} /* a=0 b=0 c=0 d=3 -> specificity = 0,0,0,3 */
h1 + *[rel=up] {} /* a=0 b=0 c=1 d=1 -> specificity = 0,0,1,1 */
ul ol li.red {} /* a=0 b=0 c=1 d=3 -> specificity = 0,0,1,3 */
li.red.level {} /* a=0 b=0 c=2 d=1 -> specificity = 0,0,2,1 */
#x34y     {} /* a=0 b=1 c=0 d=0 -> specificity = 0,1,0,0 */
style=""  {} /* a=1 b=0 c=0 d=0 -> specificity = 1,0,0,0 */
```

```
<HEAD>
<STYLE type="text/css">
  #x97z { color: red }
</STYLE>
</HEAD>
<BODY>
<P ID=x97z style="color: green">
</BODY>
```

In the above example, the color of the P element would be green. The declaration in the "style" attribute will override the one in the STYLE element because of cascading rule 3, since it has a higher specificity.

6.4.4 Precedence of non-CSS presentational hints

The UA may choose to honor presentational attributes in an HTML source document. If so, these attributes are translated to the corresponding CSS rules with specificity equal to 0, and are treated as if they were inserted at the start of the author style sheet. They may therefore be overridden by subsequent style sheet rules. In a transition phase, this policy will make it easier for stylistic attributes to

coexist with style sheets.

For HTML, any attribute that is not in the following list should be considered presentational: abbr, accept-charset, accept, accesskey, action, alt, archive, axis, charset, checked, cite, class, classid, code, codebase, codetype, colspan, coords, data, datetime, declare, defer, dir, disabled, enctype, for, headers, href, hreflang, http-equiv, id, ismap, label, lang, language, longdesc, maxlength, media, method, multiple, name, nohref, object, onblur, onchange, onclick, ondblclick, onfocus, onkeydown, onkeypress, onkeyup, onload, onload, onmousedown, onmousemove, onmouseout, onmouseover, onmouseup, onreset, onselect, onsubmit, onunload, onunload, profile, prompt, readonly, rel, rev, rowspan, scheme, scope, selected, shape, span, src, standby, start, style, summary, title, type (except on LI, OL and UL elements), usemap, value, valuetype, version.

For other languages, all document language-based styling must be translated to the corresponding CSS and either enter the cascade at the user agent level or, as with HTML presentational hints, be treated as author level rules with a specificity of zero placed at the start of the author style sheet.

Example(s):

The following user style sheet would override the font weight of 'b' elements in all documents, and the color of 'font' elements with color attributes in XML documents. It would not affect the color of any 'font' elements with color attributes in HTML documents:

```
b { font-weight: normal; }
font[color] { color: orange; }
```

The following, however, would override the color of font elements in all documents:

```
font[color] { color: orange ! important; }
```

7 Media types

Contents

7.1 Introduction to media types	107
7.2 Specifying media-dependent style sheets	107
7.2.1 The @media rule	108
7.3 Recognized media types	108
7.3.1 Media groups	110

7.1 Introduction to media types

One of the most important features of style sheets is that they specify how a document is to be presented on different media: on the screen, on paper, with a speech synthesizer, with a braille device, etc.

Certain CSS properties are only designed for certain media (e.g., the 'page-break-before' property only applies to paged media). On occasion, however, style sheets for different media types may share a property, but require different values for that property. For example, the 'font-size' property is useful both for screen and print media. The two media types are different enough to require different values for the common property; a document will typically need a larger font on a computer screen than on paper. Therefore, it is necessary to express that a style sheet, or a section of a style sheet, applies to certain media types.

7.2 Specifying media-dependent style sheets

There are currently two ways to specify media dependencies for style sheets:

- Specify the target medium from a style sheet with the @media or @import at-rules.

Example(s):

```
@import url("fancyfonts.css") screen;
@media print {
    /* style sheet for print goes here */
}
```

- Specify the target medium within the document language. For example, in HTML 4 ([HTML4]), the "media" attribute on the LINK element specifies the target media of an external style sheet:

```

<!DOCTYPE HTML PUBLIC "-//W3C//DTD HTML 4.01//EN">
<HTML>
  <HEAD>
    <TITLE>Link to a target medium</TITLE>
    <LINK REL="stylesheet" TYPE="text/css"
          MEDIA="print, handheld" HREF="foo.css">
  </HEAD>
  <BODY>
    <P>The body...
  </BODY>
</HTML>

```

The `@import` [p. 102] rule is defined in the chapter on the cascade [p. 99] .

7.2.1 The `@media` rule

An `@media` rule specifies the target media types [p. 108] (separated by commas) of a set of statements [p. 50] (delimited by curly braces). Invalid statements must be ignored per 4.1.7 "Rule sets, declaration blocks, and selectors" [p. 58] and 4.2 "Rules for handling parsing errors." [p. 60] The `@media` construct allows style sheet rules for various media in the same style sheet:

```

@media print {
  body { font-size: 10pt }
}
@media screen {
  body { font-size: 13px }
}
@media screen, print {
  body { line-height: 1.2 }
}

```

Style rules outside of `@media` rules apply to all media types that the style sheet applies to. At-rules inside `@media` are invalid in CSS2.1.

7.3 Recognized media types

The names chosen for CSS media types reflect target devices for which the relevant properties make sense. In the following list of CSS media types the names of media types are normative, but the descriptions are informative. Likewise, the "Media" field in the description of each property is informative.

all

Suitable for all devices.

braille

Intended for braille tactile feedback devices.

embossed

Intended for paged braille printers.

handheld

Intended for handheld devices (typically small screen, limited bandwidth).

print

Intended for paged material and for documents viewed on screen in print preview mode. Please consult the section on paged media [p. 221] for information about formatting issues that are specific to paged media.

projection

Intended for projected presentations, for example projectors. Please consult the section on paged media [p. 221] for information about formatting issues that are specific to paged media.

screen

Intended primarily for color computer screens.

speech

Intended for speech synthesizers. Note: CSS2 had a similar media type called 'aural' for this purpose. See the appendix on aural style sheets [p. 305] for details.

tty

Intended for media using a fixed-pitch character grid (such as teletypes, terminals, or portable devices with limited display capabilities). Authors should not use pixel units [p. ??] with the "tty" media type.

tv

Intended for television-type devices (low resolution, color, limited-scrollability screens, sound available).

Media type names are case-insensitive.

Media types are mutually exclusive in the sense that a user agent can only support one media type when rendering a document. However, user agents may use different media types on different canvases. For example, a document may (simultaneously) be shown in 'screen' mode on one canvas and 'print' mode on another canvas.

Note that a multimodal media type is still only one media type. The 'tv' media type, for example, is a multimodal media type that renders both visually and aurally to a single canvas.

@media and @import rules with unknown media types (that are nonetheless valid identifiers) are treated as if the unknown media types are not present. If an @media/@import rule contains a malformed media type (not an identifier) then the statement is invalid.

Note: *Media Queries supercedes this error handling.*

Example(s):

For example, in the following snippet, the rule on the P element applies in 'screen' mode (even though the '3D' media type is not known).

```
@media screen, 3D {
  P { color: green; }
}
```

Note. Future updates of CSS may extend the list of media types. Authors should not rely on media type names that are not yet defined by a CSS specification.

7.3.1 Media groups

This section is informative, not normative.

Each CSS property definition specifies which media types the property applies to. Since properties generally apply to several media types, the "Applies to media" section of each property definition lists media groups rather than individual media types. Each property applies to all media types in the media groups listed in its definition.

CSS 2.1 defines the following media groups:

- **continuous** or **paged**.
- **visual**, **audio**, **speech**, or **tactile**.
- **grid** (for character grid devices), or **bitmap**.
- **interactive** (for devices that allow user interaction), or **static** (for those that do not).
- **all** (includes all media types)

The following table shows the relationships between media groups and media types:

Relationship between media groups and media types

Media Types	Media Groups			
	continuous/paged	visual/audio/speech/tactile	grid/bitmap	interactive/static
braille	continuous	tactile	grid	both
embossed	paged	tactile	grid	static
handheld	both	visual, audio, speech	both	both
print	paged	visual	bitmap	static
projection	paged	visual	bitmap	interactive
screen	continuous	visual, audio	bitmap	both
speech	continuous	speech	N/A	both
tty	continuous	visual	grid	both
tv	both	visual, audio	bitmap	both

8 Box model

Contents

8.1 Box dimensions	111
8.2 Example of margins, padding, and borders	113
8.3 Margin properties: 'margin-top', 'margin-right', 'margin-bottom', 'margin-left', and 'margin'	115
8.3.1 Collapsing margins	117
8.4 Padding properties: 'padding-top', 'padding-right', 'padding-bottom', 'padding-left', and 'padding'	118
8.5 Border properties	120
8.5.1 Border width: 'border-top-width', 'border-right-width', 'border-bottom-width', 'border-left-width', and 'border-width'	120
8.5.2 Border color: 'border-top-color', 'border-right-color', 'border-bottom-color', 'border-left-color', and 'border-color'	121
8.5.3 Border style: 'border-top-style', 'border-right-style', 'border-bottom-style', 'border-left-style', and 'border-style'	122
8.5.4 Border shorthand properties: 'border-top', 'border-right', 'border-bottom', 'border-left', and 'border'	124
8.6 The box model for inline elements in bidirectional context	126

The CSS box model describes the rectangular boxes that are generated for elements in the document tree [p. 45] and laid out according to the visual formatting model [p. 127] .

8.1 Box dimensions

Each box has a *content area* (e.g., text, an image, etc.) and optional surrounding *padding*, *border*, and *margin* areas; the size of each area is specified by properties defined below. The following diagram shows how these areas relate and the terminology used to refer to pieces of margin, border, and padding:

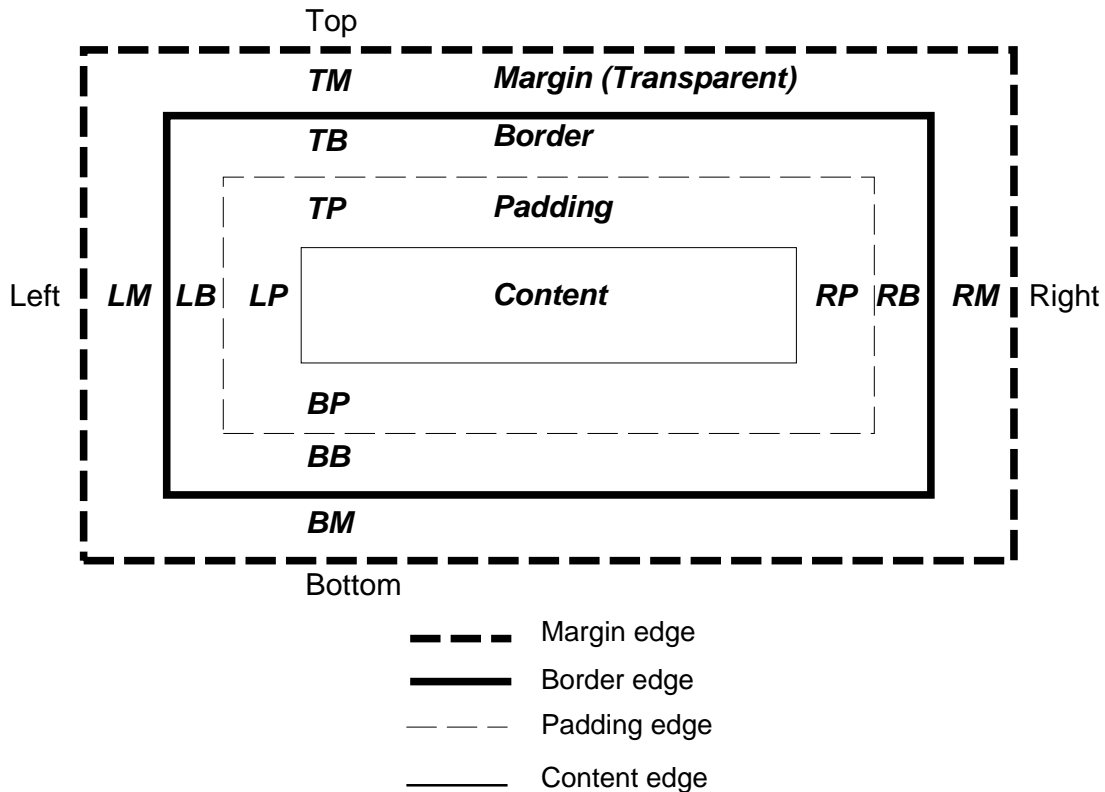

The margin, border, and padding can be broken down into top, right, bottom, and left segments (e.g., in the diagram, "LM" for left margin, "RP" for right padding, "TB" for top border, etc.).

The perimeter of each of the four areas (content, padding, border, and margin) is called an "edge", so each box has four edges:

content edge or inner edge

The content edge surrounds the rectangle given by the width [p. 175] and height [p. 184] of the box, which often depend on the element's rendered content [p. 45]. The four content edges define the box's *content box*.

padding edge

The padding edge surrounds the box padding. If the padding has 0 width, the padding edge is the same as the content edge. The four padding edges define the box's *padding box*.

border edge

The border edge surrounds the box's border. If the border has 0 width, the border edge is the same as the padding edge. The four border edges define the box's *border box*.

margin edge or outer edge

The margin edge surrounds the box margin. If the margin has 0 width, the margin edge is the same as the border edge. The four margin edges define the box's *margin box*.

Each edge may be broken down into a top, right, bottom, and left edge.

The dimensions of the content area of a box — the *content width* and *content height* — depend on several factors: whether the element generating the box has the 'width' or 'height' property set, whether the box contains text or other boxes, whether the box is a table, etc. Box widths and heights are discussed in the chapter on visual formatting model details [p. 171] .

The background style of the content, padding, and border areas of a box is specified by the 'background' property of the generating element. Margin backgrounds are always transparent.

8.2 Example of margins, padding, and borders

This example illustrates how margins, padding, and borders interact. The example HTML document:

```
<!DOCTYPE HTML PUBLIC "-//W3C//DTD HTML 4.01//EN">
<HTML>
  <HEAD>
    <TITLE>Examples of margins, padding, and borders</TITLE>
    <STYLE type="text/css">
      UL {
        background: yellow;
        margin: 12px 12px 12px 12px;
        padding: 3px 3px 3px 3px;
                                          /* No borders set */
      }
      LI {
        color: white;                       /* text color is white */
        background: blue;                   /* Content, padding will be blue */
        margin: 12px 12px 12px 12px;
        padding: 12px 0px 12px 12px; /* Note 0px padding right */
        list-style: none                    /* no glyphs before a list item */
                                          /* No borders set */
      }
      LI.withborder {
        border-style: dashed;
        border-width: medium;               /* sets border width on all sides */
        border-color: lime;
      }
    </STYLE>
  </HEAD>
  <BODY>
    <UL>
      <LI>First element of list
      <LI class="withborder">Second element of list is
          a bit longer to illustrate wrapping.
    </UL>
  </BODY>
</HTML>
```

results in a document tree [p. 45] with (among other relationships) a UL element that has two LI children.

The first of the following diagrams illustrates what this example would produce. The second illustrates the relationship between the margins, padding, and borders of the UL elements and those of its children LI elements. (Image is not to scale.)

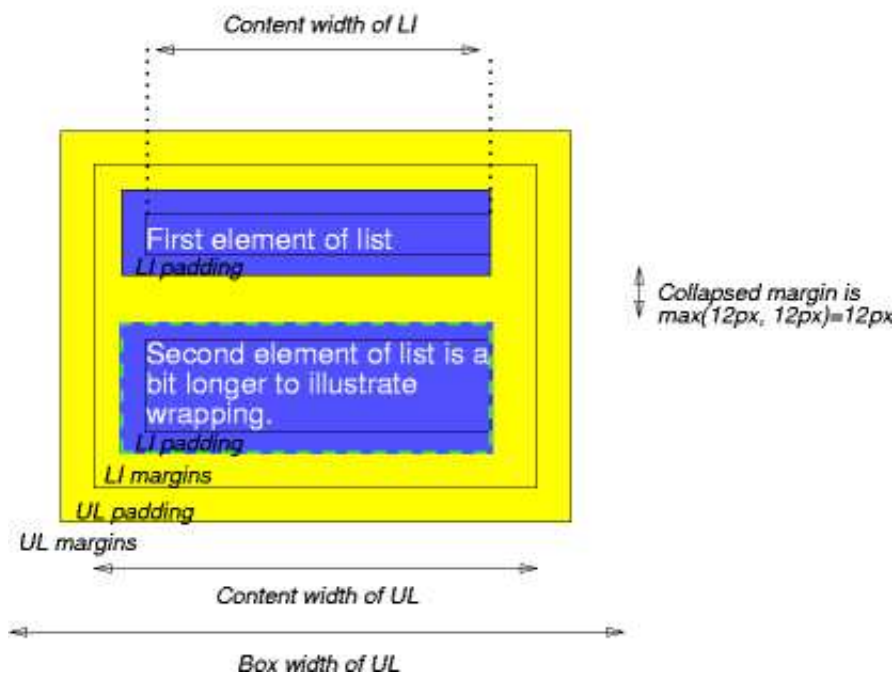

Note that:

- The content width [p. 113] for each LI box is calculated top-down; the containing block [p. 128] for each LI box is established by the UL element.
- The margin box height of each LI box depends on its content height [p. 113] ,

plus top and bottom padding, borders, and margins. Note that vertical margins between the LI boxes collapse. [p. 117]

- The right padding of the LI boxes has been set to zero width (the 'padding' property). The effect is apparent in the second illustration.
- The margins of the LI boxes are transparent — margins are always transparent — so the background color (yellow) of the UL padding and content areas shines through them.
- The second LI element specifies a dashed border (the 'border-style' property).

8.3 Margin properties: 'margin-top', 'margin-right', 'margin-bottom', 'margin-left', and 'margin'

Margin properties specify the width of the margin area [p. 111] of a box. The 'margin' shorthand property sets the margin for all four sides while the other margin properties only set their respective side. These properties apply to all elements, but vertical margins will not have any effect on non-replaced inline elements.

The properties defined in this section refer to the **<margin-width>** value type, which may take one of the following values:

<length>

Specifies a fixed width.

<percentage>

The percentage is calculated with respect to the *width* of the generated box's containing block [p. 128]. Note that this is true for 'margin-top' and 'margin-bottom' as well. If the containing block's width depends on this element, then the resulting layout is undefined in CSS 2.1.

auto

See the section on calculating widths and margins [p. 175] for behavior.

Negative values for margin properties are allowed, but there may be implementation-specific limits.

'margin-top', 'margin-bottom'

<i>Value:</i>	<margin-width> inherit
<i>Initial:</i>	0
<i>Applies to:</i>	all elements except elements with table display types other than table-caption, table and inline-table
<i>Inherited:</i>	no
<i>Percentages:</i>	refer to width of containing block
<i>Media:</i>	visual
<i>Computed value:</i>	the percentage as specified or the absolute length

These properties have no effect on non-replaced inline elements.

'margin-right', 'margin-left'

<i>Value:</i>	<margin-width> inherit
<i>Initial:</i>	0
<i>Applies to:</i>	all elements except elements with table display types other than table-caption, table and inline-table
<i>Inherited:</i>	no
<i>Percentages:</i>	refer to width of containing block
<i>Media:</i>	visual
<i>Computed value:</i>	the percentage as specified or the absolute length

These properties set the top, right, bottom, and left margin of a box.

Example(s):

```
h1 { margin-top: 2em }
```

'margin'

<i>Value:</i>	<margin-width>{1,4} inherit
<i>Initial:</i>	see individual properties
<i>Applies to:</i>	all elements except elements with table display types other than table-caption, table and inline-table
<i>Inherited:</i>	no
<i>Percentages:</i>	refer to width of containing block
<i>Media:</i>	visual
<i>Computed value:</i>	see individual properties

The 'margin' property is a shorthand property for setting 'margin-top', 'margin-right', 'margin-bottom', and 'margin-left' at the same place in the style sheet.

If there is only one component value, it applies to all sides. If there are two values, the top and bottom margins are set to the first value and the right and left margins are set to the second. If there are three values, the top is set to the first value, the left and right are set to the second, and the bottom is set to the third. If there are four values, they apply to the top, right, bottom, and left, respectively.

Example(s):

```
body { margin: 2em }           /* all margins set to 2em */
body { margin: 1em 2em }      /* top & bottom = 1em, right & left = 2em */
body { margin: 1em 2em 3em }  /* top=1em, right=2em, bottom=3em, left=2em */
```

The last rule of the example above is equivalent to the example below:

```
body {
  margin-top: 1em;
  margin-right: 2em;
  margin-bottom: 3em;
  margin-left: 2em;          /* copied from opposite side (right) */
}
```

8.3.1 Collapsing margins

In this specification, the expression *collapsing margins* means that adjoining margins (no non-empty content, padding or border areas or clearance [p. 150] separate them) of two or more boxes (which may be next to one another or nested) combine to form a single margin.

In CSS 2.1, horizontal margins never collapse.

Vertical margins may collapse between certain boxes:

- Two or more adjoining vertical margins of block-level [p. ??] boxes in the normal flow [p. 138] collapse. The resulting margin width is the maximum of the adjoining margin widths. In the case of negative margins, the maximum of the absolute values of the negative adjoining margins is deducted from the maximum of the positive adjoining margins. If there are no positive margins, the absolute maximum of the negative adjoining margins is deducted from zero. **Note.** Adjoining boxes may be generated by elements that are not related as siblings or ancestors.
- Vertical margins between a floated [p. 143] box and any other box do not collapse (not even between a float and its in-flow children).
- Vertical margins of elements that establish new block formatting contexts (such as floats and elements with 'overflow' other than 'visible') do not collapse with their in-flow children.
- Margins of absolutely [p. 152] positioned boxes do not collapse (not even with their in-flow children).
- Margins of inline-block elements do not collapse (not even with their in-flow children).
- If the top and bottom margins of a box are adjoining, then it is possible for margins to collapse through it. In this case, the position of the element depends on its relationship with the other elements whose margins are being collapsed.
 - If the element's margins are collapsed with its parent's top margin, the top border edge of the box is defined to be the same as the parent's.
 - Otherwise, either the element's parent is not taking part in the margin collapsing, or only the parent's bottom margin is involved. The position of the element's top border edge is the same as it would have been if the element had a non-zero bottom border.

An element that has clearance [p. 150] never collapses its top margin with its parent block's bottom margin.

Note that the positions of elements that have been collapsed through have no effect on the positions of the other elements with whose margins they are being collapsed; the top border edge position is only required for laying out descendants of these elements.

- Margins of the root element's box do not collapse.

The bottom margin of an in-flow block-level element is always adjoining to the top margin of its next in-flow block-level sibling, unless that sibling has clearance. [p. 150]

The top margin of an in-flow block box is adjoining to its first in-flow block-level child's top margin if the element has no top border, no top padding, and the child has no clearance. [p. 150]

The bottom margin of an in-flow block box with a 'height' of 'auto' is adjoining to its last in-flow block-level child's bottom margin if the element has no bottom padding or border.

An element's own margins are adjoining if the 'min-height' property is zero, and it has neither top or bottom borders nor top or bottom padding, and it has a 'height' of either 0 or 'auto', and it does not contain a line box, and all of its in-flow children's margins (if any) are adjoining.

When an element's own margins collapse, and that element has clearance, its top margin collapses with the adjoining margins of subsequent siblings but that resulting margin does not collapse with the bottom margin of the parent block.

Collapsing is based on the *used value* of 'padding', 'margin', and 'border' (i.e., after resolving any percentages). The collapsed margin is calculated over the used value of the various margins.

Please consult the examples of margin, padding, and borders [p. 113] for an illustration of collapsed margins.

8.4 Padding properties: 'padding-top', 'padding-right', 'padding-bottom', 'padding-left', and 'padding'

The padding properties specify the width of the padding area [p. 111] of a box. The 'padding' shorthand property sets the padding for all four sides while the other padding properties only set their respective side.

The properties defined in this section refer to the **<padding-width>** value type, which may take one of the following values:

<length>

Specifies a fixed width.

<percentage>

The percentage is calculated with respect to the *width* of the generated box's containing block [p. 128], even for 'padding-top' and 'padding-bottom'. If the containing block's width depends on this element, then the resulting layout is

undefined in CSS 2.1.

Unlike margin properties, values for padding values cannot be negative. Like margin properties, percentage values for padding properties refer to the width of the generated box's containing block.

'padding-top', 'padding-right', 'padding-bottom', 'padding-left'

<i>Value:</i>	<padding-width> inherit
<i>Initial:</i>	0
<i>Applies to:</i>	all elements except table-row-group, table-header-group, table-footer-group, table-row, table-column-group and table-column
<i>Inherited:</i>	no
<i>Percentages:</i>	refer to width of containing block
<i>Media:</i>	visual
<i>Computed value:</i>	the percentage as specified or the absolute length

These properties set the top, right, bottom, and left padding of a box.

Example(s):

```
blockquote { padding-top: 0.3em }
```

'padding'

<i>Value:</i>	<padding-width>{1,4} inherit
<i>Initial:</i>	see individual properties
<i>Applies to:</i>	all elements except table-row-group, table-header-group, table-footer-group, table-row, table-column-group and table-column
<i>Inherited:</i>	no
<i>Percentages:</i>	refer to width of containing block
<i>Media:</i>	visual
<i>Computed value:</i>	see individual properties

The 'padding' property is a shorthand property for setting 'padding-top', 'padding-right', 'padding-bottom', and 'padding-left' at the same place in the style sheet.

If there is only one component value, it applies to all sides. If there are two values, the top and bottom paddings are set to the first value and the right and left paddings are set to the second. If there are three values, the top is set to the first value, the left and right are set to the second, and the bottom is set to the third. If there are four values, they apply to the top, right, bottom, and left, respectively.

The surface color or image of the padding area is specified via the 'background' property:

Example(s):

```
h1 {
  background: white;
  padding: 1em 2em;
}
```

The example above specifies a '1em' vertical padding ('padding-top' and 'padding-bottom') and a '2em' horizontal padding ('padding-right' and 'padding-left'). The 'em' unit is relative [p. 63] to the element's font size: '1em' is equal to the size of the font in use.

8.5 Border properties

The border properties specify the width, color, and style of the border area [p. 111] of a box. These properties apply to all elements.

Note. *Notably for HTML, user agents may render borders for certain user interface elements (e.g., buttons, menus, etc.) differently than for "ordinary" elements.*

8.5.1 Border width: 'border-top-width', 'border-right-width', 'border-bottom-width', 'border-left-width', and 'border-width'

The border width properties specify the width of the border area [p. 111]. The properties defined in this section refer to the **<border-width>** value type, which may take one of the following values:

thin

A thin border.

medium

A medium border.

thick

A thick border.

<length>

The border's thickness has an explicit value. Explicit border widths cannot be negative.

The interpretation of the first three values depends on the user agent. The following relationships must hold, however:

'thin' <='medium' <='thick'.

Furthermore, these widths must be constant throughout a document.

'border-top-width', 'border-right-width', 'border-bottom-width', 'border-left-width'

<i>Value:</i>	<border-width> inherit
<i>Initial:</i>	medium
<i>Applies to:</i>	all elements
<i>Inherited:</i>	no
<i>Percentages:</i>	N/A
<i>Media:</i>	visual
<i>Computed value:</i>	absolute length; '0' if the border style is 'none' or 'hidden'

These properties set the width of the top, right, bottom, and left border of a box.

'border-width'

<i>Value:</i>	<border-width>{1,4} inherit
<i>Initial:</i>	see individual properties
<i>Applies to:</i>	all elements
<i>Inherited:</i>	no
<i>Percentages:</i>	N/A
<i>Media:</i>	visual
<i>Computed value:</i>	see individual properties

This property is a shorthand property for setting 'border-top-width', 'border-right-width', 'border-bottom-width', and 'border-left-width' at the same place in the style sheet.

If there is only one component value, it applies to all sides. If there are two values, the top and bottom borders are set to the first value and the right and left are set to the second. If there are three values, the top is set to the first value, the left and right are set to the second, and the bottom is set to the third. If there are four values, they apply to the top, right, bottom, and left, respectively.

Example(s):

In the examples below, the comments indicate the resulting widths of the top, right, bottom, and left borders:

```
h1 { border-width: thin }           /* thin thin thin thin */
h1 { border-width: thin thick }    /* thin thick thin thick */
h1 { border-width: thin thick medium } /* thin thick medium thick */
```

8.5.2 Border color: 'border-top-color', 'border-right-color', 'border-bottom-color', 'border-left-color', and 'border-color'

The border color properties specify the color of a box's border.

'border-top-color', 'border-right-color', 'border-bottom-color', 'border-left-color'

<i>Value:</i>	<color> transparent inherit
<i>Initial:</i>	the value of the 'color' property
<i>Applies to:</i>	all elements
<i>Inherited:</i>	no
<i>Percentages:</i>	N/A
<i>Media:</i>	visual
<i>Computed value:</i>	when taken from the 'color' property, the computed value of 'color'; otherwise, as specified

'border-color'

<i>Value:</i>	[<color> transparent]{1,4} inherit
<i>Initial:</i>	see individual properties
<i>Applies to:</i>	all elements
<i>Inherited:</i>	no
<i>Percentages:</i>	N/A
<i>Media:</i>	visual
<i>Computed value:</i>	see individual properties

The 'border-color' property sets the color of the four borders. Values have the following meanings:

<color>

Specifies a color value.

transparent

The border is transparent (though it may have width).

The 'border-color' property can have from one to four component values, and the values are set on the different sides as for 'border-width'.

If an element's border color is not specified with a border property, user agents must use the value of the element's 'color' property as the computed value [p. 100] for the border color.

Example(s):

In this example, the border will be a solid black line.

```
p {
  color: black;
  background: white;
  border: solid;
}
```

8.5.3 Border style: 'border-top-style', 'border-right-style', 'border-bottom-style', 'border-left-style', and 'border-style'

The border style properties specify the line style of a box's border (solid, double, dashed, etc.). The properties defined in this section refer to the **<border-style>** value type, which may take one of the following values:

none

No border; the computed border width is zero.

hidden

Same as 'none', except in terms of border conflict resolution [p. 292] for table elements [p. 269] .

dotted

The border is a series of dots.

dashed

The border is a series of short line segments.

solid

The border is a single line segment.

double

The border is two solid lines. The sum of the two lines and the space between them equals the value of 'border-width'.

groove

The border looks as though it were carved into the canvas.

ridge

The opposite of 'groove': the border looks as though it were coming out of the canvas.

inset

The border makes the box look as though it were embedded in the canvas.

outset

The opposite of 'inset': the border makes the box look as though it were coming out of the canvas.

All borders are drawn on top of the box's background. The color of borders drawn for values of 'groove', 'ridge', 'inset', and 'outset' depends on the element's border color properties [p. 121] , but UAs may choose their own algorithm to calculate the actual colors used. For instance, if the 'border-color' has the value 'silver', then a UA could use a gradient of colors from white to dark gray to indicate a sloping border.

'border-top-style', 'border-right-style', 'border-bottom-style', 'border-left-style'

Value: <border-style> | inherit
Initial: none
Applies to: all elements
Inherited: no
Percentages: N/A
Media: visual
Computed value: as specified

'border-style'

<i>Value:</i>	<border-style>{1,4} inherit
<i>Initial:</i>	see individual properties
<i>Applies to:</i>	all elements
<i>Inherited:</i>	no
<i>Percentages:</i>	N/A
<i>Media:</i>	visual
<i>Computed value:</i>	see individual properties

The 'border-style' property sets the style of the four borders. It can have from one to four component values, and the values are set on the different sides as for 'border-width' above.

Example(s):

```
#xy34 { border-style: solid dotted }
```

In the above example, the horizontal borders will be 'solid' and the vertical borders will be 'dotted'.

Since the initial value of the border styles is 'none', no borders will be visible unless the border style is set.

8.5.4 Border shorthand properties: 'border-top', 'border-right', 'border-bottom', 'border-left', and 'border'

'border-top', 'border-right', 'border-bottom', 'border-left'

<i>Value:</i>	[<border-width> <border-style> <'border-top-color'>] inherit
<i>Initial:</i>	see individual properties
<i>Applies to:</i>	all elements
<i>Inherited:</i>	no
<i>Percentages:</i>	N/A
<i>Media:</i>	visual
<i>Computed value:</i>	see individual properties

This is a shorthand property for setting the width, style, and color of the top, right, bottom, and left border of a box.

Example(s):

```
h1 { border-bottom: thick solid red }
```

The above rule will set the width, style, and color of the border **below** the H1 element. Omitted values are set to their initial values [p. 31] . Since the following rule does not specify a border color, the border will have the color specified by the 'color' property:

```
H1 { border-bottom: thick solid }
```

'border'

Value: [<border-width> || <border-style> || <'border-top-color'>] | inherit

Initial: see individual properties

Applies to: all elements

Inherited: no

Percentages: N/A

Media: visual

Computed value: see individual properties

The 'border' property is a shorthand property for setting the same width, color, and style for all four borders of a box. Unlike the shorthand 'margin' and 'padding' properties, the 'border' property cannot set different values on the four borders. To do so, one or more of the other border properties must be used.

Example(s):

For example, the first rule below is equivalent to the set of four rules shown after it:

```
p { border: solid red }
p {
  border-top: solid red;
  border-right: solid red;
  border-bottom: solid red;
  border-left: solid red
}
```

Since, to some extent, the properties have overlapping functionality, the order in which the rules are specified is important.

Example(s):

Consider this example:

```
blockquote {
  border: solid red;
  border-left: double;
  color: black;
}
```

In the above example, the color of the left border is black, while the other borders are red. This is due to 'border-left' setting the width, style, and color. Since the color value is not given by the 'border-left' property, it will be taken from the 'color' property. The fact that the 'color' property is set after the 'border-left' property is not relevant.

8.6 The box model for inline elements in bidirectional context

For each line box, UAs must take the inline boxes generated for each element and render the margins, borders and padding in visual order (not logical order).

When the element's 'direction' property is 'ltr', the left-most generated box of the first line box in which the element appears has the left margin, left border and left padding, and the right-most generated box of the last line box in which the element appears has the right padding, right border and right margin.

When the element's 'direction' property is 'rtl', the right-most generated box of the first line box in which the element appears has the right padding, right border and right margin, and the left-most generated box of the last line box in which the element appears has the left margin, left border and left padding.

9 Visual formatting model

Contents

9.1 Introduction to the visual formatting model	127
9.1.1 The viewport	128
9.1.2 Containing blocks	128
9.2 Controlling box generation	129
9.2.1 Block-level elements and block boxes	129
9.2.1.1 Anonymous block boxes	129
9.2.2 Inline-level elements and inline boxes	131
9.2.2.1 Anonymous inline boxes	132
9.2.3 Run-in boxes	132
9.2.4 The 'display' property	133
9.3 Positioning schemes	135
9.3.1 Choosing a positioning scheme: 'position' property	135
9.3.2 Box offsets: 'top', 'right', 'bottom', 'left'	136
9.4 Normal flow	138
9.4.1 Block formatting contexts	139
9.4.2 Inline formatting contexts	139
9.4.3 Relative positioning	142
9.5 Floats	143
9.5.1 Positioning the float: the 'float' property	147
9.5.2 Controlling flow next to floats: the 'clear' property	149
9.6 Absolute positioning	152
9.6.1 Fixed positioning	152
9.7 Relationships between 'display', 'position', and 'float'	154
9.8 Comparison of normal flow, floats, and absolute positioning	155
9.8.1 Normal flow	155
9.8.2 Relative positioning	156
9.8.3 Floating a box	157
9.8.4 Absolute positioning	160
9.9 Layered presentation	164
9.9.1 Specifying the stack level: the 'z-index' property	164
9.10 Text direction: the 'direction' and 'unicode-bidi' properties	166

9.1 Introduction to the visual formatting model

This chapter and the next describe the visual formatting model: how user agents process the document tree [p. 45] for visual media [p. 107] .

In the visual formatting model, each element in the document tree generates zero or more boxes according to the box model [p. 111] . The layout of these boxes is governed by:

- box dimensions [p. 111] and type [p. 129] .
- positioning scheme [p. 135] (normal flow, float, and absolute positioning).
- relationships between elements in the document tree. [p. 45]
- external information (e.g., viewport size, intrinsic [p. 45] dimensions of images, etc.).

The properties defined in this chapter and the next apply to both continuous media [p. 110] and paged media [p. 110] . However, the meanings of the margin properties [p. 115] vary when applied to paged media (see the page model [p. 222] for details).

The visual formatting model does not specify all aspects of formatting (e.g., it does not specify a letter-spacing algorithm). Conforming user agents [p. 47] may behave differently for those formatting issues not covered by this specification.

9.1.1 The viewport

User agents for continuous media [p. 110] generally offer users a *viewport* (a window or other viewing area on the screen) through which users consult a document. User agents may change the document's layout when the viewport is resized (see the initial containing block [p. 171]).

When the viewport is smaller than the area of the canvas on which the document is rendered, the user agent should offer a scrolling mechanism. There is at most one viewport per canvas [p. 40] , but user agents may render to more than one canvas (i.e., provide different views of the same document).

9.1.2 Containing blocks

In CSS 2.1, many box positions and sizes are calculated with respect to the edges of a rectangular box called a *containing block*. In general, generated boxes act as containing blocks for descendant boxes; we say that a box "establishes" the containing block for its descendants. The phrase "a box's containing block" means "the containing block in which the box lives," not the one it generates.

Each box is given a position with respect to its containing block, but it is not confined by this containing block; it may overflow [p. 195] .

The details [p. 171] of how a containing block's dimensions are calculated are described in the next chapter [p. 171] .

9.2 Controlling box generation

The following sections describe the types of boxes that may be generated in CSS 2.1. A box's type affects, in part, its behavior in the visual formatting model. The 'display' property, described below, specifies a box's type.

9.2.1 Block-level elements and block boxes

Block-level elements are those elements of the source document that are formatted visually as blocks (e.g., paragraphs). The following values of the 'display' property make an element block-level: 'block', 'list-item', and 'run-in' (part of the time; see run-in boxes [p. 132]), and 'table'.

Block-level boxes are boxes that participate in a block formatting context. [p. 139] Each block-level element generates a *principal block-level box* that contains descendant boxes and generated content and is also the box involved in any positioning scheme. Some block-level elements may generate additional boxes in addition to the principal box: 'list-item' elements. These additional boxes are placed with respect to the principal box.

Except for table boxes, which are described in a later chapter, and replaced elements, a block-level box is also a block container box. A *block container box* either contains only block-level boxes or establishes an inline formatting context and thus contains only inline-level boxes. Not all block container boxes are block-level elements: non-replaced inline blocks and non-replaced table cells are block containers but not block-level boxes. Block-level boxes that are also block containers are called *block boxes*.

The three terms "block-level box," "block container box," and "block box" are sometimes abbreviated as "block" where unambiguous.

9.2.1.1 Anonymous block boxes

In a document like this:

```
<DIV>
  Some text
  <P>More text
</DIV>
```

(and assuming the DIV and the P both have 'display: block'), the DIV appears to have both inline content and block content. To make it easier to define the formatting, we assume that there is an *anonymous block box* around "Some text".

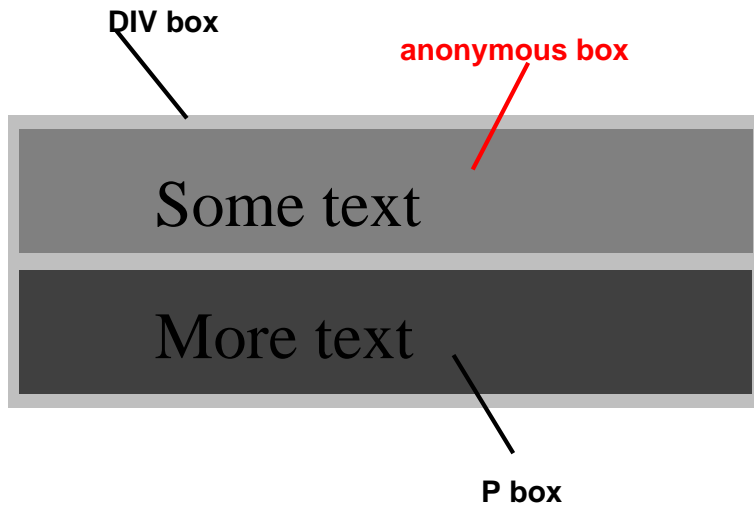

Diagram showing the three boxes, of which one is anonymous, for the example above.

In other words: if a block container box (such as that generated for the DIV above) has a block-level box inside it (such as the P above), then we force it to have *only* block-level boxes inside it.

When an inline box contains an in-flow block-level box, the inline box (and its inline ancestors within the same line box) are broken around the block-level box, dividing the inline box into two pieces even if either side is empty. The line boxes before the break and after the break are enclosed in anonymous block boxes, and the block-level box becomes a sibling of those anonymous boxes. When such an inline box is affected by relative positioning, the relative positioning also affects the block-level box contained in the inline box.

Example(s):

This model would apply in the following example if the following rules:

```
p { display: inline }
span { display: block }
```

were used with this HTML document:

```
<!DOCTYPE HTML PUBLIC "-//W3C//DTD HTML 4.01//EN">
<HEAD>
<TITLE>Anonymous text interrupted by a block</TITLE>
</HEAD>
<BODY>
<P>
This is anonymous text before the SPAN.
<SPAN>This is the content of SPAN.</SPAN>
This is anonymous text after the SPAN.
</P>
</BODY>
```

The P element contains a chunk (C1) of anonymous text followed by a block-level element followed by another chunk (C2) of anonymous text. The resulting boxes would be an anonymous block box around the P, containing an anonymous block box around C1, the SPAN block box, and another anonymous block box around C2.

The properties of anonymous boxes are inherited from the enclosing non-anonymous box (e.g., in the example just below the subsection heading "Anonymous block boxes", the one for DIV). Non-inherited properties have their initial value. For example, the font of the anonymous box is inherited from the DIV, but the margins will be 0.

Properties set on elements that cause anonymous block boxes to be generated still apply to the boxes and content of that element. For example, if a border had been set on the P element in the above example, the border would be drawn around C1 (open at the end of the line) and C2 (open at the start of the line).

Some user agents have implemented borders on inlines containing blocks in other ways, e.g., by wrapping such nested blocks inside "anonymous line boxes" and thus drawing inline borders around such boxes. As CSS1 and CSS2 did not define this behavior, CSS1-only and CSS2-only user agents may implement this alternative model and still claim conformance to this part of CSS 2.1. This does not apply to UAs developed after this specification was released.

Anonymous block boxes are ignored when resolving percentage values that would refer to it: the closest non-anonymous ancestor box is used instead. For example, if the child of the anonymous block box inside the DIV above needs to know the height of its containing block to resolve a percentage height, then it will use the height of the containing block formed by the DIV, not of the anonymous block box.

9.2.2 Inline-level elements and inline boxes

Inline-level elements are those elements of the source document that do not form new blocks of content; the content is distributed in lines (e.g., emphasized pieces of text within a paragraph, inline images, etc.). The following values of the 'display' property make an element inline-level: 'inline', 'inline-table', 'inline-block' and 'run-in' (part of the time; see run-in boxes [p. 132]). Inline-level elements generate *inline-level boxes*, which are boxes that participate in an inline formatting context.

An *inline box* is one that is both inline-level and whose contents participate in its containing inline formatting context. A non-replaced element with a 'display' value of 'inline' generates an inline box. An element with a 'display' value of 'run-in' can also generate an inline box; see run-in boxes. [p. 132] Inline-level boxes that are not inline boxes (such as replaced inline-level elements, inline-block elements, and inline-table elements) are called *atomic inline-level boxes* because they participate in their inline formatting context as a single opaque box.

9.2.2.1 Anonymous inline boxes

Any text that is directly contained inside a block container element (not inside an inline element) must be treated as an anonymous inline element.

In a document with HTML markup like this:

```
<p>Some <em>emphasized</em> text</p>
```

the `<p>` generates a block box, with several inline boxes inside it. The box for "emphasized" is an inline box generated by an inline element (``), but the other boxes ("Some" and "text") are inline boxes generated by a block-level element (`<p>`). The latter are called anonymous inline boxes, because they do not have an associated inline-level element.

Such anonymous inline boxes inherit inheritable properties from their block parent box. Non-inherited properties have their initial value. In the example, the color of the anonymous inline boxes is inherited from the P, but the background is transparent.

White space content that would subsequently be collapsed away according to the 'white-space' property does not generate any anonymous inline boxes.

If it is clear from the context which type of anonymous box is meant, both anonymous inline boxes and anonymous block boxes are simply called anonymous boxes in this specification.

There are more types of anonymous boxes that arise when formatting tables [p. 273].

9.2.3 Run-in boxes

A *run-in element* (or pseudo-element) *A* behaves as follows:

1. If *A* has any children [p. 45] that inhibit run-in behavior [p. 132] (see below), then *A* is rendered as if it had 'display: block'.
2. Let *B* be the first of *A*'s following siblings [p. 46] that is neither floating nor absolutely positioned [p. 152] nor has 'display: none'. If *B* exists and has a specified value for 'display' of 'block' or 'list-item' and is not replaced, [p. 44] then *A* is rendered as an 'inline' element at the start of *B*'s principal box. [p. 129] Note: *A* is rendered before *B*'s ':before' pseudo-element, if any. See 12.1. [p. 203]
3. Otherwise, *A* is rendered as if it had 'display: block'.

In the above, "siblings" and "children" include both normal elements and :before/:after pseudo-elements.

An element or pseudo-element *C* *inhibits run-in behavior* if one of the following is true. (Note that the definition is recursive.)

1. *C* is not floating and not absolutely positioned [p. 152] and the computed value of its 'display' is one of 'block', 'list-item', 'table' or 'run-in'.
2. *C* has a computed value for 'display' of 'inline' and it has one or more children that inhibit run-in behavior. (Where "children" includes both normal elements

and :before/:after pseudo-elements.)

A 'run-in' box is useful for run-in headers, as in this example:

```
<!DOCTYPE HTML PUBLIC "-//W3C//DTD HTML 4.01//EN">
<HTML>
  <HEAD>
    <TITLE>A run-in box example</TITLE>
    <STYLE type="text/css">
      H3 { display: run-in }
    </STYLE>
  </HEAD>
  <BODY>
    <H3>A run-in heading.</H3>
    <P>And a paragraph of text that
      follows it.
    </BODY>
</HTML>
```

This example might be formatted as:

A run-in heading. And a paragraph of text that follows it.

Despite appearing visually part of the following block box, a run-in element still inherits properties from its parent in the source tree. It is undefined in CSS 2.1 if a run-in inherits from a ':first-line' pseudo-element.

Please consult the section on generated content [p. 203] for information about how run-in boxes interact with generated content.

9.2.4 The 'display' property

'display'

<i>Value:</i>	inline block list-item run-in inline-block table inline-table table-row-group table-header-group table-footer-group table-row table-column-group table-column table-cell table-caption none inherit
<i>Initial:</i>	inline
<i>Applies to:</i>	all elements
<i>Inherited:</i>	no
<i>Percentages:</i>	N/A
<i>Media:</i>	all
<i>Computed value:</i>	see text

The values of this property have the following meanings:

block

This value causes an element to generate a block box.

inline-block

This value causes an element to generate an inline-level block container. The inside of an inline-block is formatted as a block box, and the element itself is formatted as an atomic inline-level box.

inline

This value causes an element to generate one or more inline boxes.

list-item

This value causes an element (e.g., LI in HTML) to generate a principal block box and a marker box. For information about lists and examples of list formatting, please consult the section on lists [p. 214] .

none

This value causes an element to not appear in the formatting structure [p. 40] (i.e., in visual media the element generates no boxes and has no effect on layout). Descendant elements do not generate any boxes either; the element and its content are removed from the formatting structure entirely. This behavior **cannot** be overridden by setting the 'display' property on the descendants.

Please note that a display of 'none' does not create an invisible box; it creates no box at all. CSS includes mechanisms that enable an element to generate boxes in the formatting structure that affect formatting but are not visible themselves. Please consult the section on visibility [p. 201] for details.

run-in

This value creates either block or inline boxes, depending on context. Properties apply to run-in boxes based on their final status (inline-level or block-level).

table, inline-table, table-row-group, table-column, table-column-group, table-header-group, table-footer-group, table-row, table-cell, and table-caption

These values cause an element to behave like a table element (subject to restrictions described in the chapter on tables [p. 269]).

The computed value is the same as the specified value, except for positioned and floating elements (see Relationships between 'display', 'position', and 'float' [p. 154]) and for the root element. For the root element, the computed value is changed as described in the section on the relationships between 'display', 'position', and 'float' [p. 154] .

Note that although the initial value [p. 31] of 'display' is 'inline', rules in the user agent's default style sheet [p. 103] may override [p. 99] this value. See the sample style sheet [p. 435] for HTML 4 in the appendix.

Example(s):

Here are some examples of the 'display' property:

```
p { display: block }
em { display: inline }
li { display: list-item }
img { display: none } /* Do not display images */
```

9.3 Positioning schemes

In CSS 2.1, a box may be laid out according to three *positioning schemes*:

1. Normal flow [p. 138] . In CSS 2.1, normal flow includes block formatting [p. 139] of block-level boxes, inline formatting [p. 139] of inline-level boxes, relative positioning [p. 142] of block-level and inline-level boxes, and formatting of run-in [p. 132] boxes.
2. Floats [p. 143] . In the float model, a box is first laid out according to the normal flow, then taken out of the flow and shifted to the left or right as far as possible. Content may flow along the side of a float.
3. Absolute positioning [p. 152] . In the absolute positioning model, a box is removed from the normal flow entirely (it has no impact on later siblings) and assigned a position with respect to a containing block.

Note. *CSS 2.1's positioning schemes help authors make their documents more accessible by allowing them to avoid mark-up tricks (e.g., invisible images) used for layout effects.*

9.3.1 Choosing a positioning scheme: 'position' property

The 'position' and 'float' properties determine which of the CSS 2.1 positioning algorithms is used to calculate the position of a box.

'position'

<i>Value:</i>	static relative absolute fixed inherit
<i>Initial:</i>	static
<i>Applies to:</i>	all elements
<i>Inherited:</i>	no
<i>Percentages:</i>	N/A
<i>Media:</i>	visual
<i>Computed value:</i>	as specified

The values of this property have the following meanings:

static

The box is a normal box, laid out according to the normal flow [p. 138] . The 'top', 'right', 'bottom', and 'left' properties do not apply.

relative

The box's position is calculated according to the normal flow [p. 138] (this is called the position in normal flow). Then the box is offset relative [p. 142] to its normal position. When a box B is relatively positioned, the position of the following box is calculated as though B were not offset. The effect of 'position:relative' on table-row-group, table-header-group, table-footer-group, table-row, table-column-group, table-column, table-cell, and table-caption elements is undefined.

absolute

The box's position (and possibly size) is specified with the 'top', 'right', 'bottom', and 'left' properties. These properties specify offsets with respect to the box's containing block [p. 128] . Absolutely positioned boxes are taken out of the normal flow. This means they have no impact on the layout of later siblings. Also, though absolutely positioned [p. 152] boxes have margins, they do not collapse [p. 117] with any other margins.

fixed

The box's position is calculated according to the 'absolute' model, but in addition, the box is fixed [p. 152] with respect to some reference. As with the 'absolute' model, the box's margins do not collapse with any other margins. In the case of handheld, projection, screen, tty, and tv media types, the box is fixed with respect to the viewport [p. 128] and does not move when scrolled. In the case of the print media type, the box is rendered on every page, and is fixed with respect to the page box, even if the page is seen through a viewport [p. 128] (in the case of a print-preview, for example). For other media types, the presentation is undefined. Authors may wish to specify 'fixed' in a media-dependent way. For instance, an author may want a box to remain at the top of the viewport [p. 128] on the screen, but not at the top of each printed page. The two specifications may be separated by using an @media rule [p. 108] , as in:

Example(s):

```
@media screen {
  h1#first { position: fixed }
}
@media print {
  h1#first { position: static }
}
```

UAs must not paginate the content of fixed boxes. Note that UAs may print invisible content in other ways. See "Content outside the page box" [p. 225] in chapter 13.

User agents may treat position as 'static' on the root element.

9.3.2 Box offsets: 'top', 'right', 'bottom', 'left'

An element is said to be *positioned* if its 'position' property has a value other than 'static'. Positioned elements generate positioned boxes, laid out according to four properties:

'top'

Value: <length> | <percentage> | auto | inherit
Initial: auto
Applies to: positioned elements
Inherited: no
Percentages: refer to height of containing block
Media: visual
Computed value: for 'position:static', 'auto'. Otherwise: if specified as a length, the corresponding absolute length; if specified as a percentage, the specified value; otherwise, 'auto'.

This property specifies how far an absolutely positioned [p. 152] box's top margin edge is offset below the top edge of the box's containing block [p. 128] . For relatively positioned boxes, the offset is with respect to the top edges of the box itself (i.e., the box is given a position in the normal flow, then offset from that position according to these properties).

'right'

Value: <length> | <percentage> | auto | inherit
Initial: auto
Applies to: positioned elements
Inherited: no
Percentages: refer to width of containing block
Media: visual
Computed value: for 'position:static', 'auto'. Otherwise: if specified as a length, the corresponding absolute length; if specified as a percentage, the specified value; otherwise, 'auto'.

Like 'top', but specifies how far a box's right margin edge is offset to the left of the right edge of the box's containing block [p. 128] . For relatively positioned boxes, the offset is with respect to the right edge of the box itself.

'bottom'

Value: <length> | <percentage> | auto | inherit
Initial: auto
Applies to: positioned elements
Inherited: no
Percentages: refer to height of containing block
Media: visual
Computed value: for 'position:static', 'auto'. Otherwise: if specified as a length, the corresponding absolute length; if specified as a percentage, the specified value; otherwise, 'auto'.

Like 'top', but specifies how far a box's bottom margin edge is offset above the bottom of the box's containing block [p. 128] . For relatively positioned boxes, the offset is with respect to the bottom edge of the box itself.

'left'

<i>Value:</i>	<length> <percentage> auto inherit
<i>Initial:</i>	auto
<i>Applies to:</i>	positioned elements
<i>Inherited:</i>	no
<i>Percentages:</i>	refer to width of containing block
<i>Media:</i>	visual
<i>Computed value:</i>	for 'position:static', 'auto'. Otherwise: if specified as a length, the corresponding absolute length; if specified as a percentage, the specified value; otherwise, 'auto'.

Like 'top', but specifies how far a box's left margin edge is offset to the right of the left edge of the box's containing block [p. 128] . For relatively positioned boxes, the offset is with respect to the left edge of the box itself.

The values for the four properties have the following meanings:

<length>

The offset is a fixed distance from the reference edge. Negative values are allowed.

<percentage>

The offset is a percentage of the containing block's width (for 'left' or 'right') or height (for 'top' and 'bottom'). Negative values are allowed.

auto

For non-replaced elements, the effect of this value depends on which of related properties have the value 'auto' as well. See the sections on the width [p. 177] and height [p. 186] of absolutely positioned [p. 152] , non-replaced elements for details. For replaced elements, the effect of this value depends only on the intrinsic dimensions of the replaced content. See the sections on the width [p. 179] and height [p. 187] of absolutely positioned, replaced elements for details.

9.4 Normal flow

Boxes in the normal flow belong to a formatting context, which may be block or inline, but not both simultaneously. Block-level [p. 129] boxes participate in a block formatting [p. 139] context. Inline-level boxes [p. 131] participate in an inline formatting [p. 139] context.

9.4.1 Block formatting contexts

Floats, absolutely positioned elements, block containers (such as inline-blocks, table-cells, and table-captions) that are not block boxes, and block boxes with 'overflow' other than 'visible' (except when that value has been propagated to the viewport) establish new block formatting contexts.

In a block formatting context, boxes are laid out one after the other, vertically, beginning at the top of a containing block. The vertical distance between two sibling boxes is determined by the 'margin' properties. Vertical margins between adjacent block-level boxes in a block formatting context collapse [p. 117] .

In a block formatting context, each box's left outer edge touches the left edge of the containing block (for right-to-left formatting, right edges touch). This is true even in the presence of floats (although a box's *line boxes* may shrink due to the floats), unless the box establishes a new block formatting context (in which case the box itself *may* become narrower [p. 143] due to the floats).

For information about page breaks in paged media, please consult the section on allowed page breaks [p. 227] .

9.4.2 Inline formatting contexts

In an inline formatting context, boxes are laid out horizontally, one after the other, beginning at the top of a containing block. Horizontal margins, borders, and padding are respected between these boxes. The boxes may be aligned vertically in different ways: their bottoms or tops may be aligned, or the baselines of text within them may be aligned. The rectangular area that contains the boxes that form a line is called a *line box*.

The width of a line box is determined by a containing block [p. 128] and the presence of floats. The height of a line box is determined by the rules given in the section on line height calculations [p. 190] .

A line box is always tall enough for all of the boxes it contains. However, it may be taller than the tallest box it contains (if, for example, boxes are aligned so that baselines line up). When the height of a box B is less than the height of the line box containing it, the vertical alignment of B within the line box is determined by the 'vertical-align' property. When several inline-level boxes cannot fit horizontally within a single line box, they are distributed among two or more vertically-stacked line boxes. Thus, a paragraph is a vertical stack of line boxes. Line boxes are stacked with no vertical separation and they never overlap.

In general, the left edge of a line box touches the left edge of its containing block and the right edge touches the right edge of its containing block. However, floating boxes may come between the containing block edge and the line box edge. Thus, although line boxes in the same inline formatting context generally have the same width (that of the containing block), they may vary in width if available horizontal space is reduced due to floats [p. 143] . Line boxes in the same inline formatting context generally vary in height (e.g., one line might contain a tall image while the

others contain only text).

When the total width of the inline-level boxes on a line is less than the width of the line box containing them, their horizontal distribution within the line box is determined by the 'text-align' property. If that property has the value 'justify', the user agent may stretch spaces and words in inline boxes (but not inline-table and inline-block boxes) as well.

When an inline box exceeds the width of a line box, it is split into several boxes and these boxes are distributed across several line boxes. If an inline box cannot be split (e.g., if the inline box contains a single character, or language specific word breaking rules disallow a break within the inline box, or if the inline box is affected by a white-space value of nowrap or pre), then the inline box overflows the line box.

When an inline box is split, margins, borders, and padding have no visual effect where the split occurs (or at any split, when there are several).

Inline boxes may also be split into several boxes *within the same line box* due to bidirectional text processing [p. 166] .

Line boxes that contain no text, no preserved white space, no inline elements with non-zero margins, padding, or borders, and no other in-flow content (such as images, inline blocks or inline tables), and do not end with a line feed must be treated as zero-height line boxes. For the purposes of margin collapsing, this line box must be ignored.

Here is an example of inline box construction. The following paragraph (created by the HTML block-level element P) contains anonymous text interspersed with the elements EM and STRONG:

```
<P>Several <EM>emphasized words</EM> appear
<STRONG>in this</STRONG> sentence, dear.</P>
```

The P element generates a block box that contains five inline boxes, three of which are anonymous:

- Anonymous: "Several"
- EM: "emphasized words"
- Anonymous: "appear"
- STRONG: "in this"
- Anonymous: "sentence, dear."

To format the paragraph, the user agent flows the five boxes into line boxes. In this example, the box generated for the P element establishes the containing block for the line boxes. If the containing block is sufficiently wide, all the inline boxes will fit into a single line box:

```
Several emphasized words appear in this sentence, dear.
```

If not, the inline boxes will be split up and distributed across several line boxes. The previous paragraph might be split as follows:

Several *emphasized words* appear
in this sentence, dear.

or like this:

Several *emphasized*
 words appear **in this**
 sentence, dear.

In the previous example, the EM box was split into two EM boxes (call them "split1" and "split2"). Margins, borders, padding, or text decorations have no visible effect after split1 or before split2.

Consider the following example:

```
<!DOCTYPE HTML PUBLIC "-//W3C//DTD HTML 4.01//EN">
<HTML>
  <HEAD>
    <TITLE>Example of inline flow on several lines</TITLE>
    <STYLE type="text/css">
      EM {
        padding: 2px;
        margin: 1em;
        border-width: medium;
        border-style: dashed;
        line-height: 2.4em;
      }
    </STYLE>
  </HEAD>
  <BODY>
    <P>Several <EM>emphasized words</EM> appear here.</P>
  </BODY>
</HTML>
```

Depending on the width of the P, the boxes may be distributed as follows:

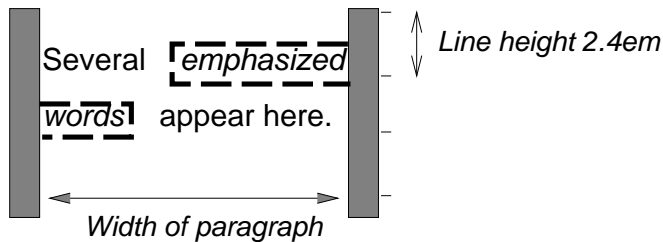

- The margin is inserted before "emphasized" and after "words".
- The padding is inserted before, above, and below "emphasized" and after, above, and below "words". A dashed border is rendered on three sides in each case.

9.4.3 Relative positioning

Once a box has been laid out according to the normal flow [p. 138] or floated, it may be shifted relative to this position. This is called *relative positioning*. Offsetting a box (B1) in this way has no effect on the box (B2) that follows: B2 is given a position as if B1 were not offset and B2 is not re-positioned after B1's offset is applied. This implies that relative positioning may cause boxes to overlap. However, if relative positioning causes an 'overflow:auto' or 'overflow:scroll' box to have overflow, the UA must allow the user to access this content (at its offset position), which, through the creation of scrollbars, may affect layout.

A relatively positioned box keeps its normal flow size, including line breaks and the space originally reserved for it. The section on containing blocks [p. 128] explains when a relatively positioned box establishes a new containing block.

For relatively positioned elements, 'left' and 'right' move the box(es) horizontally, without changing their size. 'left' moves the boxes to the right, and 'right' moves them to the left. Since boxes are not split or stretched as a result of 'left' or 'right', the used values are always: left = -right.

If both 'left' and 'right' are 'auto' (their initial values), the used values are '0' (i.e., the boxes stay in their original position).

If 'left' is 'auto', its used value is minus the value of 'right' (i.e., the boxes move to the left by the value of 'right').

If 'right' is specified as 'auto', its used value is minus the value of 'left'.

If neither 'left' nor 'right' is 'auto', the position is over-constrained, and one of them has to be ignored. If the 'direction' property of the containing block is 'ltr', the value of 'left' wins and 'right' becomes '-left'. If 'direction' of the containing block is 'rtl', 'right' wins and 'left' is ignored.

Example(s):

Example. The following three rules are equivalent:

```
div.a8 { position: relative; direction: ltr; left: -1em; right: auto }
div.a8 { position: relative; direction: ltr; left: auto; right: 1em }
div.a8 { position: relative; direction: ltr; left: -1em; right: 5em }
```

The 'top' and 'bottom' properties move relatively positioned element(s) up or down without changing their size. 'top' moves the boxes down, and 'bottom' moves them up. Since boxes are not split or stretched as a result of 'top' or 'bottom', the used values are always: top = -bottom. If both are 'auto', their used values are both '0'. If one of them is 'auto', it becomes the negative of the other. If neither is 'auto', 'bottom' is ignored (i.e., the used value of 'bottom' will be minus the value of 'top').

Note. Dynamic movement of relatively positioned boxes can produce animation effects in scripting environments (see also the 'visibility' property). Although relative positioning may be used as a form of superscripting and subscripting, the line height is not automatically adjusted to take the positioning into consideration. See the description of line height calculations [p. 190] for more information.

Examples of relative positioning are provided in the section comparing normal flow, floats, and absolute positioning [p. 155] .

9.5 Floats

A float is a box that is shifted to the left or right on the current line. The most interesting characteristic of a float (or "floated" or "floating" box) is that content may flow along its side (or be prohibited from doing so by the 'clear' property). Content flows down the right side of a left-floated box and down the left side of a right-floated box. The following is an introduction to float positioning and content flow; the exact rules [p. 148] governing float behavior are given in the description of the 'float' property.

A floated box is shifted to the left or right until its outer edge touches the containing block edge or the outer edge of another float. If there is a line box, the outer top of the floated box is aligned with the top of the current line box.

If there is not enough horizontal room for the float, it is shifted downward until either it fits or there are no more floats present.

Since a float is not in the flow, non-positioned block boxes created before and after the float box flow vertically as if the float did not exist. However, line boxes created next to the float are shortened to make room for the margin box of the float.

A line box is next to a float when there exists a vertical position that satisfies all of these four conditions: (a) at or below the top of the line box, (b) at or above the bottom of the line box, (c) below the top margin edge of the float, and (d) above the bottom margin edge of the float.

Note: this means that floats with zero height or negative height do not move line boxes.

If a shortened line box is too small to contain any further content, then it is shifted downward until either it fits or there are no more floats present. Any content in the current line before a floated box is reflowed in the first available line on the other side of the float. In other words, if inline-level boxes are placed on the line before a left float is encountered that fits in the remaining line box space, the left float is placed on that line, aligned with the top of the line box, and then the inline-level boxes already on the line are moved accordingly to the right of the float (the right being the other side of the left float) and vice versa for rtl and right floats.

The border box of a table, a block-level replaced element, or an element in the normal flow that establishes a new block formatting context [p. 139] (such as an element with 'overflow' other than 'visible') must not overlap any floats in the same block formatting context as the element itself. If necessary, implementations should clear the said element by placing it below any preceding floats, but may place it adjacent to such floats if there is sufficient space. They may even make the border box of said element narrower than defined by section 10.3.3. [p. 176] CSS2 does not define when a UA may put said element next to the float or by how much said element may become narrower.

Example(s):

Example. In the following document fragment, the containing block is too narrow to contain the content next to the float, so the content gets moved to below the floats where it is aligned in the line box according to the text-align property.

```
p { width: 10em; border: solid aqua; }
span { float: left; width: 5em; height: 5em; border: solid blue; }
```

...

```
<p>
  <span> </span>
  Supercalifragilisticexpialidocious
</p>
```

This fragment might look like this:

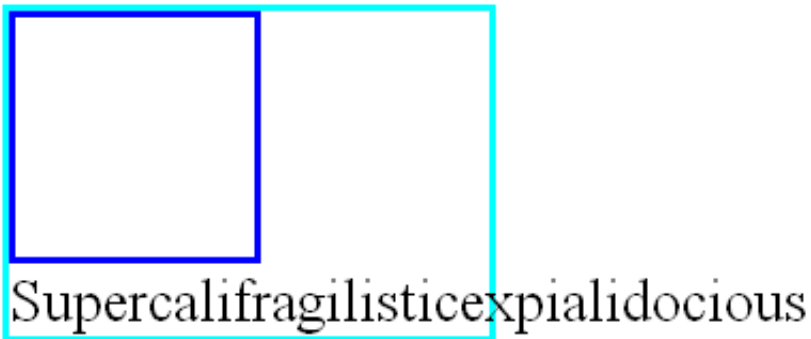

Several floats may be adjacent, and this model also applies to adjacent floats in the same line.

Example(s):

The following rule floats all IMG boxes with `class="icon"` to the left (and sets the left margin to '0'):

```
img.icon {
  float: left;
  margin-left: 0;
}
```

Consider the following HTML source and style sheet:

```
<!DOCTYPE HTML PUBLIC "-//W3C//DTD HTML 4.01//EN">
<HTML>
  <HEAD>
    <TITLE>Float example</TITLE>
    <STYLE type="text/css">
      IMG { float: left }
      BODY, P, IMG { margin: 2em }
    </STYLE>
  </HEAD>
  <BODY>
```



```

<P><IMG src=img.png alt="This image will illustrate floats">
  Some sample text that has no other...
</BODY>
</HTML>

```

The IMG box is floated to the left. The content that follows is formatted to the right of the float, starting on the same line as the float. The line boxes to the right of the float are shortened due to the float's presence, but resume their "normal" width (that of the containing block established by the P element) after the float. This document might be formatted as:

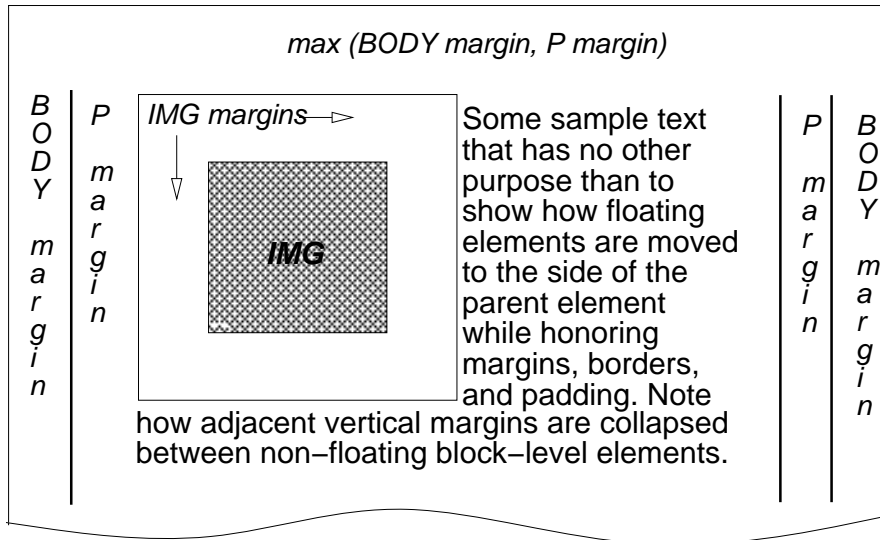

Formatting would have been exactly the same if the document had been:

```

<BODY>
  <P>Some sample text
  <IMG src=img.png alt="This image will illustrate floats">
    that has no other...
</BODY>

```

because the content to the left of the float is displaced by the float and reflowed down its right side.

As stated in section 8.3.1 [p. 117], the margins of floating boxes never collapse [p. 117] with margins of adjacent boxes. Thus, in the previous example, vertical margins do not collapse [p. 117] between the P box and the floated IMG box.

The contents of floats are stacked as if floats generated new stacking contexts, except that any positioned elements and elements that actually create new stacking contexts take part in the float's parent stacking context. A float can overlap other boxes in the normal flow (e.g., when a normal flow box next to a float has negative margins). When this happens, floats are rendered in front of non-positioned in-flow blocks, but behind in-flow inlines.

Example(s):

Here is another illustration, showing what happens when a float overlaps borders of elements in the normal flow.

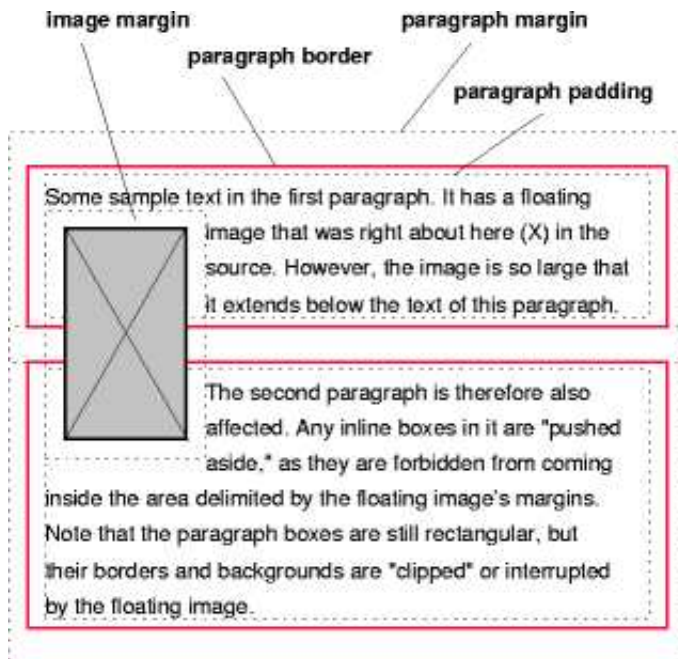

A floating image obscures borders of block boxes it overlaps.

The following example illustrates the use of the 'clear' property to prevent content from flowing next to a float.

Example(s):

Assuming a rule such as this:

```
p { clear: left }
```

formatting might look like this:

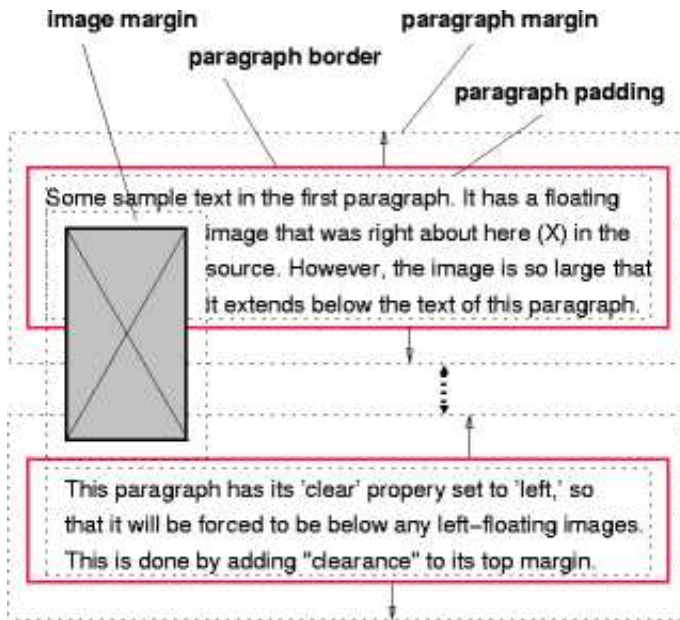

Both paragraphs have set 'clear: left', which causes the second paragraph to be "pushed down" to a position below the float — "clearance" is added above its top margin to accomplish this (see the 'clear' property).

9.5.1 Positioning the float: the 'float' property

'float'

<i>Value:</i>	left right none inherit
<i>Initial:</i>	none
<i>Applies to:</i>	all, but see 9.7 [p. 154]
<i>Inherited:</i>	no
<i>Percentages:</i>	N/A
<i>Media:</i>	visual
<i>Computed value:</i>	as specified

This property specifies whether a box should float to the left, right, or not at all. It may be set for any element, but only applies to elements that generate boxes that are not absolutely positioned [p. 152]. The values of this property have the following meanings:

left

The element generates a block [p. ??] box that is floated to the left. Content flows on the right side of the box, starting at the top (subject to the 'clear' property).

right

Similar to 'left', except the box is floated to the right, and content flows on the left side of the box, starting at the top.

none

The box is not floated.

User agents may treat float as 'none' on the root element.

Here are the precise rules that govern the behavior of floats:

1. The left outer edge [p. 112] of a left-floating box may not be to the left of the left edge of its containing block [p. 128] . An analogous rule holds for right-floating elements.
2. If the current box is left-floating, and there are any left-floating boxes generated by elements earlier in the source document, then for each such earlier box, either the left outer edge [p. 112] of the current box must be to the right of the right outer edge [p. 112] of the earlier box, or its top must be lower than the bottom of the earlier box. Analogous rules hold for right-floating boxes.
3. The right outer edge [p. 112] of a left-floating box may not be to the right of the left outer edge [p. 112] of any right-floating box that is to the right of it. Analogous rules hold for right-floating elements.
4. A floating box's outer top [p. 112] may not be higher than the top of its containing block [p. 128] . When the float occurs between two collapsing margins, the float is positioned as if it had an otherwise empty anonymous block parent [p. 129] taking part in the flow. The position of such a parent is defined by the rules [p. 117] in the section on margin collapsing.
5. The outer top [p. 112] of a floating box may not be higher than the outer top of any block [p. ??] or floated [p. 143] box generated by an element earlier in the source document.
6. The outer top [p. 112] of an element's floating box may not be higher than the top of any line-box [p. 139] containing a box generated by an element earlier in the source document.
7. A left-floating box that has another left-floating box to its left may not have its right outer edge to the right of its containing block's right edge. (Loosely: a left float may not stick out at the right edge, unless it is already as far to the left as possible.) An analogous rule holds for right-floating elements.
8. A floating box must be placed as high as possible.
9. A left-floating box must be put as far to the left as possible, a right-floating box as far to the right as possible. A higher position is preferred over one that is further to the left/right.

References to other elements in these rules refer only to other elements in the same block formatting context [p. 139] as the float.

Example(s):

This HTML fragment results in the **b** floating to the right.

```
<P>a<SPAN style="float: right">b</SPAN></P>
```

If the P element's width is enough, the a and the b will be side by side. It might look like this:



9.5.2 Controlling flow next to floats: the 'clear' property

'clear'

<i>Value:</i>	none left right both inherit
<i>Initial:</i>	none
<i>Applies to:</i>	block-level elements
<i>Inherited:</i>	no
<i>Percentages:</i>	N/A
<i>Media:</i>	visual
<i>Computed value:</i>	as specified

This property indicates which sides of an element's box(es) may *not* be adjacent to an earlier floating box. The 'clear' property does not consider floats inside the element itself or in other block formatting contexts. [p. 139]

For run-in boxes [p. 132], this property applies to the final block box to which the run-in box belongs.

Values have the following meanings when applied to non-floating block-level boxes:

left

Requires that the top border edge of the box be below the bottom outer edge of any left-floating boxes that resulted from elements earlier in the source document.

right

Requires that the top border edge of the box be below the bottom outer edge of any right-floating boxes that resulted from elements earlier in the source document.

both

Requires that the top border edge of the box be below the bottom outer edge of any right-floating and left-floating boxes that resulted from elements earlier in the source document.

none

No constraint on the box's position with respect to floats.

Values other than 'none' potentially introduce *clearance*. Clearance inhibits margin collapsing and acts as spacing above the margin-top of an element. It is used to push the element vertically past the float.

Computing the clearance of an element on which 'clear' is set is done by first determining the hypothetical position of the element's top border edge within its parent block. This position is where the actual top border edge would have been if the element had a non-zero bottom border and its 'clear' property had been 'none'.

If this hypothetical position of the element's top border edge is not past the relevant floats, then clearance is introduced, and margins collapse according to the rules in 8.3.1.

Then the amount of clearance is set to the greater of:

1. The amount necessary to place the border edge of the block even with the bottom outer edge of the lowest float that is to be cleared.
2. The amount necessary to place the top border edge of the block at its hypothetical position.

Note: The clearance can be negative or zero.

Example(s):

Example 1. Assume (for the sake of simplicity), that we have just three boxes, in this order: block B1 with a bottom margin of M1 (B1 has no children and no padding or border), floating block F with a height H, and block B2 with a top margin of M2 (no padding or border, no children). B2 has 'clear' set to 'both'. We also assume B2 is not empty.

Without considering the 'clear' property on B2, we have the situation in the diagram below. The margins of B1 and B2 collapse. Let's say the bottom border edge of B1 is at $y = 0$, then the top of F is at $y = M1$, the top border edge of B2 is at $y = \max(M1, M2)$, and the bottom of F is at $y = M1 + H$.

Float F extends into the margin above M2.

We also assume that B2 is not below F, i.e., we are in the situation described in the spec where we need to add clearance. That means:

$$\max(M1, M2) < M1 + H$$

We need to compute clearance C twice, C1 and C2, and keep the greater of the two: $C = \max(C1, C2)$. The first way is to put the top of B2 flush with the bottom of F, i.e., at $y = M1 + H$. That means, because the margins no longer collapse with a clearance between them:

$$\text{bottom of F} = \text{top border edge of B2} \quad \square$$

$$M1 + H = M1 + C1 + M2 \quad \square$$

$$C1 = M1 + H - M1 - M2$$

$$= H - M2$$

The second computation is to keep the top of B2 where it is, i.e., at $y = \max(M1, M2)$. That means:

$$\max(M1, M2) = M1 + C2 + M2 \quad \square$$

$$C2 = \max(M1, M2) - M1 - M2$$

We assumed that $\max(M1, M2) < M1 + H$, which implies

$$C2 = \max(M1, M2) - M1 - M2 < M1 + H - M1 - M2 = H - M2 \quad \square$$

$$C2 < H - M2$$

And, as $C1 = H - M2$, it follows that

$$C2 < C1$$

and hence

$$C = \max(C1, C2) = C1$$

Example(s):

Example 2. An example of negative clearance is this situation, in which the clearance is -1em. (Assume none of the elements have borders or padding):

```
<p style="margin-bottom: 4em">
  First paragraph.

<p style="float: left; height: 2em; margin: 0">
  Floating paragraph.

<p style="clear: left; margin-top: 3em">
  Last paragraph.
```

Explanation: Without the 'clear', the first and last paragraphs' margins would collapse and the last paragraph's top border edge would be flush with the top of the floating paragraph. But the 'clear' requires the top border edge to be *below* the float, i.e., 2em lower. This means that clearance must be introduced. Accordingly, the margins no longer collapse and the amount of clearance is set so that clearance + margin-top = 2em, i.e., clearance = 2em - margin-top = 2em - 3em = -1em.

When the property is set on floating elements, it results in a modification of the rules [p. 148] for positioning the float. An extra constraint (#10) is added:

- The top outer edge [p. 112] of the float must be below the bottom outer edge of all earlier left-floating boxes (in the case of 'clear: left'), or all earlier right-floating boxes (in the case of 'clear: right'), or both ('clear: both').

Note. This property applied to all elements in CSS1 [p. ??] . Implementations may therefore have supported this property on all elements. In CSS2 and CSS 2.1 the 'clear' property only applies to block-level elements. Therefore authors should only use this property on block-level elements. If an implementation does support clear on inline elements, rather than setting a clearance as explained above, the implementation should force a break and effectively insert one or more empty line boxes (or shifting the new line box downward as described in section 9.5 [p. 143]) to move the top of the cleared inline's line box to below the respective floating box(es).

9.6 Absolute positioning

In the absolute positioning model, a box is explicitly offset with respect to its containing block. It is removed from the normal flow entirely (it has no impact on later siblings). An absolutely positioned box establishes a new containing block for normal flow children and absolutely (but not fixed) positioned descendants. However, the contents of an absolutely positioned element do not flow around any other boxes. They may obscure the contents of another box (or be obscured themselves), depending on the stack levels [p. 165] of the overlapping boxes.

References in this specification to an *absolutely positioned element* (or its box) imply that the element's 'position' property has the value 'absolute' or 'fixed'.

9.6.1 Fixed positioning

Fixed positioning is a subcategory of absolute positioning. The only difference is that for a fixed positioned box, the containing block is established by the viewport [p. 128] . For continuous media [p. 110] , fixed boxes do not move when the document is scrolled. In this respect, they are similar to fixed background images [p. 232] . For paged media [p. 221] , boxes with fixed positions are repeated on every page. This is useful for placing, for instance, a signature at the bottom of each page. Boxes with fixed position that are larger than the page area are clipped. Parts of the fixed position box that are not visible in the initial containing block will not print.

In paged media, where there is no viewport, a 'fixed' background is fixed with respect to the page box and is therefore replicated on every page.

Authors may use fixed positioning to create frame-like presentations. Consider the following frame layout:

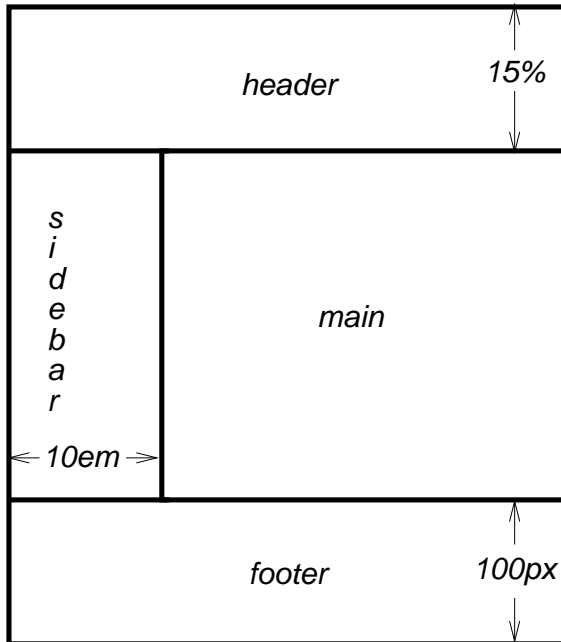

This might be achieved with the following HTML document and style rules:

```
<!DOCTYPE HTML PUBLIC "-//W3C//DTD HTML 4.01//EN">
<HTML>
  <HEAD>
    <TITLE>A frame document with CSS 2.1</TITLE>
    <STYLE type="text/css" media="screen">
      BODY { height: 8.5in } /* Required for percentage heights below */
      #header {
        position: fixed;
        width: 100%;
        height: 15%;
        top: 0;
        right: 0;
        bottom: auto;
        left: 0;
      }
      #sidebar {
        position: fixed;
        width: 10em;
        height: auto;
        top: 15%;
        right: auto;
        bottom: 100px;
        left: 0;
      }
      #main {
        position: fixed;
        width: auto;
        height: auto;
        top: 15%;
        right: 0;
        bottom: 100px;
        left: 10em;
      }
    </STYLE>
  </HEAD>
  <BODY>
    <div id="header">
      <h1>Header</h1>
    </div>
    <div id="sidebar">
      <h2>Sidebar</h2>
    </div>
    <div id="main">
      <h1>Main</h1>
    </div>
    <div id="footer">
      <h2>Footer</h2>
    </div>
  </BODY>
</HTML>
```

```

    }
    #footer {
      position: fixed;
      width: 100%;
      height: 100px;
      top: auto;
      right: 0;
      bottom: 0;
      left: 0;
    }
  </STYLE>
</HEAD>
<BODY>
  <DIV id="header"> ... </DIV>
  <DIV id="sidebar"> ... </DIV>
  <DIV id="main"> ... </DIV>
  <DIV id="footer"> ... </DIV>
</BODY>
</HTML>

```

9.7 Relationships between 'display', 'position', and 'float'

The three properties that affect box generation and layout — 'display', 'position', and 'float' — interact as follows:

1. If 'display' has the value 'none', then 'position' and 'float' do not apply. In this case, the element generates no box.
2. Otherwise, if 'position' has the value 'absolute' or 'fixed', the box is absolutely positioned, the computed value of 'float' is 'none', and display is set according to the table below. The position of the box will be determined by the 'top', 'right', 'bottom' and 'left' properties and the box's containing block.
3. Otherwise, if 'float' has a value other than 'none', the box is floated and 'display' is set according to the table below.
4. Otherwise, if the element is the root element, 'display' is set according to the table below.
5. Otherwise, the remaining 'display' property values apply as specified.

Specified value	Computed value
inline-table	table
inline, run-in, table-row-group, table-column, table-column-group, table-header-group, table-footer-group, table-row, table-cell, table-caption, inline-block	block
others	same as specified

9.8 Comparison of normal flow, floats, and absolute positioning

To illustrate the differences between normal flow, relative positioning, floats, and absolute positioning, we provide a series of examples based on the following HTML:

```
<!DOCTYPE HTML PUBLIC "-//W3C//DTD HTML 4.01//EN">
<HTML>
  <HEAD>
    <TITLE>Comparison of positioning schemes</TITLE>
  </HEAD>
  <BODY>
    <P>Beginning of body contents.
      <SPAN id="outer"> Start of outer contents.
        <SPAN id="inner"> Inner contents.</SPAN>
      End of outer contents.</SPAN>
    End of body contents.
  </P>
</BODY>
</HTML>
```

In this document, we assume the following rules:

```
body { display: block; font-size: 12px; line-height: 200%;
       width: 400px; height: 400px }
p    { display: block }
span { display: inline }
```

The final positions of boxes generated by the *outer* and *inner* elements vary in each example. In each illustration, the numbers to the left of the illustration indicate the normal flow [p. 138] position of the double-spaced (for clarity) lines.

Note. The diagrams in this section are illustrative and not to scale. They are meant to highlight the differences between the various positioning schemes in CSS 2.1, and are not intended to be reference renderings of the examples given.

9.8.1 Normal flow

Consider the following CSS declarations for *outer* and *inner* that do not alter the normal flow [p. 138] of boxes:

```
#outer { color: red }
#inner { color: blue }
```

The P element contains all inline content: anonymous inline text [p. 132] and two SPAN elements. Therefore, all of the content will be laid out in an inline formatting context, within a containing block established by the P element, producing something like:

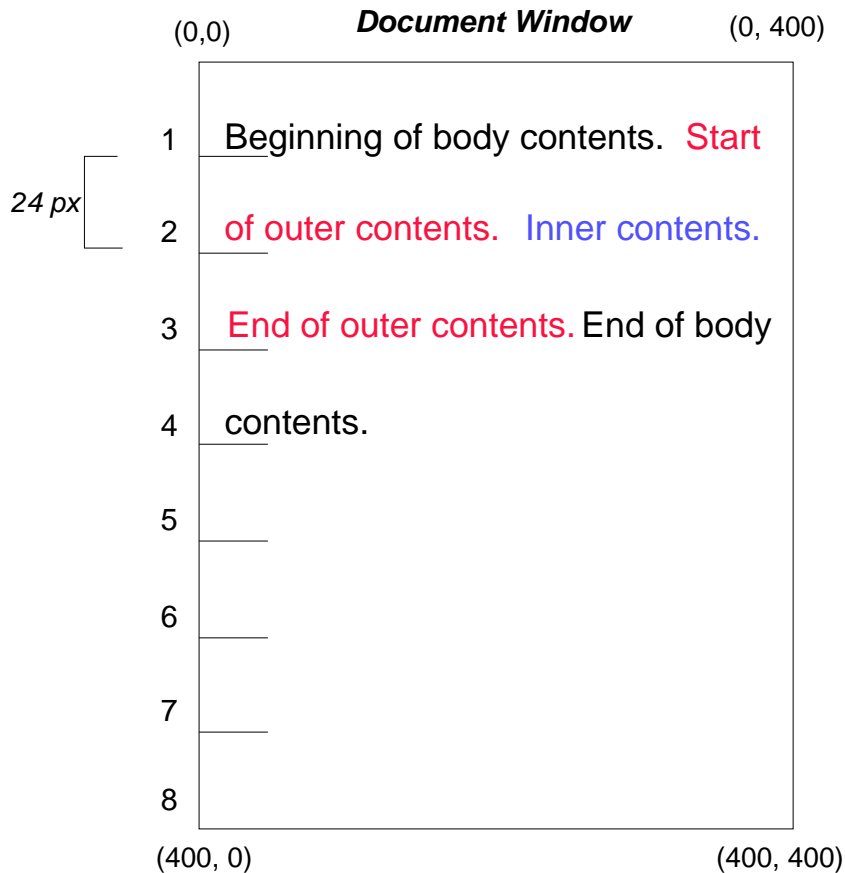

9.8.2 Relative positioning

To see the effect of relative positioning [p. 142], we specify:

```
#outer { position: relative; top: -12px; color: red }
#inner { position: relative; top: 12px; color: blue }
```

Text flows normally up to the *outer* element. The *outer* text is then flowed into its normal flow position and dimensions at the end of line 1. Then, the inline boxes containing the text (distributed over three lines) are shifted as a unit by '-12px' (upwards).

The contents of *inner*, as a child of *outer*, would normally flow immediately after the words "of outer contents" (on line 1.5). However, the *inner* contents are themselves offset relative to the *outer* contents by '12px' (downwards), back to their original position on line 2.

Note that the content following *outer* is not affected by the relative positioning of *outer*.

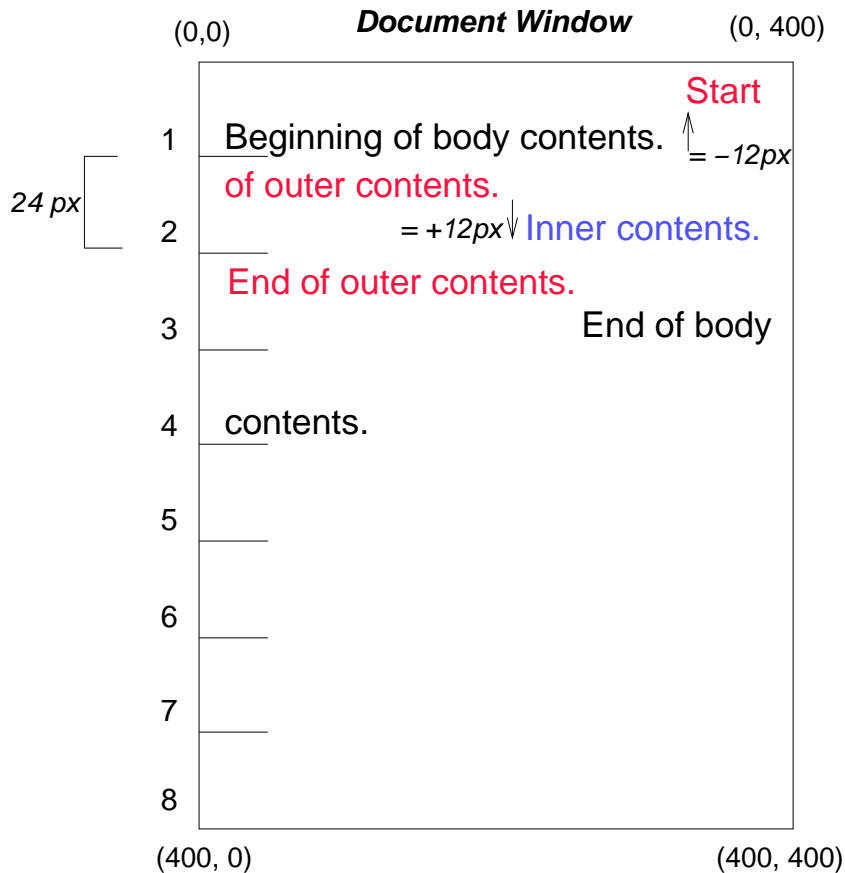

Note also that had the offset of *outer* been '-24px', the text of *outer* and the body text would have overlapped.

9.8.3 Floating a box

Now consider the effect of floating [p. 143] the *inner* element's text to the right by means of the following rules:

```
#outer { color: red }
#inner { float: right; width: 130px; color: blue }
```

Text flows normally up to the *inner* box, which is pulled out of the flow and floated to the right margin (its 'width' has been assigned explicitly). Line boxes to the left of the float are shortened, and the document's remaining text flows into them.

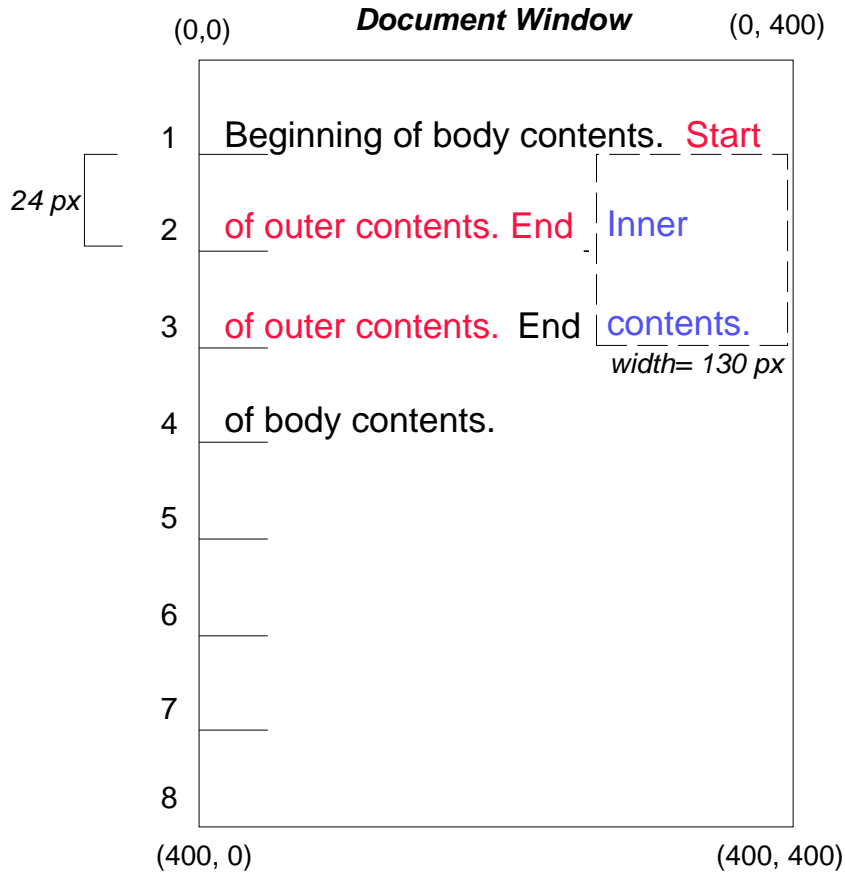

To show the effect of the 'clear' property, we add a *sibling* element to the example:

```
<!DOCTYPE HTML PUBLIC "-//W3C//DTD HTML 4.01//EN">
<HTML>
  <HEAD>
    <TITLE>Comparison of positioning schemes II</TITLE>
  </HEAD>
  <BODY>
    <P>Beginning of body contents.
      <SPAN id=outer> Start of outer contents.
        <SPAN id=inner> Inner contents.</SPAN>
        <SPAN id=sibling> Sibling contents.</SPAN>
      End of outer contents.</SPAN>
    End of body contents.
  </P>
</BODY>
</HTML>
```

The following rules:

```
#inner { float: right; width: 130px; color: blue }
#sibling { color: red }
```

cause the *inner* box to float to the right as before and the document's remaining text to flow into the vacated space:

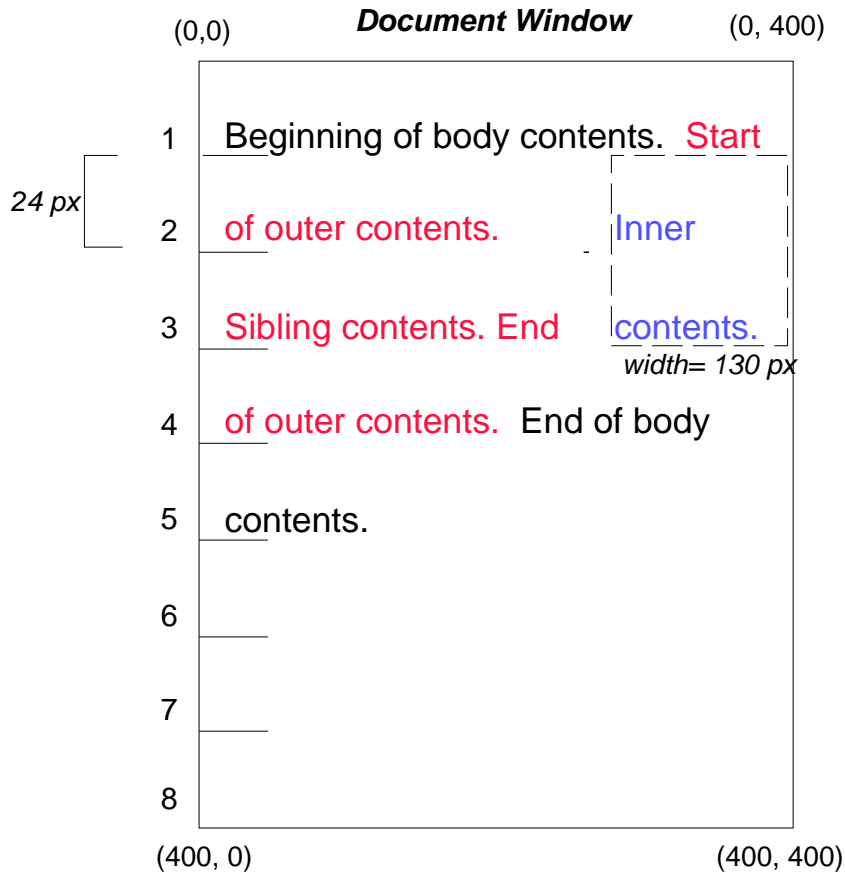

However, if the 'clear' property on the *sibling* element is set to 'right' (i.e., the generated *sibling* box will not accept a position next to floating boxes to its right), the *sibling* content begins to flow below the float:

```
#inner { float: right; width: 130px; color: blue }
#sibling { clear: right; color: red }
```

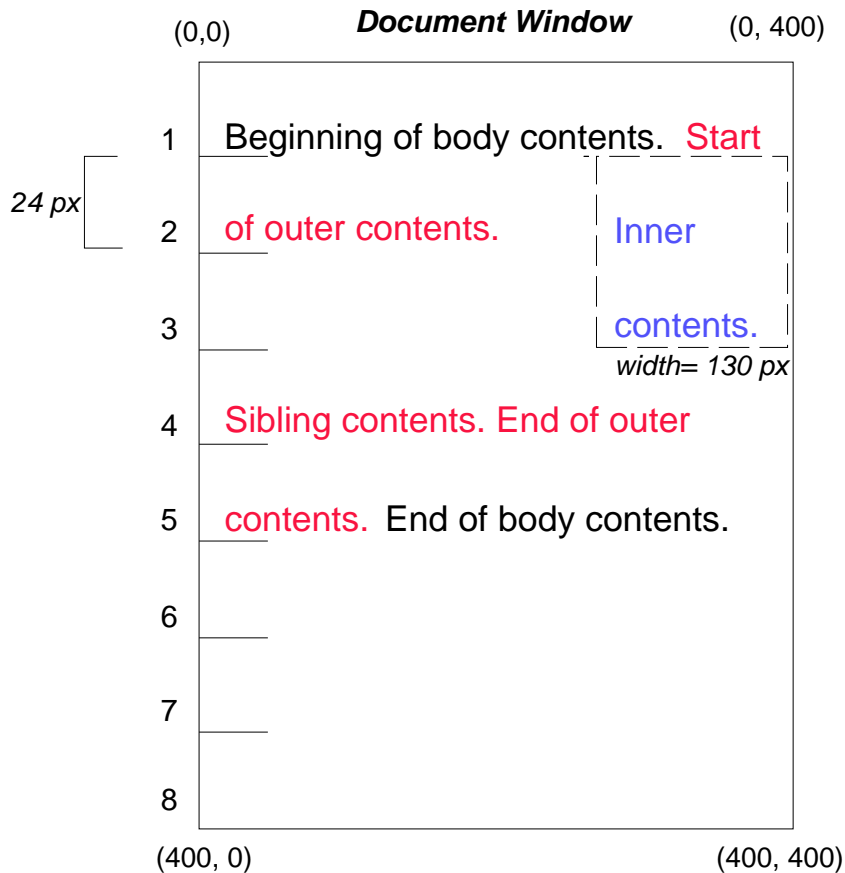

9.8.4 Absolute positioning

Finally, we consider the effect of absolute positioning [p. 152]. Consider the following CSS declarations for *outer* and *inner*:

```
#outer {
  position: absolute;
  top: 200px; left: 200px;
  width: 200px;
  color: red;
}
#inner { color: blue }
```

which cause the top of the *outer* box to be positioned with respect to its containing block. The containing block for a positioned box is established by the nearest positioned ancestor (or, if none exists, the initial containing block [p. 171], as in our example). The top side of the *outer* box is '200px' below the top of the containing block and the left side is '200px' from the left side. The child box of *outer* is flowed normally with respect to its parent.

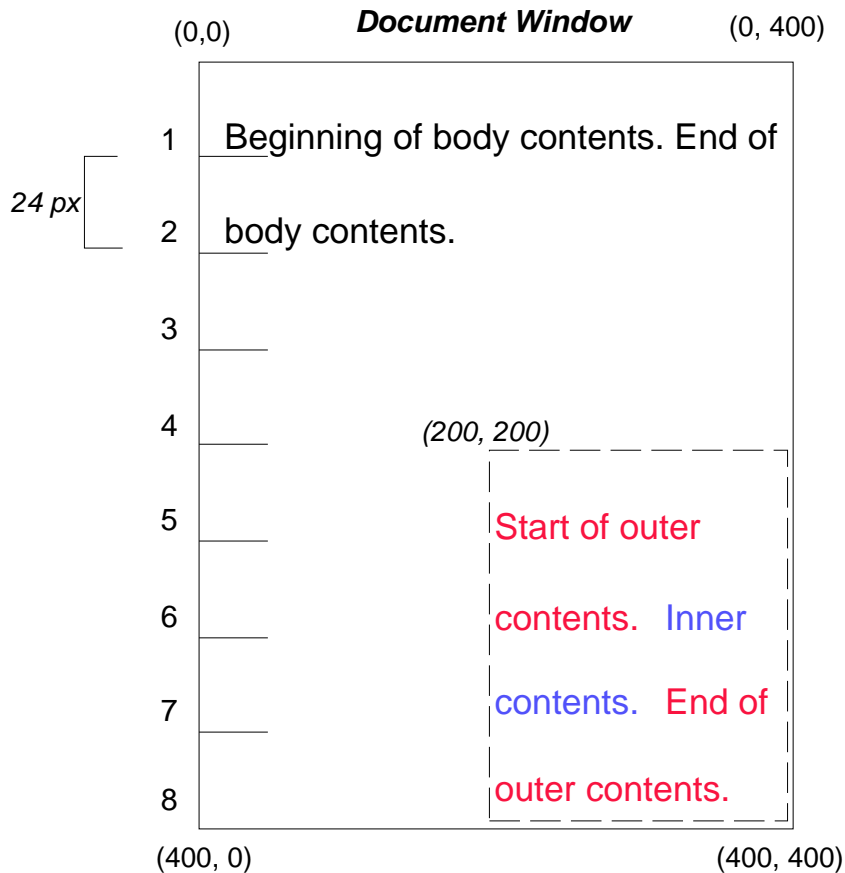

The following example shows an absolutely positioned box that is a child of a relatively positioned box. Although the parent *outer* box is not actually offset, setting its 'position' property to 'relative' means that its box may serve as the containing block for positioned descendants. Since the *outer* box is an inline box that is split across several lines, the first inline box's top and left edges (depicted by thick dashed lines in the illustration below) serve as references for 'top' and 'left' offsets.

```
#outer {
  position: relative;
  color: red
}
#inner {
  position: absolute;
  top: 200px; left: -100px;
  height: 130px; width: 130px;
  color: blue;
}
```

This results in something like the following:

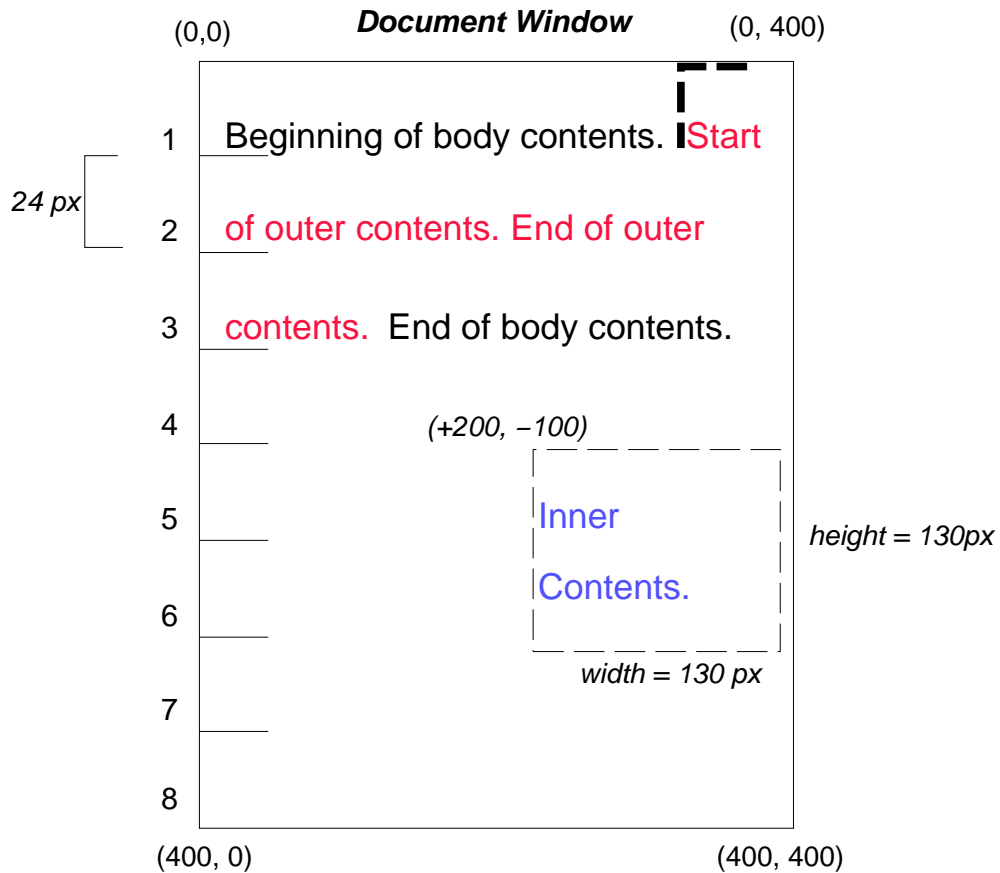

If we do not position the *outer* box:

```
#outer { color: red }
#inner {
  position: absolute;
  top: 200px; left: -100px;
  height: 130px; width: 130px;
  color: blue;
}
```

the containing block for *inner* becomes the initial containing block [p. 171] (in our example). The following illustration shows where the *inner* box would end up in this case.

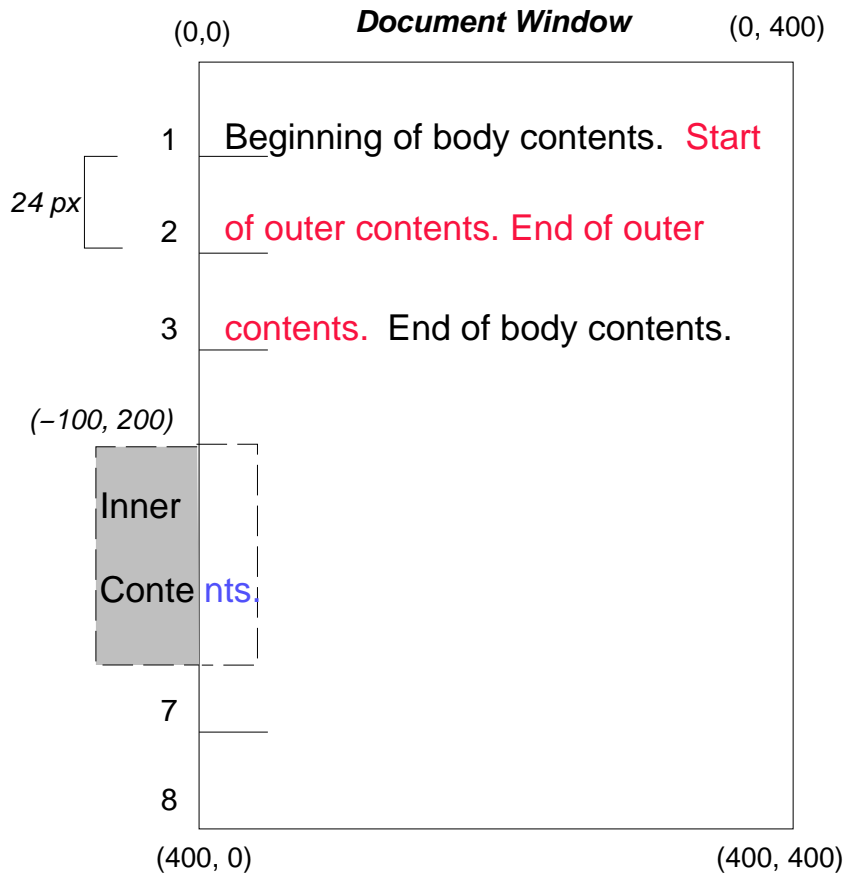

Relative and absolute positioning may be used to implement change bars, as shown in the following example. The following fragment:

```
<P style="position: relative; margin-right: 10px; left: 10px;">
I used two red hyphens to serve as a change bar. They
will "float" to the left of the line containing THIS
<SPAN style="position: absolute; top: auto; left: -1em; color: red;">--</SPAN>
word.</P>
```

might result in something like:

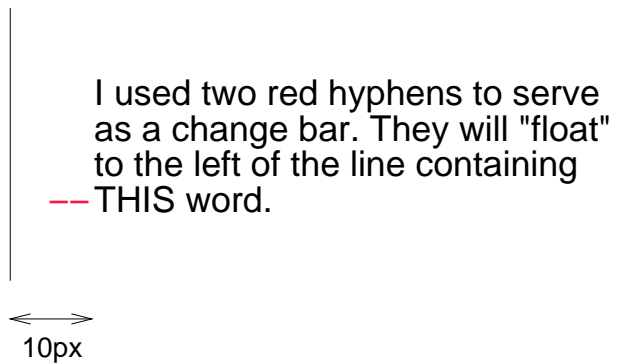

First, the paragraph (whose containing block sides are shown in the illustration) is flowed normally. Then it is offset '10px' from the left edge of the containing block (thus, a right margin of '10px' has been reserved in anticipation of the offset). The two hyphens acting as change bars are taken out of the flow and positioned at the current line (due to 'top: auto'), '-1em' from the left edge of its containing block (established by the P in its final position). The result is that the change bars seem to "float" to the left of the current line.

9.9 Layered presentation

9.9.1 Specifying the stack level: the 'z-index' property

'z-index'

<i>Value:</i>	auto <integer> inherit
<i>Initial:</i>	auto
<i>Applies to:</i>	positioned elements
<i>Inherited:</i>	no
<i>Percentages:</i>	N/A
<i>Media:</i>	visual
<i>Computed value:</i>	as specified

For a positioned box, the 'z-index' property specifies:

1. The stack level of the box in the current stacking context.
2. Whether the box establishes a stacking context.

Values have the following meanings:

<integer>

This integer is the stack level of the generated box in the current stacking context. The box also establishes a new stacking context.

auto

The stack level of the generated box in the current stacking context is '0'. The box does not establish a new stacking context unless it is the root element.

In this section, the expression "in front of" means closer to the user as the user faces the screen.

In CSS 2.1, each box has a position in three dimensions. In addition to their horizontal and vertical positions, boxes lie along a "z-axis" and are formatted one on top of the other. Z-axis positions are particularly relevant when boxes overlap visually. This section discusses how boxes may be positioned along the z-axis.

The order in which the rendering tree is painted onto the canvas is described in terms of stacking contexts. Stacking contexts can contain further stacking contexts. A stacking context is atomic from the point of view of its parent stacking context;

boxes in other stacking contexts may not come between any of its boxes.

Each box belongs to one *stacking context*. Each positioned box in a given stacking context has an integer *stack level*, which is its position on the z-axis relative other stack levels within the same stacking context. Boxes with greater stack levels are always formatted in front of boxes with lower stack levels. Boxes may have negative stack levels. Boxes with the same stack level in a stacking context are stacked back-to-front according to document tree order.

The root element forms the root stacking context. Other stacking contexts are generated by any positioned element (including relatively positioned elements) having a computed value of 'z-index' other than 'auto'. Stacking contexts are not necessarily related to containing blocks. In future levels of CSS, other properties may introduce stacking contexts, for example 'opacity [p. ??]' [CSS3COLOR].

Within each stacking context, the following layers are painted in back-to-front order.

1. the background and borders of the element forming the stacking context.
2. the child stacking contexts with negative stack levels (most negative first).
3. the in-flow, non-inline-level, non-positioned descendants.
4. the floating descendants.
5. the in-flow, inline-level, non-positioned descendants, including inline tables and inline blocks.
6. the child stacking contexts with stack level 0, and the positioned descendants with 'z-index: auto'.
7. the child stacking contexts with positive stack levels (least positive first).

Positioned elements with 'z-index: auto' (in layer 6), floats (layer 4), inline blocks (layer 5), and inline tables (layer 5), are painted as if those elements generated new stacking contexts, except that their positioned descendants and any child stacking contexts take part in the current stacking context.

This painting order is applied recursively to each stacking context. This description of stacking context painting order constitutes an overview of the detailed normative definition in Appendix E. [p. 437]

In the following example, the stack levels of the boxes (named with their "id" attributes) are: "text2"=0, "image"=1, "text3"=2, and "text1"=3. The "text2" stack level is inherited from the root box. The others are specified with the 'z-index' property.

```
<!DOCTYPE HTML PUBLIC "-//W3C//DTD HTML 4.01//EN">
<HTML>
  <HEAD>
    <TITLE>Z-order positioning</TITLE>
    <STYLE type="text/css">
      .pile {
        position: absolute;
        left: 2in;
        top: 2in;
        width: 3in;
        height: 3in;
      }
    </STYLE>
  </HEAD>
  <DIV id="text1" style="position: absolute; z-index: 3;">
    text1
  </DIV>
  <DIV id="text2" style="position: absolute; z-index: 0;">
    text2
  </DIV>
  <DIV id="text3" style="position: absolute; z-index: 2;">
    text3
  </DIV>
  <DIV id="image" style="position: absolute; z-index: 1;">
    image
  </DIV>
</HTML>
```

```

    }
  </STYLE>
</HEAD>
<BODY>
  <P>
    <IMG id="image" class="pile"
         src="butterfly.png" alt="A butterfly image"
         style="z-index: 1">

    <DIV id="text1" class="pile"
         style="z-index: 3">
      This text will overlay the butterfly image.
    </DIV>

    <DIV id="text2">
      This text will be beneath everything.
    </DIV>

    <DIV id="text3" class="pile"
         style="z-index: 2">
      This text will underlay text1, but overlay the butterfly image
    </DIV>
  </BODY>
</HTML>

```

This example demonstrates the notion of *transparency*. The default behavior of the background is to allow boxes behind it to be visible. In the example, each box transparently overlays the boxes below it. This behavior can be overridden by using one of the existing background properties [p. 232] .

9.10 Text direction: the 'direction' and 'unicode-bidi' properties

Conforming [p. 47] user agents that do not support bidirectional text may ignore the 'direction' and 'unicode-bidi' properties described in this section. This exception includes UAs that render right-to-left characters simply because a font on the system contains them but do not support the concept of right-to-left text direction.

The characters in certain scripts are written from right to left. In some documents, in particular those written with the Arabic or Hebrew script, and in some mixed-language contexts, text in a single (visually displayed) block may appear with mixed directionality. This phenomenon is called *bidirectionality*, or "bidi" for short.

The Unicode standard ([UNICODE], [UAX9]) defines a complex algorithm for determining the proper directionality of text. The algorithm consists of an implicit part based on character properties, as well as explicit controls for embeddings and overrides. CSS 2.1 relies on this algorithm to achieve proper bidirectional rendering. The 'direction' and 'unicode-bidi' properties allow authors to specify how the elements and attributes of a document language map to this algorithm.

User agents that support bidirectional text must apply the Unicode bidirectional algorithm to every sequence of inline-level boxes uninterrupted by a forced (bidi class B [p. ??]) break or block boundary. This sequence forms the "paragraph" unit in the bidirectional algorithm. The paragraph embedding level is set according to the value of the 'direction' property of the containing block rather than by the heuristic given in steps P2 and P3 of the Unicode algorithm.

Because the directionality of a text depends on the structure and semantics of the document language, these properties should in most cases be used only by designers of document type descriptions (DTDs), or authors of special documents. If a default style sheet specifies these properties, authors and users should not specify rules to override them.

The HTML 4 specification ([HTML4], section 8.2) defines bidirectionality behavior for HTML elements. The style sheet rules that would achieve the bidi behavior specified in [HTML4] are given in the sample style sheet [p. 436] . The HTML 4 specification also contains more information on bidirectionality issues.

'direction'

<i>Value:</i>	ltr rtl inherit
<i>Initial:</i>	ltr
<i>Applies to:</i>	all elements, but see prose
<i>Inherited:</i>	yes
<i>Percentages:</i>	N/A
<i>Media:</i>	visual
<i>Computed value:</i>	as specified

This property specifies the base writing direction of blocks and the direction of embeddings and overrides (see 'unicode-bidi') for the Unicode bidirectional algorithm. In addition, it specifies the direction of table [p. 269] column layout, the direction of horizontal overflow [p. 195] , and the position of an incomplete last line in a block in case of 'text-align: justify'.

Values for this property have the following meanings:

ltr

Left-to-right direction.

rtl

Right-to-left direction.

For the 'direction' property to affect reordering in inline elements, the 'unicode-bidi' property's value must be 'embed' or 'override'.

Note. *The 'direction' property, when specified for table column elements, is not inherited by cells in the column since columns are not the ancestors of the cells in the document tree. Thus, CSS cannot easily capture the "dir" attribute inheritance rules described in [HTML4], section 11.3.2.1.*

'unicode-bidi'

<i>Value:</i>	normal embed bidi-override inherit
<i>Initial:</i>	normal
<i>Applies to:</i>	all elements, but see prose
<i>Inherited:</i>	no
<i>Percentages:</i>	N/A
<i>Media:</i>	visual
<i>Computed value:</i>	as specified

Values for this property have the following meanings:

normal

The element does not open an additional level of embedding with respect to the bidirectional algorithm. For inline-level elements, implicit reordering works across element boundaries.

embed

If the element is inline, this value opens an additional level of embedding with respect to the bidirectional algorithm. The direction of this embedding level is given by the 'direction' property. Inside the element, reordering is done implicitly. This corresponds to adding a LRE (U+202A; for 'direction: ltr') or RLE (U+202B; for 'direction: rtl') at the start of the element and a PDF (U+202C) at the end of the element.

bidi-override

For inline-level elements this creates an override. For block container elements this creates an override for inline-level descendants not within another block-level, table-cell, table-caption, or inline-block element. This means that inside the element, reordering is strictly in sequence according to the 'direction' property; the implicit part of the bidirectional algorithm is ignored. This corresponds to adding a LRO (U+202D; for 'direction: ltr') or RLO (U+202E; for 'direction: rtl') at the start of the element or at the start of each anonymous child block box, if any, and a PDF (U+202C) at the end of the element.

The final order of characters in each block container is the same as if the bidi control codes had been added as described above, markup had been stripped, and the resulting character sequence had been passed to an implementation of the Unicode bidirectional algorithm for plain text that produced the same line-breaks as the styled text. In this process, replaced elements with 'display: inline' (and replaced elements with 'display: run-in', when they generate inline-level boxes) are treated as neutral characters, unless their 'unicode-bidi' property has a value other than 'normal', in which case they are treated as strong characters in the 'direction' specified for the element.

Please note that in order to be able to flow inline boxes in a uniform direction (either entirely left-to-right or entirely right-to-left), more inline boxes (including anonymous inline boxes) may have to be created, and some inline boxes may have to be split up and reordered before flowing.

Because the Unicode algorithm has a limit of *61 levels* of embedding, care should be taken not to use 'unicode-bidi' with a value other than 'normal' unless appropriate. In particular, a value of 'inherit' should be used with extreme caution. However, for elements that are, in general, intended to be displayed as blocks, a setting of 'unicode-bidi: embed' is preferred to keep the element together in case display is changed to inline (see example below).

The following example shows an XML document with bidirectional text. It illustrates an important design principle: DTD designers should take bidi into account both in the language proper (elements and attributes) and in any accompanying style sheets. The style sheets should be designed so that bidi rules are separate from other style rules. The bidi rules should not be overridden by other style sheets so that the document language's or DTD's bidi behavior is preserved.

Example(s):

In this example, lowercase letters stand for inherently left-to-right characters and uppercase letters represent inherently right-to-left characters:

```
<HEBREW>
  <PAR>HEBREW1 HEBREW2 english3 HEBREW4 HEBREW5</PAR>
  <PAR>HEBREW6 <EMPH>HEBREW7</EMPH> HEBREW8</PAR>
</HEBREW>
<ENGLISH>
  <PAR>english9 english10 english11 HEBREW12 HEBREW13</PAR>
  <PAR>english14 english15 english16</PAR>
  <PAR>english17 <HE-QUO>HEBREW18 english19 HEBREW20</HE-QUO></PAR>
</ENGLISH>
```

Since this is XML, the style sheet is responsible for setting the writing direction. This is the style sheet:

```
/* Rules for bidi */
HEBREW, HE-QUO {direction: rtl; unicode-bidi: embed}
ENGLISH        {direction: ltr; unicode-bidi: embed}

/* Rules for presentation */
HEBREW, ENGLISH, PAR {display: block}
EMPH                  {font-weight: bold}
```

The HEBREW element is a block with a right-to-left base direction, the ENGLISH element is a block with a left-to-right base direction. The PARs are blocks that inherit the base direction from their parents. Thus, the first two PARs are read starting at the top right, the final three are read starting at the top left. Please note that HEBREW and ENGLISH are chosen as element names for explicitness only; in general, element names should convey structure without reference to language.

The EMPH element is inline-level, and since its value for 'unicode-bidi' is 'normal' (the initial value), it has no effect on the ordering of the text. The HE-QUO element, on the other hand, creates an embedding.

The formatting of this text might look like this if the line length is long:

```
5WERBEH 4WERBEH english3 2WERBEH 1WERBEH
8WERBEH 7WERBEH 6WERBEH
english9 english10 english11 13WERBEH 12WERBEH
english14 english15 english16
english17 20WERBEH english19 18WERBEH
```

Note that the HE-QUO embedding causes HEBREW18 to be to the right of english19.

If lines have to be broken, it might be more like this:

```
2WERBEH 1WERBEH
-EH 4WERBEH english3
5WERB
-EH 7WERBEH 6WERBEH
8WERB
english9 english10 en-
english11 12WERBEH
13WERBEH
english14 english15
english16
english17 18WERBEH
20WERBEH english19
```

Because HEBREW18 must be read before english19, it is on the line above english19. Just breaking the long line from the earlier formatting would not have worked. Note also that the first syllable from english19 might have fit on the previous line, but hyphenation of left-to-right words in a right-to-left context, and vice versa, is usually suppressed to avoid having to display a hyphen in the middle of a line.

10 Visual formatting model details

Contents

10.1 Definition of "containing block"	171
10.2 Content width: the 'width' property	174
10.3 Calculating widths and margins	175
10.3.1 Inline, non-replaced elements	175
10.3.2 Inline, replaced elements	176
10.3.3 Block-level, non-replaced elements in normal flow	176
10.3.4 Block-level, replaced elements in normal flow	177
10.3.5 Floating, non-replaced elements	177
10.3.6 Floating, replaced elements	177
10.3.7 Absolutely positioned, non-replaced elements	177
10.3.8 Absolutely positioned, replaced elements	179
10.3.9 'Inline-block', non-replaced elements in normal flow	179
10.3.10 'Inline-block', replaced elements in normal flow	180
10.4 Minimum and maximum widths: 'min-width' and 'max-width'	180
10.5 Content height: the 'height' property	182
10.6 Calculating heights and margins	184
10.6.1 Inline, non-replaced elements	184
10.6.2 Inline replaced elements, block-level replaced elements in normal flow, 'inline-block' replaced elements in normal flow and floating replaced elements	185
10.6.3 Block-level non-replaced elements in normal flow when 'overflow' computes to 'visible'	185
10.6.4 Absolutely positioned, non-replaced elements	186
10.6.5 Absolutely positioned, replaced elements	187
10.6.6 Complicated cases	187
10.6.7 'Auto' heights for block formatting context roots	188
10.7 Minimum and maximum heights: 'min-height' and 'max-height'	188
10.8 Line height calculations: the 'line-height' and 'vertical-align' properties	190
10.8.1 Leading and half-leading	190

10.1 Definition of "containing block"

The position and size of an element's box(es) are sometimes calculated relative to a certain rectangle, called the *containing block* of the element. The containing block of an element is defined as follows:

1. The containing block in which the root element [p. 45] lives is a rectangle called the *initial containing block*. For continuous media, it has the dimensions of the viewport [p. 128] and is anchored at the canvas origin; it is the page area

[p. 222] for paged media. The 'direction' property of the initial containing block is the same as for the root element.

2. For other elements, if the element's position is 'relative' or 'static', the containing block is formed by the content edge of the nearest block container [p. 129] ancestor box.
3. If the element has 'position: fixed', the containing block is established by the viewport [p. 128] in the case of continuous media or the page area in the case of paged media.
4. If the element has 'position: absolute', the containing block is established by the nearest ancestor with a 'position' of 'absolute', 'relative' or 'fixed', in the following way:
 1. In the case that the ancestor is an inline box, the containing block depends on the 'direction' property of the ancestor:
 1. If the 'direction' is 'ltr', the top and left of the containing block are the top and left padding edges of the first box generated by the ancestor, and the bottom and right are the bottom and right padding edges of the last box of the ancestor.
 2. If the 'direction' is 'rtl', the top and right are the top and right padding edges of the first box generated by the ancestor, and the bottom and left are the bottom and left padding edges of the last box of the ancestor.

Note: This may cause the containing block's width to be negative.

2. Otherwise, the containing block is formed by the padding edge [p. 112] of the ancestor.

If there is no such ancestor, the containing block is the initial containing block.

In paged media, an absolutely positioned element is positioned relative to its containing block ignoring any page breaks (as if the document were continuous). The element may subsequently be broken over several pages.

For absolutely positioned content that resolves to a position on a page other than the page being laid out (the current page), or resolves to a position on the current page which has already been rendered for printing, printers may place the content

- on another location on the current page,
- on a subsequent page, or
- may omit it.

Note that a block-level element that is split over several pages may have a different width on each page and that there may be device-specific limits.

Example(s):

With no positioning, the containing blocks (C.B.) in the following document:

```
<!DOCTYPE HTML PUBLIC "-//W3C//DTD HTML 4.01//EN">
<HTML>
  <HEAD>
    <TITLE>Illustration of containing blocks</TITLE>
  </HEAD>
  <BODY id="body">
    <DIV id="div1">
      <P id="p1">This is text in the first paragraph...</P>
      <P id="p2">This is text <EM id="em1"> in the
      <STRONG id="strong1">second</STRONG> paragraph.</EM></P>
    </DIV>
  </BODY>
</HTML>
```

are established as follows:

For box generated by	C.B. is established by
html	initial C.B. (UA-dependent)
body	html
div1	body
p1	div1
p2	div1
em1	p2
strong1	p2

If we position "div1":

```
#div1 { position: absolute; left: 50px; top: 50px }
```

its containing block is no longer "body"; it becomes the initial containing block (since there are no other positioned ancestor boxes).

If we position "em1" as well:

```
#div1 { position: absolute; left: 50px; top: 50px }
#em1 { position: absolute; left: 100px; top: 100px }
```

the table of containing blocks becomes:

For box generated by	C.B. is established by
html	initial C.B. (UA-dependent)
body	html
div1	initial C.B.
p1	div1
p2	div1
em1	div1
strong1	em1

By positioning "em1", its containing block becomes the nearest positioned ancestor box (i.e., that generated by "div1").

10.2 Content width: the 'width' property

'width'

<i>Value:</i>	<length> <percentage> auto inherit
<i>Initial:</i>	auto
<i>Applies to:</i>	all elements but non-replaced inline elements, table rows, and row groups
<i>Inherited:</i>	no
<i>Percentages:</i>	refer to width of containing block
<i>Media:</i>	visual
<i>Computed value:</i>	the percentage or 'auto' as specified or the absolute length

This property specifies the content width [p. 113] of boxes.

This property does not apply to non-replaced inline [p. 131] elements. The content width of a non-replaced inline element's boxes is that of the rendered content within them (*before* any relative offset of children). Recall that inline boxes flow into line boxes [p. 139]. The width of line boxes is given by their containing block [p. 128], but may be shorted by the presence of floats [p. 143].

Values have the following meanings:

<length>

Specifies the width of the content area using a length unit.

<percentage>

Specifies a percentage width. The percentage is calculated with respect to the width of the generated box's containing block [p. 128]. If the containing block's width depends on this element's width, then the resulting layout is undefined in CSS 2.1. Note: For absolutely positioned elements whose containing block is

based on a block-level element, the percentage is calculated with respect to the width of the *padding box* of that element. This is a change from CSS1, where the percentage width was always calculated with respect to the *content box* of the parent element.

auto

The width depends on the values of other properties. See the sections below.

Negative values for 'width' are illegal.

Example(s):

For example, the following rule fixes the content width of paragraphs at 100 pixels:

```
p { width: 100px }
```

10.3 Calculating widths and margins

The values of an element's 'width', 'margin-left', 'margin-right', 'left' and 'right' properties as used for layout depend on the type of box generated and on each other. (The value used for layout is sometimes referred to as the used value [p. 100] .) In principle, the values used are the same as the computed values, with 'auto' replaced by some suitable value, and percentages calculated based on the containing block, but there are exceptions. The following situations need to be distinguished:

1. inline, non-replaced elements
2. inline, replaced elements
3. block-level, non-replaced elements in normal flow
4. block-level, replaced elements in normal flow
5. floating, non-replaced elements
6. floating, replaced elements
7. absolutely positioned, non-replaced elements
8. absolutely positioned, replaced elements
9. 'inline-block', non-replaced elements in normal flow
10. 'inline-block', replaced elements in normal flow

For Points 1-6 and 9-10, the values of 'left' and 'right' in the case of relatively positioned elements are determined by the rules in section 9.4.3. [p. 142]

10.3.1 Inline, non-replaced elements

The 'width' property does not apply. A computed value of 'auto' for 'margin-left' or 'margin-right' becomes a used value of '0'.

10.3.2 Inline, replaced elements

A computed value of 'auto' for 'margin-left' or 'margin-right' becomes a used value of '0'.

If 'height' and 'width' both have computed values of 'auto' and the element also has an intrinsic width, then that intrinsic width is the used value of 'width'.

If 'height' and 'width' both have computed values of 'auto' and the element has no intrinsic width, but does have an intrinsic height and intrinsic ratio; or if 'width' has a computed value of 'auto', 'height' has some other computed value, and the element does have an intrinsic ratio; then the used value of 'width' is:

$$(\text{used height}) * (\text{intrinsic ratio})$$

If 'height' and 'width' both have computed values of 'auto' and the element has an intrinsic ratio but no intrinsic height or width and the containing block's width does not itself depend on the replaced element's width, then the used value of 'width' is calculated from the constraint equation used for block-level, non-replaced elements in normal flow.

Otherwise, if 'width' has a computed value of 'auto', and the element has an intrinsic width, then that intrinsic width is the used value of 'width'.

Otherwise, if 'width' has a computed value of 'auto', but none of the conditions above are met, then the used value of 'width' becomes 300px. If 300px is too wide to fit the device, UAs should use the width of the largest rectangle that has a 2:1 ratio and fits the device instead.

Percentage intrinsic widths are first evaluated with respect to the containing block's width, if that width does not itself depend on the replaced element's width. If it does, then the resulting layout is undefined in CSS 2.1.

10.3.3 Block-level, non-replaced elements in normal flow

The following constraints must hold among the used values of the other properties:

$$'margin-left' + 'border-left-width' + 'padding-left' + 'width' + 'padding-right' + 'border-right-width' + 'margin-right' = \text{width of containing block [p. 171]}$$

If 'width' is not 'auto' and 'border-left-width' + 'padding-left' + 'width' + 'padding-right' + 'border-right-width' (plus any of 'margin-left' or 'margin-right' that are not 'auto') is larger than the width of the containing block, then any 'auto' values for 'margin-left' or 'margin-right' are, for the following rules, treated as zero.

If all of the above have a computed value other than 'auto', the values are said to be "over-constrained" and one of the used values will have to be different from its computed value. If the 'direction' property of the containing block has the value 'ltr', the specified value of 'margin-right' is ignored and the value is calculated so as to make the equality true. If the value of 'direction' is 'rtl', this happens to 'margin-left' instead.

If there is exactly one value specified as 'auto', its used value follows from the equality.

If 'width' is set to 'auto', any other 'auto' values become '0' and 'width' follows from the resulting equality.

If both 'margin-left' and 'margin-right' are 'auto', their used values are equal. This horizontally centers the element with respect to the edges of the containing block.

10.3.4 Block-level, replaced elements in normal flow

The used value of 'width' is determined as for inline replaced elements [p. 176] . Then the rules for non-replaced block-level elements [p. 176] are applied to determine the margins.

10.3.5 Floating, non-replaced elements

If 'margin-left', or 'margin-right' are computed as 'auto', their used value is '0'.

If 'width' is computed as 'auto', the used value is the "shrink-to-fit" width.

Calculation of the shrink-to-fit width is similar to calculating the width of a table cell using the automatic table layout algorithm. Roughly: calculate the preferred width by formatting the content without breaking lines other than where explicit line breaks occur, and also calculate the preferred *minimum* width, e.g., by trying all possible line breaks. CSS 2.1 does not define the exact algorithm. Thirdly, find the *available width*: in this case, this is the width of the containing block minus the used values of 'margin-left', 'border-left-width', 'padding-left', 'padding-right', 'border-right-width', 'margin-right', and the widths of any relevant scroll bars.

Then the shrink-to-fit width is: $\min(\max(\text{preferred minimum width}, \text{available width}), \text{preferred width})$.

10.3.6 Floating, replaced elements

If 'margin-left' or 'margin-right' are computed as 'auto', their used value is '0'. The used value of 'width' is determined as for inline replaced elements [p. 176] .

10.3.7 Absolutely positioned, non-replaced elements

For the purposes of this section and the next, the term "static position" (of an element) refers, roughly, to the position an element would have had in the normal flow. More precisely:

- The *static-position containing block* is the containing block of a hypothetical box that would have been the first box of the element if its specified 'position' value had been 'static' and its specified 'float' had been 'none'. (Note that due to the rules in section 9.7 [p. 154] this hypothetical calculation might require also assuming a different computed value for 'display'.)
- The static position for 'left' is the distance from the left edge of the containing

block to the left margin edge of a hypothetical box that would have been the first box of the element if its 'position' property had been 'static' and 'float' had been 'none'. The value is negative if the hypothetical box is to the left of the containing block.

- The static position for 'right' is the distance from the right edge of the containing block to the right margin edge of the same hypothetical box as above. The value is positive if the hypothetical box is to the left of the containing block's edge.

But rather than actually calculating the dimensions of that hypothetical box, user agents are free to make a guess at its probable position.

For the purposes of calculating the static position, the containing block of fixed positioned elements is the initial containing block instead of the viewport, and all scrollable boxes should be assumed to be scrolled to their origin.

The constraint that determines the used values for these elements is:

$$\text{'left' + 'margin-left' + 'border-left-width' + 'padding-left' + 'width' + 'padding-right' + 'border-right-width' + 'margin-right' + 'right' = width of containing block}$$

If all three of 'left', 'width', and 'right' are 'auto': First set any 'auto' values for 'margin-left' and 'margin-right' to 0. Then, if the 'direction' property of the element establishing the static-position containing block is 'ltr' set 'left' to the static position [p. 177] and apply rule number three below; otherwise, set 'right' to the static position [p. 177] and apply rule number one below.

If none of the three is 'auto': If both 'margin-left' and 'margin-right' are 'auto', solve the equation under the extra constraint that the two margins get equal values, unless this would make them negative, in which case when direction of the containing block is 'ltr' ('rtl'), set 'margin-left' ('margin-right') to zero and solve for 'margin-right' ('margin-left'). If one of 'margin-left' or 'margin-right' is 'auto', solve the equation for that value. If the values are over-constrained, ignore the value for 'left' (in case the 'direction' property of the containing block is 'rtl') or 'right' (in case 'direction' is 'ltr') and solve for that value.

Otherwise, set 'auto' values for 'margin-left' and 'margin-right' to 0, and pick the one of the following six rules that applies.

1. 'left' and 'width' are 'auto' and 'right' is not 'auto', then the width is shrink-to-fit. Then solve for 'left'
2. 'left' and 'right' are 'auto' and 'width' is not 'auto', then if the 'direction' property of the element establishing the static-position containing block is 'ltr' set 'left' to the static position [p. 177], otherwise set 'right' to the static position [p. 177]. Then solve for 'left' (if 'direction' is 'rtl') or 'right' (if 'direction' is 'ltr').
3. 'width' and 'right' are 'auto' and 'left' is not 'auto', then the width is shrink-to-fit. Then solve for 'right'
4. 'left' is 'auto', 'width' and 'right' are not 'auto', then solve for 'left'
5. 'width' is 'auto', 'left' and 'right' are not 'auto', then solve for 'width'

6. 'right' is 'auto', 'left' and 'width' are not 'auto', then solve for 'right'

Calculation of the shrink-to-fit width is similar to calculating the width of a table cell using the automatic table layout algorithm. Roughly: calculate the preferred width by formatting the content without breaking lines other than where explicit line breaks occur, and also calculate the preferred *minimum* width, e.g., by trying all possible line breaks. CSS 2.1 does not define the exact algorithm. Thirdly, calculate the *available width*: this is found by solving for 'width' after setting 'left' (in case 1) or 'right' (in case 3) to 0.

Then the shrink-to-fit width is: $\min(\max(\text{preferred minimum width}, \text{available width}), \text{preferred width})$.

10.3.8 Absolutely positioned, replaced elements

In this case, section 10.3.7 [p. 177] applies up through and including the constraint equation, but the rest of section 10.3.7 [p. 177] is replaced by the following rules:

1. The used value of 'width' is determined as for inline replaced elements [p. 176]. If 'margin-left' or 'margin-right' is specified as 'auto' its used value is determined by the rules below.
2. If both 'left' and 'right' have the value 'auto', then if the 'direction' property of the element establishing the static-position containing block is 'ltr', set 'left' to the static position; else if 'direction' is 'rtl', set 'right' to the static position.
3. If 'left' or 'right' are 'auto', replace any 'auto' on 'margin-left' or 'margin-right' with '0'.
4. If at this point both 'margin-left' and 'margin-right' are still 'auto', solve the equation under the extra constraint that the two margins must get equal values, unless this would make them negative, in which case when the direction of the containing block is 'ltr' ('rtl'), set 'margin-left' ('margin-right') to zero and solve for 'margin-right' ('margin-left').
5. If at this point there is an 'auto' left, solve the equation for that value.
6. If at this point the values are over-constrained, ignore the value for either 'left' (in case the 'direction' property of the containing block is 'rtl') or 'right' (in case 'direction' is 'ltr') and solve for that value.

10.3.9 'Inline-block', non-replaced elements in normal flow

If 'width' is 'auto', the used value is the shrink-to-fit [p. 177] width as for floating elements.

A computed value of 'auto' for 'margin-left' or 'margin-right' becomes a used value of '0'.

10.3.10 'Inline-block', replaced elements in normal flow

Exactly as inline replaced elements. [p. 176]

10.4 Minimum and maximum widths: 'min-width' and 'max-width'

'min-width'

<i>Value:</i>	<length> <percentage> inherit
<i>Initial:</i>	0
<i>Applies to:</i>	all elements but non-replaced inline elements, table rows, and row groups
<i>Inherited:</i>	no
<i>Percentages:</i>	refer to width of containing block
<i>Media:</i>	visual
<i>Computed value:</i>	the percentage as specified or the absolute length

'max-width'

<i>Value:</i>	<length> <percentage> none inherit
<i>Initial:</i>	none
<i>Applies to:</i>	all elements but non-replaced inline elements, table rows, and row groups
<i>Inherited:</i>	no
<i>Percentages:</i>	refer to width of containing block
<i>Media:</i>	visual
<i>Computed value:</i>	the percentage as specified or the absolute length or 'none'

These two properties allow authors to constrain content widths to a certain range. Values have the following meanings:

<length>

Specifies a fixed minimum or maximum used width.

<percentage>

Specifies a percentage for determining the used value. The percentage is calculated with respect to the width of the generated box's containing block [p. 128]. If the containing block's width is negative, the used value is zero. If the containing block's width depends on this element's width, then the resulting layout is undefined in CSS 2.1.

none

(Only on 'max-width') No limit on the width of the box.

Negative values for 'min-width' and 'max-width' are illegal.

The following algorithm describes how the two properties influence the used value [p. 100] of the 'width' property:

1. The tentative used width is calculated (without 'min-width' and 'max-width') following the rules under "Calculating widths and margins" [p. 175] above.
2. If the tentative used width is greater than 'max-width', the rules above [p. 175] are applied again, but this time using the computed value of 'max-width' as the computed value for 'width'.
3. If the resulting width is smaller than 'min-width', the rules above [p. 175] are applied again, but this time using the value of 'min-width' as the computed value for 'width'.

These steps do not affect the real computed values of the above properties.

However, for replaced elements with an intrinsic ratio and both 'width' and 'height' specified as 'auto', the algorithm is as follows:

Select from the table the resolved height and width values for the appropriate constraint violation. Take the *max-width* and *max-height* as $\max(\min, \max)$ so that $\min \leq \max$ holds true. In this table *w* and *h* stand for the results of the width and height computations ignoring the 'min-width', 'min-height', 'max-width' and 'max-height' properties. Normally these are the intrinsic width and height, but they may not be in the case of replaced elements with intrinsic ratios.

Note: In cases where an explicit width or height is set and the other dimension is auto, applying a minimum or maximum constraint on the auto side can cause an over-constrained situation. The spec is clear in the behavior but it might not be what the author expects. The CSS3 object-fit property can be used to obtain different results in this situation.

Constraint Violation	Resolved Width	Resolved Height
none	w	h
$w > \text{max-width}$	max-width	$\text{max}(\text{max-width} * h/w, \text{min-height})$
$w < \text{min-width}$	min-width	$\text{min}(\text{min-width} * h/w, \text{max-height})$
$h > \text{max-height}$	$\text{max}(\text{max-height} * w/h, \text{min-width})$	max-height
$h < \text{min-height}$	$\text{min}(\text{min-height} * w/h, \text{max-width})$	min-height
$(w > \text{max-width})$ and $(h > \text{max-height})$, where $(\text{max-width}/w \leq \text{max-height}/h)$	max-width	$\text{max}(\text{min-height}, \text{max-width} * h/w)$
$(w > \text{max-width})$ and $(h > \text{max-height})$, where $(\text{max-width}/w > \text{max-height}/h)$	$\text{max}(\text{min-width}, \text{max-height} * w/h)$	max-height
$(w < \text{min-width})$ and $(h < \text{min-height})$, where $(\text{min-width}/w \leq \text{min-height}/h)$	$\text{min}(\text{max-width}, \text{min-height} * w/h)$	min-height
$(w < \text{min-width})$ and $(h < \text{min-height})$, where $(\text{min-width}/w > \text{min-height}/h)$	min-width	$\text{min}(\text{max-height}, \text{min-width} * h/w)$
$(w < \text{min-width})$ and $(h > \text{max-height})$	min-width	max-height
$(w > \text{max-width})$ and $(h < \text{min-height})$	max-width	min-height

Then apply the rules under "Calculating widths and margins" [p. 175] above, as if 'width' were computed as this value.

10.5 Content height: the 'height' property

'height'

<i>Value:</i>	<length> <percentage> auto inherit
<i>Initial:</i>	auto
<i>Applies to:</i>	all elements but non-replaced inline elements, table columns, and column groups
<i>Inherited:</i>	no
<i>Percentages:</i>	see prose
<i>Media:</i>	visual
<i>Computed value:</i>	the percentage or 'auto' (see prose under <percentage>) or the absolute length

This property specifies the content height [p. 113] of boxes.

This property does not apply to non-replaced inline [p. 131] elements. See the section on computing heights and margins for non-replaced inline elements [p. 184] for the rules used instead.

Values have the following meanings:

<length>

Specifies the height of the content area using a length value.

<percentage>

Specifies a percentage height. The percentage is calculated with respect to the height of the generated box's containing block [p. 128]. If the height of the containing block is not specified explicitly (i.e., it depends on content height), and this element is not absolutely positioned, the value computes to 'auto'. A percentage height on the root element [p. 45] is relative to the initial containing block [p. 171]. Note: For absolutely positioned elements whose containing block is based on a block-level element, the percentage is calculated with respect to the height of the *padding box* of that element. This is a change from CSS1, where the percentage was always calculated with respect to the *content box* of the parent element.

auto

The height depends on the values of other properties. See the prose below.

Note that the height of the containing block of an absolutely positioned element is independent of the size of the element itself, and thus a percentage height on such an element can always be resolved. However, it may be that the height is not known until elements that come later in the document have been processed.

Negative values for 'height' are illegal.

Example(s):

For example, the following rule sets the content height of paragraphs to 100 pixels:

```
p { height: 100px }
```

Paragraphs of which the height of the contents exceeds 100 pixels will overflow [p. 195] according to the 'overflow' property.

10.6 Calculating heights and margins

For calculating the values of 'top', 'margin-top', 'height', 'margin-bottom', and 'bottom' a distinction must be made between various kinds of boxes:

1. inline, non-replaced elements
2. inline, replaced elements
3. block-level, non-replaced elements in normal flow
4. block-level, replaced elements in normal flow
5. floating, non-replaced elements
6. floating, replaced elements
7. absolutely positioned, non-replaced elements
8. absolutely positioned, replaced elements
9. 'inline-block', non-replaced elements in normal flow
10. 'inline-block', replaced elements in normal flow

For Points 1-6 and 9-10, the used values of 'top' and 'bottom' are determined by the rules in section 9.4.3.

Note: these rules apply to the root element just as to any other element.

10.6.1 Inline, non-replaced elements

The 'height' property does not apply. The height of the content area should be based on the font, but this specification does not specify how. A UA may, e.g., use the em-box or the maximum ascender and descender of the font. (The latter would ensure that glyphs with parts above or below the em-box still fall within the content area, but leads to differently sized boxes for different fonts; the former would ensure authors can control background styling relative to the 'line-height', but leads to glyphs painting outside their content area.)

Note: level 3 of CSS will probably include a property to select which measure of the font is used for the content height.

The vertical padding, border and margin of an inline, non-replaced box start at the top and bottom of the content area, not the 'line-height'. But only the 'line-height' is used when calculating the height of the line box.

If more than one font is used (this could happen when glyphs are found in different fonts), the height of the content area is not defined by this specification. However, we suggest that the height is chosen such that the content area is just high enough for either (1) the em-boxes, or (2) the maximum ascenders and descenders, of *all* the fonts in the element. Note that this may be larger than any of the font sizes involved, depending on the baseline alignment of the fonts.

10.6.2 Inline replaced elements, block-level replaced elements in normal flow, 'inline-block' replaced elements in normal flow and floating replaced elements

If 'margin-top', or 'margin-bottom' are 'auto', their used value is 0.

If 'height' and 'width' both have computed values of 'auto' and the element also has an intrinsic height, then that intrinsic height is the used value of 'height'.

Otherwise, if 'height' has a computed value of 'auto', and the element has an intrinsic ratio then the used value of 'height' is:

$$(\text{used width}) / (\text{intrinsic ratio})$$

Otherwise, if 'height' has a computed value of 'auto', and the element has an intrinsic height, then that intrinsic height is the used value of 'height'.

Otherwise, if 'height' has a computed value of 'auto', but none of the conditions above are met, then the used value of 'height' must be set to the height of the largest rectangle that has a 2:1 ratio, has a height not greater than 150px, and has a width not greater than the device width.

Percentage intrinsic heights are evaluated with respect to the containing block's height, if that height is specified explicitly, or if the replaced element is absolutely positioned. If neither of these conditions is met, then percentage values on such replaced elements cannot be resolved and such elements are assumed to have no intrinsic height.

For 'inline' and 'inline-block' elements, the margin box is used when calculating the height of the line box.

10.6.3 Block-level non-replaced elements in normal flow when 'overflow' computes to 'visible'

This section also applies to block-level non-replaced elements in normal flow when 'overflow' does not compute to 'visible' but has been propagated to the viewport.

If 'margin-top', or 'margin-bottom' are 'auto', their used value is 0. If 'height' is 'auto', the height depends on whether the element has any block-level children and whether it has padding or borders:

If it only has inline-level children, the height is the distance between the top of the topmost line box and the bottom of the bottommost line box.

If it has block-level children, the height is the distance between the top border-edge of the topmost block-level child box that does not have margins collapsed through it [p. 117] and the bottom border-edge of the bottommost block-level child box that does not have margins collapsed through it. However, if the element has a non-zero top padding and/or top border, or is the root element, then the content starts at the top *margin* edge of the topmost child. (The first case expresses the fact that the top and bottom margins of the element collapse [p. 117])

with those of the topmost and bottommost children, while in the second case the presence of the padding/border prevents the top margins from collapsing [p. 117] .) Similarly, if the bottom margin of the block does not collapse with the bottom margin of its last in-flow child, then the content ends at the bottom margin edge of the bottommost child.

Only children in the normal flow are taken into account (i.e., floating boxes and absolutely positioned boxes are ignored, and relatively positioned boxes are considered without their offset). Note that the child box may be an anonymous block box. [p. 129]

10.6.4 Absolutely positioned, non-replaced elements

For the purposes of this section and the next, the term "static position" (of an element) refers, roughly, to the position an element would have had in the normal flow. More precisely, the static position for 'top' is the distance from the top edge of the containing block to the top margin edge of a hypothetical box that would have been the first box of the element if its specified 'position' value had been 'static' and its specified 'float' had been 'none' and its specified 'clear' had been 'none'. (Note that due to the rules in section 9.7 [p. 154] this might require also assuming a different computed value for 'display'.) The value is negative if the hypothetical box is above the containing block.

But rather than actually calculating the dimensions of that hypothetical box, user agents are free to make a guess at its probable position.

For the purposes of calculating the static position, the containing block of fixed positioned elements is the initial containing block instead of the viewport.

For absolutely positioned elements, the used values of the vertical dimensions must satisfy this constraint:

$$\text{'top'} + \text{'margin-top'} + \text{'border-top-width'} + \text{'padding-top'} + \text{'height'} + \text{'padding-bottom'} + \text{'border-bottom-width'} + \text{'margin-bottom'} + \text{'bottom'} = \text{height of containing block}$$

If all three of 'top', 'height', and 'bottom' are auto, set 'top' to the static position and apply rule number three below.

If none of the three are 'auto': If both 'margin-top' and 'margin-bottom' are 'auto', solve the equation under the extra constraint that the two margins get equal values. If one of 'margin-top' or 'margin-bottom' is 'auto', solve the equation for that value. If the values are over-constrained, ignore the value for 'bottom' and solve for that value.

Otherwise, pick the one of the following six rules that applies.

1. 'top' and 'height' are 'auto' and 'bottom' is not 'auto', then the height is based on the content per 10.6.7 [p. 188] , set 'auto' values for 'margin-top' and 'margin-bottom' to 0, and solve for 'top'
2. 'top' and 'bottom' are 'auto' and 'height' is not 'auto', then set 'top' to the static

position, set 'auto' values for 'margin-top' and 'margin-bottom' to 0, and solve for 'bottom'

3. 'height' and 'bottom' are 'auto' and 'top' is not 'auto', then the height is based on the content per 10.6.7 [p. 188] , set 'auto' values for 'margin-top' and 'margin-bottom' to 0, and solve for 'bottom'
4. 'top' is 'auto', 'height' and 'bottom' are not 'auto', then set 'auto' values for 'margin-top' and 'margin-bottom' to 0, and solve for 'top'
5. 'height' is 'auto', 'top' and 'bottom' are not 'auto', then 'auto' values for 'margin-top' and 'margin-bottom' are set to 0 and solve for 'height'
6. 'bottom' is 'auto', 'top' and 'height' are not 'auto', then set 'auto' values for 'margin-top' and 'margin-bottom' to 0 and solve for 'bottom'

10.6.5 Absolutely positioned, replaced elements

This situation is similar to the previous one, except that the element has an intrinsic [p. 45] height. The sequence of substitutions is now:

1. The used value of 'height' is determined as for inline replaced elements [p. 185] . If 'margin-top' or 'margin-bottom' is specified as 'auto' its used value is determined by the rules below.
2. If both 'top' and 'bottom' have the value 'auto', replace 'top' with the element's static position [p. 177] .
3. If 'bottom' is 'auto', replace any 'auto' on 'margin-top' or 'margin-bottom' with '0'.
4. If at this point both 'margin-top' and 'margin-bottom' are still 'auto', solve the equation under the extra constraint that the two margins must get equal values.
5. If at this point there is only one 'auto' left, solve the equation for that value.
6. If at this point the values are over-constrained, ignore the value for 'bottom' and solve for that value.

10.6.6 Complicated cases

This section applies to:

- Block-level, non-replaced elements in normal flow when 'overflow' does not compute to 'visible' (except if the 'overflow' property's value has been propagated to the viewport).
- 'Inline-block', non-replaced elements.
- Floating, non-replaced elements.

If 'margin-top', or 'margin-bottom' are 'auto', their used value is 0. If 'height' is 'auto', the height depends on the element's descendants per 10.6.7 [p. 188] .

For 'inline-block' elements, the margin box is used when calculating the height of the line box.

10.6.7 'Auto' heights for block formatting context roots

In certain cases (see, e.g., sections 10.6.4 [p. 186] and 10.6.6 [p. 187] above), the height of an element that establishes a block formatting context is computed as follows:

If it only has inline-level children, the height is the distance between the top of the topmost line box and the bottom of the bottommost line box.

If it has block-level children, the height is the distance between the top margin-edge of the topmost block-level child box and the bottom margin-edge of the bottommost block-level child box.

Absolutely positioned children are ignored, and relatively positioned boxes are considered without their offset. Note that the child box may be an anonymous block box. [p. 129]

In addition, if the element has any floating descendants whose bottom margin edge is below the element's bottom content edge, then the height is increased to include those edges. Only floats that participate in this block formatting context are taken into account, e.g., floats inside absolutely positioned descendants or other floats are not.

10.7 Minimum and maximum heights: 'min-height' and 'max-height'

It is sometimes useful to constrain the height of elements to a certain range. Two properties offer this functionality:

'min-height'

<i>Value:</i>	<length> <percentage> inherit
<i>Initial:</i>	0
<i>Applies to:</i>	all elements but non-replaced inline elements, table columns, and column groups
<i>Inherited:</i>	no
<i>Percentages:</i>	see prose
<i>Media:</i>	visual
<i>Computed value:</i>	the percentage as specified or the absolute length

'max-height'

<i>Value:</i>	<length> <percentage> none inherit
<i>Initial:</i>	none
<i>Applies to:</i>	all elements but non-replaced inline elements, table columns, and column groups
<i>Inherited:</i>	no
<i>Percentages:</i>	see prose
<i>Media:</i>	visual
<i>Computed value:</i>	the percentage as specified or the absolute length or 'none'

These two properties allow authors to constrain box heights to a certain range. Values have the following meanings:

<length>

Specifies a fixed minimum or maximum computed height.

<percentage>

Specifies a percentage for determining the used value. The percentage is calculated with respect to the height of the generated box's containing block [p. 128]. If the height of the containing block is not specified explicitly (i.e., it depends on content height), and this element is not absolutely positioned, the percentage value is treated as '0' (for 'min-height') or 'none' (for 'max-height').

none

(Only on 'max-height') No limit on the height of the box.

Negative values for 'min-height' and 'max-height' are illegal.

In CSS 2.1, the effect of 'min-height' and 'max-height' on table cells, table rows, and row groups is undefined.

The following algorithm describes how the two properties influence the used value [p. 100] of the 'height' property:

1. The tentative used height is calculated (without 'min-height' and 'max-height') following the rules under "Calculating heights and margins" [p. 184] above.
2. If this tentative height is greater than 'max-height', the rules above [p. 184] are applied again, but this time using the value of 'max-height' as the computed value for 'height'.
3. If the resulting height is smaller than 'min-height', the rules above [p. 184] are applied again, but this time using the value of 'min-height' as the computed value for 'height'.

These steps do not affect the real computed values of the above properties. The change of used 'height' has no effect on margin collapsing except as specifically required by rules for 'min-height' or 'max-height' in "Collapsing margins" (8.3.1). [p. 117]

However, for replaced elements with both 'width' and 'height' computed as 'auto', use the algorithm under Minimum and maximum widths [p. 180] above to find the used width and height. Then apply the rules under "Computing heights and margins" [p. 184] above, using the resulting width and height as if they were the computed

values.

10.8 Line height calculations: the 'line-height' and 'vertical-align' properties

As described in the section on inline formatting contexts [p. 139], user agents flow inline-level boxes into a vertical stack of line boxes [p. 139]. The height of a line box is determined as follows:

1. The height of each inline-level box in the line box is calculated (see "Calculating heights and margins" [p. 184] and the 'line-height' property).
2. The inline-level boxes are aligned vertically according to their 'vertical-align' property. In case they are aligned 'top' or 'bottom', they must be aligned so as to minimize the line box height. If such boxes are tall enough, there are multiple solutions and CSS 2.1 does not define the position of the line box's baseline (i.e., the position of the strut, see below [p. 191]).
3. The line box height is the distance between the uppermost box top and the lowermost box bottom. (This includes the strut, [p. 191] as explained under 'line-height' below.)

Empty inline elements generate empty inline boxes, but these boxes still have margins, padding, borders and a line height, and thus influence these calculations just like elements with content.

10.8.1 Leading and half-leading

CSS assumes that every font has font metrics that specify a characteristic height above the baseline and a depth below it. In this section we use A to mean that height (for a given font at a given size) and D the depth. We also define $AD = A + D$, the distance from the top to the bottom. (See the note below for how to find A and D for TrueType and OpenType fonts. [p. ??]) Note that these are metrics of the font as a whole and need not correspond to the ascender and descender of any individual glyph.

User agent must align the glyphs in a non-replaced inline box to each other by their relevant baselines, and to nested inline boxes according to 'vertical-align'. Then, for each glyph, determine the A and D . Note that glyphs in a single element may come from different fonts and thus need not all have the same A and D . If the inline box contains no glyphs at all, it is considered to contain a strut [p. 191] (an invisible glyph of zero width) with the A and D of the element's first available font.

Still for each glyph, determine the leading L to add, where $L = \text{line-height} - AD$. Half the leading is added above A and the other half below D , giving the glyph and its leading a total height above the baseline of $A' = A + L/2$ and a total depth of $D' = D + L/2$.

The height of the inline box is then the smallest such that it encloses all glyphs and their leading, as well as all nested inline boxes.

Although margins, borders, and padding of non-replaced elements do not enter into the line box calculation, they are still rendered around inline boxes. This means that if the height specified by 'line-height' is less than the content height of contained boxes, backgrounds and colors of padding and borders may "bleed" into adjoining line boxes. User agents should render the boxes in document order. This will cause the borders on subsequent lines to paint over the borders and text of previous lines.

Note. *CSS 2.1 does not define what the content area of an inline box is (see 10.6.1 [p. 184] above) and thus different UAs may draw the backgrounds and borders in different places.*

Note. *It is recommended that implementations that use OpenType or TrueType fonts use the metrics "sTypoAscender" and "sTypoDescender" from the font's OS/2 table for A and D (after scaling to the current element's font size). In the absence of these metrics, the "Ascent" and "Descent" metrics from the HHEA table should be used.*

'line-height'

<i>Value:</i>	normal <number> <length> <percentage> inherit
<i>Initial:</i>	normal
<i>Applies to:</i>	all elements
<i>Inherited:</i>	yes
<i>Percentages:</i>	refer to the font size of the element itself
<i>Media:</i>	visual
<i>Computed value:</i>	for <length> and <percentage> the absolute value; otherwise as specified

On a block container element [p. ??] whose content is composed of inline-level [p. 131] elements, 'line-height' specifies the *minimal* height of line boxes within the element. The minimum height consists of a minimum height above the baseline and a minimum depth below it, exactly as if each line box starts with a zero-width inline box with the element's font and line height properties. We call that imaginary box a "strut." (The name is inspired by TeX.).

The height and depth of the font above and below the baseline are assumed to be metrics that are contained in the font. (For more details, see CSS level 3.)

On an inline-level [p. 131] element, 'line-height' specifies the height that is used in the calculation of the line box height (except for inline replaced [p. 44] elements, where the height of the box is given by the 'height' property).

Values for this property have the following meanings:

normal

Tells user agents to set the used value to a "reasonable" value based on the font of the element. The value has the same meaning as <number>. We recom-

mend a used value for 'normal' between 1.0 to 1.2. The computed value [p. 100] is 'normal'.

<length>

The specified length is used in the calculation of the line box height. Negative values are illegal.

<number>

The used value of the property is this number multiplied by the element's font size. Negative values are illegal. The computed value [p. 100] is the same as the specified value.

<percentage>

The computed value [p. 100] of the property is this percentage multiplied by the element's computed font size. Negative values are illegal.

Example(s):

The three rules in the example below have the same resultant line height:

```
div { line-height: 1.2; font-size: 10pt }    /* number */
div { line-height: 1.2em; font-size: 10pt } /* length */
div { line-height: 120%; font-size: 10pt }  /* percentage */
```

When an element contains text that is rendered in more than one font, user agents may determine the 'normal' 'line-height' value according to the largest font size.

Generally, when there is only one value of 'line-height' for all inline boxes in a block-level box (and no replaced elements, inline-block elements, etc.), the above will ensure that baselines of successive lines are exactly 'line-height' apart. This is important when columns of text in different fonts have to be aligned, for example in a table.

'vertical-align'

<i>Value:</i>	baseline sub super top text-top middle bottom text-bottom <percentage> <length> inherit
<i>Initial:</i>	baseline
<i>Applies to:</i>	inline-level and 'table-cell' elements
<i>Inherited:</i>	no
<i>Percentages:</i>	refer to the 'line-height' of the element itself
<i>Media:</i>	visual
<i>Computed value:</i>	for <percentage> and <length> the absolute length, otherwise as specified

This property affects the vertical positioning inside a line box of the boxes generated by an inline-level element.

Note. Values of this property have different meanings in the context of tables. Please consult the section on table height algorithms [p. 285] for details.

The following values only have meaning with respect to a parent inline element, or to the strut [p. 191] of a parent block container element.

baseline

Align the baseline of the box with the baseline of the parent box. If the box does not have a baseline, align the bottom margin edge with the parent's baseline.

middle

Align the vertical midpoint of the box with the baseline of the parent box plus half the x-height of the parent.

sub

Lower the baseline of the box to the proper position for subscripts of the parent's box. (This value has no effect on the font size of the element's text.)

super

Raise the baseline of the box to the proper position for superscripts of the parent's box. (This value has no effect on the font size of the element's text.)

text-top

Align the top of the box with the top of the parent's content area (see 10.6.1 [p. 184]).

text-bottom

Align the bottom of the box with the bottom of the parent's content area (see 10.6.1 [p. 184]).

<percentage>

Raise (positive value) or lower (negative value) the box by this distance (a percentage of the 'line-height' value). The value '0%' means the same as 'baseline'.

<length>

Raise (positive value) or lower (negative value) the box by this distance. The value '0cm' means the same as 'baseline'.

The following values align the element relative to the line box. Since the element may have children aligned relative to it (which in turn may have descendants aligned relative to them), these values use the bounds of the aligned subtree. The *aligned subtree* of an inline element contains that element and the aligned subtrees of all children inline elements whose computed 'vertical-align' value is not 'top' or 'bottom'. The top of the aligned subtree is the highest of the tops of the boxes in the subtree, and the bottom is analogous.

top

Align the top of the aligned subtree with the top of the line box.

bottom

Align the bottom of the aligned subtree with the bottom of the line box.

The baseline of an 'inline-table' is the baseline of the first row of the table.

The baseline of an 'inline-block' is the baseline of its last line box in the normal flow, unless it has either no in-flow line boxes or its 'overflow' property has a computed value other than 'visible', in which case the baseline is the bottom margin edge.

11 Visual effects

Contents

11.1 Overflow and clipping	195
11.1.1 Overflow: the 'overflow' property	195
11.1.2 Clipping: the 'clip' property	198
11.2 Visibility: the 'visibility' property	201

11.1 Overflow and clipping

Generally, the content of a block box is confined to the content edges of the box. In certain cases, a box may *overflow*, meaning its content lies partly or entirely outside of the box, e.g.:

- A line cannot be broken, causing the line box to be wider than the block box.
- A block-level box is too wide for the containing block. This may happen when an element's 'width' property has a value that causes the generated block box to spill over sides of the containing block.
- An element's height exceeds an explicit height assigned to the containing block (i.e., the containing block's height is determined by the 'height' property, not by content height).
- A descendant box is positioned absolutely [p. 152] , partly outside the box. Such boxes are not always clipped by the overflow property on their ancestors; specifically, they are not clipped by the overflow of any ancestor between themselves and their containing block
- A descendant box has negative margins [p. 115] , causing it to be positioned partly outside the box.
- The 'text-indent' property causes an inline box to hang off either the left or right edge of the block box.

Whenever overflow occurs, the 'overflow' property specifies whether a box is clipped to its padding edge, and if so, whether a scrolling mechanism is provided to access any clipped out content.

11.1.1 Overflow: the 'overflow' property

'overflow'

<i>Value:</i>	visible hidden scroll auto inherit
<i>Initial:</i>	visible
<i>Applies to:</i>	non-replaced block-level elements, table cells, inline-table, and inline-block elements
<i>Inherited:</i>	no
<i>Percentages:</i>	N/A
<i>Media:</i>	visual
<i>Computed value:</i>	as specified

This property specifies whether content of a block container element is clipped when it overflows the element's box. It affects the clipping of all of the element's content except any descendant elements (and their respective content and descendants) whose containing block is the viewport or an ancestor of the element. Values have the following meanings:

visible

This value indicates that content is not clipped, i.e., it may be rendered outside the block box.

hidden

This value indicates that the content is clipped and that no scrolling user interface should be provided to view the content outside the clipping region.

scroll

This value indicates that the content is clipped and that if the user agent uses a scrolling mechanism that is visible on the screen (such as a scroll bar or a panner), that mechanism should be displayed for a box whether or not any of its content is clipped. This avoids any problem with scrollbars appearing and disappearing in a dynamic environment. When this value is specified and the target medium is 'print', overflowing content may be printed.

auto

The behavior of the 'auto' value is user agent-dependent, but should cause a scrolling mechanism to be provided for overflowing boxes.

Even if 'overflow' is set to 'visible', content may be clipped to a UA's document window by the native operating environment.

UAs must apply the 'overflow' property set on the root element to the viewport. When the root element is an HTML "HTML" element or an XHTML "html" element, and that element has an HTML "BODY" element or an XHTML "body" element as a child, user agents must instead apply the 'overflow' property from the first such child element to the viewport, if the value on the root element is 'visible'. The 'visible' value when used for the viewport must be interpreted as 'auto'. The element from which the value is propagated must have a used value for 'overflow' of 'visible'.

In the case of a scrollbar being placed on an edge of the element's box, it should be inserted between the inner border edge and the outer padding edge. Any space taken up by the scrollbars should be taken out of (subtracted from the dimensions of) the containing block formed by the element with the scrollbars.

Example(s):

Consider the following example of a block quotation (<blockquote>) that is too big for its containing block (established by a <div>). Here is the source:

```
<div>
<blockquote>
<p>I didn't like the play, but then I saw
it under adverse conditions - the curtain was up.</p>
<cite>- Groucho Marx</cite>
</blockquote>
</div>
```

Here is the style sheet controlling the sizes and style of the generated boxes:

```
div { width : 100px; height: 100px;
      border: thin solid red;
      }

blockquote { width : 125px; height : 100px;
            margin-top: 50px; margin-left: 50px;
            border: thin dashed black
            }

cite { display: block;
      text-align : right;
      border: none
      }
```

The initial value of 'overflow' is 'visible', so the <blockquote> would be formatted without clipping, something like this:

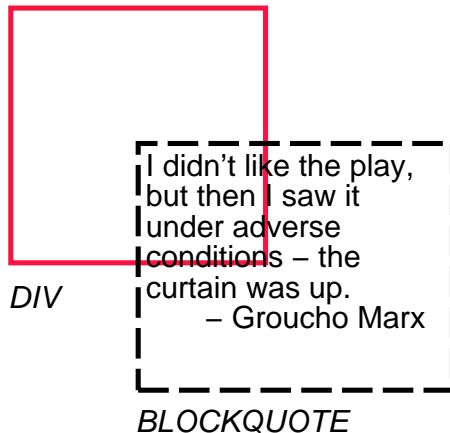

Setting 'overflow' to 'hidden' for the <div>, on the other hand, causes the <blockquote> to be clipped by the containing div:

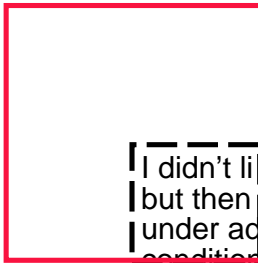

A value of 'scroll' would tell UAs that support a visible scrolling mechanism to display one so that users could access the clipped content.

Finally, consider this case where an absolutely positioned element is mixed with an overflow parent.

Style sheet:

```
container { position: relative; border: solid; }
scroller { overflow: scroll; height: 5em; margin: 5em; }
satellite { position: absolute; top: 0; }
body { height: 10em; }
```

Document fragment:

```
<container>
  <scroller>
    <satellite/>
  </scroller>
</container>
```

In this example, the "scroller" element will not scroll the "satellite" element, because the latter's containing block is outside the element whose overflow is being clipped and scrolled.

11.1.2 Clipping: the 'clip' property

A *clipping region* defines what portion of an element's border box is visible. By default, the element is not clipped. However, the clipping region may be explicitly set with the 'clip' property.

'clip'

<i>Value:</i>	<shape> auto inherit
<i>Initial:</i>	auto
<i>Applies to:</i>	absolutely positioned elements
<i>Inherited:</i>	no
<i>Percentages:</i>	N/A
<i>Media:</i>	visual
<i>Computed value:</i>	'auto' if specified as 'auto', otherwise a rectangle with four values, each of which is 'auto' if specified as 'auto' and the computed length otherwise

The 'clip' property applies only to absolutely positioned elements. Values have the following meanings:

auto

The element does not clip.

<shape>

In CSS 2.1, the only valid <shape> value is: rect(<top>, <right>, <bottom>, <left>) where <top> and <bottom> specify offsets from the top border edge of the box, and <right>, and <left> specify offsets from the left border edge of the box in left-to-right text and from the right border edge of the box in right-to-left text. Authors should separate offset values with commas. User agents must support separation with commas, but may also support separation without commas (but not a combination), because a previous revision of this specification was ambiguous in this respect.

<top>, <right>, <bottom>, and <left> may either have a <length> value or 'auto'. Negative lengths are permitted. The value 'auto' means that a given edge of the clipping region will be the same as the edge of the element's generated border box (i.e., 'auto' means the same as '0' for <top> and <left> (in left-to-right text, <right> in right-to-left text), the same as the used value of the height plus the sum of vertical padding and border widths for <bottom>, and the same as the used value of the width plus the sum of the horizontal padding and border widths for <right> (in left-to-right text, <left> in right-to-left text), such that four 'auto' values result in the clipping region being the same as the element's border box).

When coordinates are rounded to pixel coordinates, care should be taken that no pixels remain visible when <left> and <right> have the same value (or <top> and <bottom> have the same value), and conversely that no pixels within the element's border box remain hidden when these values are 'auto'.

An element's clipping region clips out any aspect of the element (e.g., content, children, background, borders, text decoration, outline and visible scrolling mechanism — if any) that is outside the clipping region. Content that has been clipped does not cause overflow.

The element's ancestors may also clip portions of their content (e.g., via their own 'clip' property and/or if their 'overflow' property is not 'visible'); what is rendered is the cumulative intersection.

If the clipping region exceeds the bounds of the UA's document window, content may be clipped to that window by the native operating environment.

Example(s):

The following two rules:

```
p { clip: rect(5px, 40px, 45px, 5px); }
p { clip: rect(5px, 55px, 45px, 5px); }
```

will create the rectangular clipping regions delimited by the dashed lines in the following illustrations:

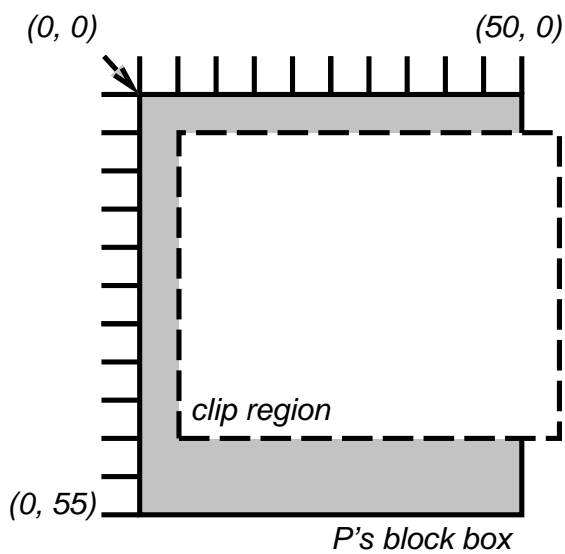
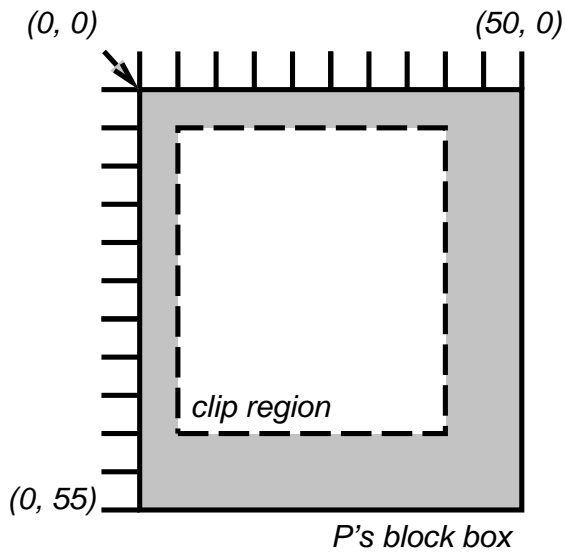

Note. In CSS 2.1, all clipping regions are rectangular. We anticipate future extensions to permit non-rectangular clipping. Future updates may also reintroduce a syntax for offsetting shapes from each edge instead of offsetting from a point.

11.2 Visibility: the 'visibility' property

'visibility'

<i>Value:</i>	visible hidden collapse inherit
<i>Initial:</i>	visible
<i>Applies to:</i>	all elements
<i>Inherited:</i>	yes
<i>Percentages:</i>	N/A
<i>Media:</i>	visual
<i>Computed value:</i>	as specified

The 'visibility' property specifies whether the boxes generated by an element are rendered. Invisible boxes still affect layout (set the 'display' property to 'none' to suppress box generation altogether). Values have the following meanings:

visible

The generated box is visible.

hidden

The generated box is invisible (fully transparent, nothing is drawn), but still affects layout. Furthermore, descendants of the element will be visible if they have 'visibility: visible'.

collapse

Please consult the section on dynamic row and column effects [p. 287] in tables. If used on elements other than rows, row groups, columns, or column groups, 'collapse' has the same meaning as 'hidden'.

This property may be used in conjunction with scripts to create dynamic effects.

In the following example, pressing either form button invokes an author-defined script function that causes the corresponding box to become visible and the other to be hidden. Since these boxes have the same size and position, the effect is that one replaces the other. (The script code is in a hypothetical script language. It may or may not have any effect in a CSS-capable UA.)

```
<!DOCTYPE HTML PUBLIC "-//W3C//DTD HTML 4.01//EN">
<HTML>
<HEAD><TITLE>Dynamic visibility example</TITLE>
<META
  http-equiv="Content-Script-Type"
  content="application/x-hypothetical-scripting-language">
<STYLE type="text/css">
<!--
  #container1 { position: absolute;
                top: 2in; left: 2in; width: 2in }
```

Visual effects

```
#container2 { position: absolute;
              top: 2in; left: 2in; width: 2in;
              visibility: hidden; }
-->
</STYLE>
</HEAD>
<BODY>
<P>Choose a suspect:</P>
<DIV id="container1">
  <IMG alt="Al Capone"
        width="100" height="100"
        src="suspect1.png">
  <P>Name: Al Capone</P>
  <P>Residence: Chicago</P>
</DIV>

<DIV id="container2">
  <IMG alt="Lucky Luciano"
        width="100" height="100"
        src="suspect2.png">
  <P>Name: Lucky Luciano</P>
  <P>Residence: New York</P>
</DIV>

<FORM method="post "
        action="http://www.suspect.org/process-bums">
  <P>
  <INPUT name="Capone" type="button"
         value="Capone"
         onclick='show("container1");hide("container2")'>
  <INPUT name="Luciano" type="button"
         value="Luciano"
         onclick='show("container2");hide("container1")'>
</FORM>
</BODY>
</HTML>
```

12 Generated content, automatic numbering, and lists

Contents

12.1 The :before and :after pseudo-elements	203
12.2 The 'content' property	205
12.3 Quotation marks	207
12.3.1 Specifying quotes with the 'quotes' property	207
12.3.2 Inserting quotes with the 'content' property	209
12.4 Automatic counters and numbering	210
12.4.1 Nested counters and scope	212
12.4.2 Counter styles	214
12.4.3 Counters in elements with 'display: none'	214
12.5 Lists	214
12.5.1 Lists: the 'list-style-type', 'list-style-image', 'list-style-position', and 'list-style' properties	215

In some cases, authors may want user agents to render content that does not come from the document tree [p. 45] . One familiar example of this is a numbered list; the author does not want to list the numbers explicitly, he or she wants the user agent to generate them automatically. Similarly, authors may want the user agent to insert the word "Figure" before the caption of a figure, or "Chapter 7" before the seventh chapter title. For audio or braille in particular, user agents should be able to insert these strings.

In CSS 2.1, content may be generated by two mechanisms:

- The 'content' property, in conjunction with the :before and :after pseudo-elements.
- Elements with a value of 'list-item' for the 'display' property.

12.1 The :before and :after pseudo-elements

Authors specify the style and location of generated content with the :before and :after pseudo-elements. As their names indicate, the :before and :after pseudo-elements specify the location of content before and after an element's document tree [p. 45] content. The 'content' property, in conjunction with these pseudo-elements, specifies what is inserted.

Example(s):

For example, the following rule inserts the string "Note: " before the content of every P element whose "class" attribute has the value "note":

```
p.note:before { content: "Note: " }
```

The formatting objects (e.g., boxes) generated by an element include generated content. So, for example, changing the above style sheet to:

```
p.note:before { content: "Note: " }
p.note        { border: solid green }
```

would cause a solid green border to be rendered around the entire paragraph, including the initial string.

The `:before` and `:after` pseudo-elements inherit [p. 100] any inheritable properties from the element in the document tree to which they are attached.

Example(s):

For example, the following rules insert an open quote mark before every `Q` element. The color of the quote mark will be red, but the font will be the same as the font of the rest of the `Q` element:

```
q:before {
  content: open-quote;
  color: red;
}
```

In a `:before` or `:after` pseudo-element declaration, non-inherited properties take their initial values [p. 31] .

Example(s):

So, for example, because the initial value of the `'display'` property is `'inline'`, the quote in the previous example is inserted as an inline box (i.e., on the same line as the element's initial text content). The next example explicitly sets the `'display'` property to `'block'`, so that the inserted text becomes a block:

```
body:after {
  content: "The End";
  display: block;
  margin-top: 2em;
  text-align: center;
}
```

The `:before` and `:after` pseudo-elements interact with other boxes, such as run-in boxes, as if they were real elements inserted just inside their associated element.

Example(s):

For example, the following document fragment and style sheet:

```
<h2> Header </h2>                h2 { display: run-in; }
<p> Text </p>                    p:before { display: block; content: 'Some'; }
```

...would render in exactly the same way as the following document fragment and style sheet:

```
<h2> Header </h2>          h2 { display: run-in; }
<p><span>Some</span> Text </p> span { display: block }
```

Similarly, the following document fragment and style sheet:

```
<h2> Header </h2>          h2 { display: run-in; }
                             h2:after { display: block; content: 'Thing'; }
<p> Text </p>
```

...would render in exactly the same way as the following document fragment and style sheet:

```
<h2> Header <span>Thing</span></h2>  h2 { display: block; }
                                     span { display: block; }
<p> Text </p>
```

Note. This specification does not fully define the interaction of `:before` and `:after` with replaced elements (such as `IMG` in HTML). This will be defined in more detail in a future specification.

12.2 The 'content' property

'content'

<i>Value:</i>	normal none [<string> <uri> <counter> attr(<identifier> open-quote close-quote no-open-quote no-close-quote]+ inherit
<i>Initial:</i>	normal
<i>Applies to:</i>	:before and :after pseudo-elements
<i>Inherited:</i>	no
<i>Percentages:</i>	N/A
<i>Media:</i>	all
<i>Computed value:</i>	On elements, always computes to 'normal'. On <code>:before</code> and <code>:after</code> , if 'normal' is specified, computes to 'none'. Otherwise, for URI values, the absolute URI; for <code>attr()</code> values, the resulting string; for other keywords, as specified.

This property is used with the `:before` and `:after` pseudo-elements to generate content in a document. Values have the following meanings:

none

The pseudo-element is not generated.

normal

Computes to 'none' for the `:before` and `:after` pseudo-elements.

<string>

Text content (see the section on strings [p. 70]).

<uri>

The value is a URI that designates an external resource (such as an image). If the user agent cannot display the resource it must either leave it out as if it were

not specified or display some indication that the resource cannot be displayed.

<counter>

Counters [p. 68] may be specified with two different functions: 'counter()' or 'counters()'. The former has two forms: 'counter(*name*)' or 'counter(*name*, *style*)'. The generated text is the value of the innermost counter of the given name in scope at this pseudo-element; it is formatted in the indicated style [p. 214] ('decimal' by default). The latter function also has two forms: 'counters(*name*, *string*)' or 'counters(*name*, *string*, *style*)'. The generated text is the value of all counters with the given name in scope at this pseudo-element, from outermost to innermost separated by the specified string. The counters are rendered in the indicated style [p. 214] ('decimal' by default). See the section on automatic counters and numbering [p. 210] for more information. The name must not be 'none', 'inherit' or 'initial'. Such a name causes the declaration to be ignored.

open-quote and close-quote

These values are replaced by the appropriate string from the 'quotes' property.

no-open-quote and no-close-quote

Introduces no content, but increments (decrements) the level of nesting for quotes.

attr(X)

This function returns as a string the value of attribute X for the subject of the selector. The string is not parsed by the CSS processor. If the subject of the selector does not have an attribute X, an empty string is returned. The case-sensitivity of attribute names depends on the document language.

Note. In CSS 2.1, it is not possible to refer to attribute values for other elements than the subject of the selector.

The 'display' property controls whether the content is placed in a block or inline box.

Example(s):

The following rule causes the string "Chapter: " to be generated before each H1 element:

```
H1:before {
  content: "Chapter: ";
  display: inline;
}
```

Authors may include newlines in the generated content by writing the "\A" escape sequence in one of the strings after the 'content' property. This inserted line break is still subject to the 'white-space' property. See "Strings" [p. 70] and "Characters and case" [p. 55] for more information on the "\A" escape sequence.

Example(s):

```
h1:before {
  display: block;
  text-align: center;
  white-space: pre;
  content: "chapter\A hoofdstuk\A chapitre"
}
```

Generated content does not alter the document tree. In particular, it is not fed back to the document language processor (e.g., for reparsing).

12.3 Quotation marks

In CSS 2.1, authors may specify, in a style-sensitive and context-dependent manner, how user agents should render quotation marks. The 'quotes' property specifies pairs of quotation marks for each level of embedded quotation. The 'content' property gives access to those quotation marks and causes them to be inserted before and after a quotation.

12.3.1 Specifying quotes with the 'quotes' property

'quotes'

<i>Value:</i>	[<string> <string>]+ none inherit
<i>Initial:</i>	depends on user agent
<i>Applies to:</i>	all elements
<i>Inherited:</i>	yes
<i>Percentages:</i>	N/A
<i>Media:</i>	visual
<i>Computed value:</i>	as specified

This property specifies quotation marks for any number of embedded quotations. Values have the following meanings:

none

The 'open-quote' and 'close-quote' values of the 'content' property produce no quotation marks.

[<string> <string>]+

Values for the 'open-quote' and 'close-quote' values of the 'content' property are taken from this list of pairs of quotation marks (opening and closing). The first (leftmost) pair represents the outermost level of quotation, the second pair the first level of embedding, etc. The user agent must apply the appropriate pair of quotation marks according to the level of embedding.

Example(s):

For example, applying the following style sheet:

```

/* Specify pairs of quotes for two levels in two languages */
q:lang(en) { quotes: ' ' ' ' ' ' ' ' }
q:lang(no) { quotes: "«" "»" ' ' ' ' }

/* Insert quotes before and after Q element content */
q:before { content: open-quote }
q:after { content: close-quote }

```

to the following HTML fragment:

```

<HTML lang="en">
  <HEAD>
    <TITLE>Quotes</TITLE>
  </HEAD>
  <BODY>
    <P><Q>Quote me!</Q>
  </BODY>
</HTML>

```

would allow a user agent to produce:

"Quote me!"

while this HTML fragment:

```

<HTML lang="no">
  <HEAD>
    <TITLE>Quotes</TITLE>
  </HEAD>
  <BODY>
    <P><Q>Trøndere gråter når <Q>Vinsjan på kaia</Q> blir deklamert.</Q>
  </BODY>
</HTML>

```

would produce:

«Trøndere gråter når "Vinsjan på kaia" blir deklamert.»

Note. While the quotation marks specified by 'quotes' in the previous examples are conveniently located on computer keyboards, high quality typesetting would require different ISO 10646 characters. The following informative table lists some of the ISO 10646 quotation mark characters:

Character	Approximate rendering	ISO 10646 code (hex)	Description
"	"	0022	QUOTATION MARK [the ASCII double quotation mark]
'	'	0027	APOSTROPHE [the ASCII single quotation mark]
‹	<	2039	SINGLE LEFT-POINTING ANGLE QUOTATION MARK
›	>	203A	SINGLE RIGHT-POINTING ANGLE QUOTATION MARK
«	«	00AB	LEFT-POINTING DOUBLE ANGLE QUOTATION MARK
»	»	00BB	RIGHT-POINTING DOUBLE ANGLE QUOTATION MARK
‘	‘	2018	LEFT SINGLE QUOTATION MARK [single high-6]
’	’	2019	RIGHT SINGLE QUOTATION MARK [single high-9]
“	“	201C	LEFT DOUBLE QUOTATION MARK [double high-6]
”	”	201D	RIGHT DOUBLE QUOTATION MARK [double high-9]
„	„	201E	DOUBLE LOW-9 QUOTATION MARK [double low-9]

12.3.2 Inserting quotes with the 'content' property

Quotation marks are inserted in appropriate places in a document with the 'open-quote' and 'close-quote' values of the 'content' property. Each occurrence of 'open-quote' or 'close-quote' is replaced by one of the strings from the value of 'quotes', based on the depth of nesting.

'Open-quote' refers to the first of a pair of quotes, 'close-quote' refers to the second. Which pair of quotes is used depends on the nesting level of quotes: the number of occurrences of 'open-quote' in all generated text before the current occurrence, minus the number of occurrences of 'close-quote'. If the depth is 0, the first pair is used, if the depth is 1, the second pair is used, etc. If the depth is greater than the number of pairs, the last pair is repeated. A 'close-quote' or 'no-close-quote' that would make the depth negative is in error and is ignored (at rendering time): the

depth stays at 0 and no quote mark is rendered (although the rest of the 'content' property's value is still inserted).

Note. *The quoting depth is independent of the nesting of the source document or the formatting structure.*

Some typographic styles require open quotation marks to be repeated before every paragraph of a quote spanning several paragraphs, but only the last paragraph ends with a closing quotation mark. In CSS, this can be achieved by inserting "phantom" closing quotes. The keyword 'no-close-quote' decrements the quoting level, but does not insert a quotation mark.

Example(s):

The following style sheet puts opening quotation marks on every paragraph in a BLOCKQUOTE, and inserts a single closing quote at the end:

```
blockquote p:before      { content: open-quote }
blockquote p:after       { content: no-close-quote }
blockquote p.last:after  { content: close-quote }
```

This relies on the last paragraph being marked with a class "last".

For symmetry, there is also a 'no-open-quote' keyword, which inserts nothing, but increments the quotation depth by one.

12.4 Automatic counters and numbering

Automatic numbering in CSS 2.1 is controlled with two properties, 'counter-increment' and 'counter-reset'. The counters defined by these properties are used with the counter() and counters() functions of the the 'content' property.

'counter-reset'

<i>Value:</i>	[<identifier> <integer>?]+ none inherit
<i>Initial:</i>	none
<i>Applies to:</i>	all elements
<i>Inherited:</i>	no
<i>Percentages:</i>	N/A
<i>Media:</i>	all
<i>Computed value:</i>	as specified

'counter-increment'

<i>Value:</i>	[<identifier> <integer>?]+ none inherit
<i>Initial:</i>	none
<i>Applies to:</i>	all elements
<i>Inherited:</i>	no
<i>Percentages:</i>	N/A
<i>Media:</i>	all
<i>Computed value:</i>	as specified

The 'counter-increment' property accepts one or more names of counters (identifiers), each one optionally followed by an integer. The integer indicates by how much the counter is incremented for every occurrence of the element. The default increment is 1. Zero and negative integers are allowed.

The 'counter-reset' property also contains a list of one or more names of counters, each one optionally followed by an integer. The integer gives the value that the counter is set to on each occurrence of the element. The default is 0.

The keywords 'none', 'inherit' and 'initial' must not be used as counter names. A value of 'none' on its own means no counters are reset, resp. incremented. 'Inherit' on its own has its usual meaning (see 6.2.1 [p. 101]). 'Initial' is reserved for future use.

Example(s):

This example shows a way to number chapters and sections with "Chapter 1", "1.1", "1.2", etc.

```
BODY {
  counter-reset: chapter;      /* Create a chapter counter scope */
}
H1:before {
  content: "Chapter " counter(chapter) ". ";
  counter-increment: chapter; /* Add 1 to chapter */
}
H1 {
  counter-reset: section;     /* Set section to 0 */
}
H2:before {
  content: counter(chapter) "." counter(section) " ";
  counter-increment: section;
}
```

If an element increments/resets a counter and also uses it (in the 'content' property of its :before or :after pseudo-element), the counter is used *after* being incremented/reset.

If an element both resets and increments a counter, the counter is reset first and then incremented.

If the same counter is specified more than once in the value of the 'counter-reset' and 'counter-increment' properties, each reset/increment of the counter is processed in the order specified.

Example(s):

The following example will reset the 'section' counter to 0:

```
H1 { counter-reset: section 2 section }
```

The following example will increment the 'chapter' counter by 3:

```
H1 { counter-increment: chapter chapter 2 }
```

The 'counter-reset' property follows the cascading rules. Thus, due to cascading, the following style sheet:

```
H1 { counter-reset: section -1 }
H1 { counter-reset: imagenum 99 }
```

will only reset 'imagenum'. To reset both counters, they have to be specified together:

```
H1 { counter-reset: section -1 imagenum 99 }
```

12.4.1 Nested counters and scope

Counters are "self-nesting", in the sense that resetting a counter in a descendant element or pseudo-element automatically creates a new instance of the counter. This is important for situations like lists in HTML, where elements can be nested inside themselves to arbitrary depth. It would be impossible to define uniquely named counters for each level.

Example(s):

Thus, the following suffices to number nested list items. The result is very similar to that of setting 'display:list-item' and 'list-style: inside' on the LI element:

```
OL { counter-reset: item }
LI { display: block }
LI:before { content: counter(item) ". "; counter-increment: item }
```

The *scope* of a counter starts at the first element in the document that has a 'counter-reset' for that counter and includes the element's descendants and its following siblings with their descendants. However, it does not include any elements in the scope of a counter with the same name created by a 'counter-reset' on a later sibling of the element or by a later 'counter-reset' on the same element.

If 'counter-increment' or 'content' on an element or pseudo-element refers to a counter that is not in the scope of any 'counter-reset', implementations should behave as though a 'counter-reset' had reset the counter to 0 on that element or pseudo-element.

In the example above, an OL will create a counter, and all children of the OL will refer to that counter.

If we denote by `item[n]` the n^{th} instance of the "item" counter, and by "{" and "}" the beginning and end of a scope, then the following HTML fragment will use the indicated counters. (We assume the style sheet as given in the example above).

```

<OL>                                <!-- {item[0]=0      -->
  <LI>item</LI>                       <!-- item[0]++ (=1)  -->
  <LI>item                             <!-- item[0]++ (=2)  -->
    <OL>                                <!-- {item[1]=0      -->
      <LI>item</LI>                     <!-- item[1]++ (=1)  -->
      <LI>item</LI>                     <!-- item[1]++ (=2)  -->
      <LI>item                           <!-- item[1]++ (=3)  -->
        <OL>                            <!-- {item[2]=0      -->
          <LI>item</LI>                 <!-- item[2]++ (=1)  -->
        </OL>                          <!-- }                -->
      <OL>                              <!-- {item[2]=0      -->
        <LI>item</LI>                 <!-- item[2]++ (=1)  -->
      </OL>                              <!-- }                -->
    </LI>                               <!-- }                -->
  <LI>item</LI>                       <!-- item[1]++ (=4)  -->
</OL>                                <!-- }                -->
</LI>                                 <!-- }                -->
<LI>item</LI>                       <!-- item[0]++ (=3)  -->
<LI>item</LI>                       <!-- item[0]++ (=4)  -->
</OL>                                <!-- }                -->
<OL>                                <!-- {item[0]=0      -->
  <LI>item</LI>                       <!-- item[0]++ (=1)  -->
  <LI>item</LI>                       <!-- item[0]++ (=2)  -->
</OL>                                <!-- }                -->

```

Example(s):

Another example, showing how scope works when counters are used on elements that are not nested, is the following. This shows how the style rules given above to number chapters and sections would apply to the markup given.

```

                                <!--"chapter" counter|"section" counter -->
<body>                          <!-- {chapter=0      |          -->
  <h1>About CSS</h1>           <!-- chapter++ (=1) | {section=0      -->
  <h2>CSS 2</h2>               <!-- |          | section++ (=1)  -->
  <h2>CSS 2.1</h2>            <!-- |          | section++ (=2)  -->
  <h1>Style</h1>              <!-- chapter++ (=2) |}{ section=0  -->
</body>                        <!-- |          | }          -->

```

The `'counters()'` function generates a string composed of all of the counters with the same name that are in scope, separated by a given string.

Example(s):

The following style sheet numbers nested list items as "1", "1.1", "1.1.1", etc.

```

OL { counter-reset: item }
LI { display: block }
LI:before { content: counters(item, ".") " "; counter-increment: item }

```

12.4.2 Counter styles

By default, counters are formatted with decimal numbers, but all the styles available for the 'list-style-type' property are also available for counters. The notation is:

```
counter(name)
```

for the default style, or:

```
counter(name, <'list-style-type'>)
```

All the styles are allowed, including 'disc', 'circle', 'square', and 'none'.

Example(s):

```
H1:before      { content: counter(chno, upper-latin) ". " }
H2:before      { content: counter(section, upper-roman) " - " }
BLOCKQUOTE:after { content: " [" counter(bq, lower-greek) "]" }
DIV.note:before { content: counter(notecntr, disc) " " }
P:before       { content: counter(p, none) }
```

12.4.3 Counters in elements with 'display: none'

An element that is not displayed ('display' set to 'none') cannot increment or reset a counter.

Example(s):

For example, with the following style sheet, H2s with class "secret" do not increment 'count2'.

```
H2.secret {counter-increment: count2; display: none}
```

Pseudo-elements that are not generated also cannot increment or reset a counter.

Example(s):

For example, the following does not increment 'heading':

```
h1::before {
  content: normal;
  counter-increment: heading;
}
```

Elements with 'visibility' set to 'hidden', on the other hand, *do* increment counters.

12.5 Lists

CSS 2.1 offers basic visual formatting of lists. An element with 'display: list-item' generates a principal box [p. 129] for the element's content and, depending on the values of 'list-style-type' and 'list-style-image', possibly also a marker box as a visual indication that the element is a list item.

The *list properties* describe basic visual formatting of lists: they allow style sheets to specify the marker type (image, glyph, or number), and the marker position with respect to the principal box (outside it or within it before content). They do not allow authors to specify distinct style (colors, fonts, alignment, etc.) for the list marker or adjust its position with respect to the principal box; these may be derived from the principal box.

The background properties [p. 232] apply to the principal box only; an 'outside' marker box is transparent.

12.5.1 Lists: the 'list-style-type', 'list-style-image', 'list-style-position', and 'list-style' properties

'list-style-type'

<i>Value:</i>	disc circle square decimal decimal-leading-zero lower-roman upper-roman lower-greek lower-latin upper-latin armenian georgian lower-alpha upper-alpha none inherit
<i>Initial:</i>	disc
<i>Applies to:</i>	elements with 'display: list-item'
<i>Inherited:</i>	yes
<i>Percentages:</i>	N/A
<i>Media:</i>	visual
<i>Computed value:</i>	as specified

This property specifies appearance of the list item marker if 'list-style-image' has the value 'none' or if the image pointed to by the URI cannot be displayed. The value 'none' specifies no marker, otherwise there are three types of marker: glyphs, numbering systems, and alphabetic systems.

Glyphs are specified with **disc**, **circle**, and **square**. Their exact rendering depends on the user agent.

Numbering systems are specified with:

decimal

Decimal numbers, beginning with 1.

decimal-leading-zero

Decimal numbers padded by initial zeros (e.g., 01, 02, 03, ..., 98, 99).

lower-roman

Lowercase roman numerals (i, ii, iii, iv, v, etc.).

upper-roman

Uppercase roman numerals (I, II, III, IV, V, etc.).

georgian

Traditional Georgian numbering (an, ban, gan, ..., he, tan, in, in-an, ...).

armenian

Traditional uppercase Armenian numbering.

Alphabetic systems are specified with:

lower-latin or lower-alpha

Lowercase ascii letters (a, b, c, ... z).

upper-latin or upper-alpha

Uppercase ascii letters (A, B, C, ... Z).

lower-greek

Lowercase classical Greek alpha, beta, gamma, ... (α, β, γ, ...)

This specification does not define how alphabetic systems wrap at the end of the alphabet. For instance, after 26 list items, 'lower-latin' rendering is undefined. Therefore, for long lists, we recommend that authors specify true numbers.

For example, the following HTML document:

```
<!DOCTYPE HTML PUBLIC "-//W3C//DTD HTML 4.01//EN">
<HTML>
  <HEAD>
    <TITLE>Lowercase latin numbering</TITLE>
    <STYLE type="text/css">
      ol { list-style-type: lower-roman }
    </STYLE>
  </HEAD>
  <BODY>
    <OL>
      <LI> This is the first item.
      <LI> This is the second item.
      <LI> This is the third item.
    </OL>
  </BODY>
</HTML>
```

might produce something like this:

```
  i This is the first item.
 ii This is the second item.
 iii This is the third item.
```

The list marker alignment (here, right justified) depends on the user agent.

'list-style-image'

<i>Value:</i>	<uri> none inherit
<i>Initial:</i>	none
<i>Applies to:</i>	elements with 'display: list-item'
<i>Inherited:</i>	yes
<i>Percentages:</i>	N/A
<i>Media:</i>	visual
<i>Computed value:</i>	absolute URI or 'none'

This property sets the image that will be used as the list item marker. When the image is available, it will replace the marker set with the 'list-style-type' marker.

The size of the image is calculated from the following rules:

1. If the image has an intrinsic width or height, then that intrinsic width/height becomes the image's used width/height.
2. If the image's intrinsic width or height is given as a percentage, then that percentage is resolved against 1em.
3. If the image has no intrinsic ratio and a ratio cannot be calculated from its width and height, then its intrinsic ratio is assumed to be 1:1.
4. If the image has a width but no height, its height is calculated from the intrinsic ratio.
5. If the image's height cannot be resolved from the rules above, then the image's height is assumed to be 1em.
6. If the image has no intrinsic width, then its width is calculated from the resolved height and the intrinsic ratio.

Example(s):

The following example sets the marker at the beginning of each list item to be the image "ellipse.png".

```
ul { list-style-image: url("http://png.com/ellipse.png") }
```

'list-style-position'

<i>Value:</i>	inside outside inherit
<i>Initial:</i>	outside
<i>Applies to:</i>	elements with 'display: list-item'
<i>Inherited:</i>	yes
<i>Percentages:</i>	N/A
<i>Media:</i>	visual
<i>Computed value:</i>	as specified

This property specifies the position of the marker box with respect to the principal block box. Values have the following meanings:

outside

The marker box is outside the principal block box. The position of the list-item marker adjacent to floats is undefined in CSS 2.1 CSS 2.1 does not specify the precise location of the marker box or its position in the painting order, but does require that for list items whose 'direction' property is 'ltr' the marker box be on the left side of the content and for elements whose 'direction' property is 'rtl' the marker box be on the right side of the content. The marker box is fixed with respect to the principal block box's border and does not scroll with the principal block box's content. In CSS 2.1, a UA may hide the marker if the element's 'overflow' is other than 'visible'. (This is expected to change in the future.) The

size or contents of the marker box may affect the height of the principal block box and/or the height of its first line box, and in some cases may cause the creation of a new line box. **Note:** This interaction may be more precisely defined in a future level of CSS.

inside

The marker box is placed as the first inline box in the principal block box, before the element's content and before any `:before` pseudo-elements. CSS 2.1 does not specify the precise location of the marker box.

For example:

```
<HTML>
  <HEAD>
    <TITLE>Comparison of inside/outside position</TITLE>
    <STYLE type="text/css">
      ul { list-style: outside }
      ul.compact { list-style: inside }
    </STYLE>
  </HEAD>
  <BODY>
    <UL>
      <LI>first list item comes first
      <LI>second list item comes second
    </UL>

    <UL class="compact">
      <LI>first list item comes first
      <LI>second list item comes second
    </UL>
  </BODY>
</HTML>
```

The above example may be formatted as:

- first list item
comes first
- second list item
comes second

-
- first list
item comes first
 - second list
item comes second

↑
*The left sides of the
list item boxes are not
affected by marker placement*

In right-to-left text, the markers would have been on the right side of the box.

'list-style'

<i>Value:</i>	[<'list-style-type'> <'list-style-position'> <'list-style-image'>] inherit
<i>Initial:</i>	see individual properties
<i>Applies to:</i>	elements with 'display: list-item'
<i>Inherited:</i>	yes
<i>Percentages:</i>	N/A
<i>Media:</i>	visual
<i>Computed value:</i>	see individual properties

The 'list-style' property is a shorthand notation for setting the three properties 'list-style-type', 'list-style-image', and 'list-style-position' at the same place in the style sheet.

Example(s):

```
ul { list-style: upper-roman inside } /* Any "ul" element */
ul > li > ul { list-style: circle outside } /* Any "ul" child
                                             of an "li" child
                                             of a "ul" element */
```

Although authors may specify 'list-style' information directly on list item elements (e.g., "li" in HTML), they should do so with care. The following rules look similar, but the first declares a descendant selector [p. 80] and the second a (more specific) child selector. [p. 81]

```
ol.alpha li { list-style: lower-alpha } /* Any "li" descendant of an "ol" */
ol.alpha > li { list-style: lower-alpha } /* Any "li" child of an "ol" */
```

Authors who use only the descendant selector [p. 80] may not achieve the results they expect. Consider the following rules:

```
<HTML>
<HEAD>
  <TITLE>WARNING: Unexpected results due to cascade</TITLE>
  <STYLE type="text/css">
    ol.alpha li { list-style: lower-alpha }
    ul li      { list-style: disc }
  </STYLE>
</HEAD>
<BODY>
  <OL class="alpha">
    <LI>level 1
    <UL>
      <LI>level 2
    </UL>
  </OL>
</BODY>
</HTML>
```

The desired rendering would have level 1 list items with 'lower-alpha' labels and level 2 items with 'disc' labels. However, the cascading order [p. 103] will cause the first style rule (which includes specific class information) to mask the second. The following rules solve the problem by employing a child selector [p. 81] instead:

```
ol.alpha > li { list-style: lower-alpha }
ul li { list-style: disc }
```

Another solution would be to specify 'list-style' information only on the list type elements:

```
ol.alpha { list-style: lower-alpha }
ul { list-style: disc }
```

Inheritance will transfer the 'list-style' values from OL and UL elements to LI elements. This is the recommended way to specify list style information.

Example(s):

A URI value may be combined with any other value, as in:

```
ul { list-style: url("http://png.com/ellipse.png") disc }
```

In the example above, the 'disc' will be used when the image is unavailable.

A value of 'none' within the 'list-style' property sets whichever of 'list-style-type' and 'list-style-image' are not otherwise specified to 'none'. However, if both are otherwise specified, the declaration is in error (and thus ignored).

Example(s):

For example, a value of 'none' for the 'list-style' property sets both 'list-style-type' and 'list-style-image' to 'none':

```
ul { list-style: none }
```

The result is that no list-item marker is displayed.

13 Paged media

Contents

13.1 Introduction to paged media	221
13.2 Page boxes: the @page rule	222
13.2.1 Page margins	222
13.2.2 Page selectors: selecting left, right, and first pages	224
13.2.3 Content outside the page box	225
13.3 Page breaks	225
13.3.1 Page break properties: 'page-break-before', 'page-break-after', 'page-break-inside'	225
13.3.2 Breaks inside elements: 'orphans', 'widows'	227
13.3.3 Allowed page breaks	227
13.3.4 Forced page breaks	228
13.3.5 "Best" page breaks	228
13.4 Cascading in the page context	229

13.1 Introduction to paged media

Paged media (e.g., paper, transparencies, pages that are displayed on computer screens, etc.) differ from continuous media [p. 110] in that the content of the document is split into one or more discrete pages. To handle pages, CSS 2.1 describes how page margins are set on page boxes [p. 222], and how page breaks [p. 225] are declared.

The user agent is responsible for transferring the page boxes of a document onto the real *sheets* where the document will ultimately be rendered (paper, transparency, screen, etc.). There is often a 1-to-1 relationship between a page box and a sheet, but this is not always the case. Transfer possibilities include:

- Transferring one page box to one sheet (e.g., single-sided printing).
- Transferring two page boxes to both sides of the same sheet (e.g., double-sided printing).
- Transferring N (small) page boxes to one sheet (called "n-up").
- Transferring one (large) page box to N x M sheets (called "tiling").
- Creating signatures. A signature is a group of pages printed on a sheet, which, when folded and trimmed like a book, appear in their proper sequence.
- Printing one document to several output trays.
- Outputting to a file.

13.2 Page boxes: the @page rule

The *page box* is a rectangular region that contains two areas:

- The *page area*. The page area includes the boxes laid out on that page. The edges of the first page area establish the rectangle that is the initial containing block [p. 171] of the document. The canvas background is painted within and covers the page area.
- The margin area, which surrounds the page area. The page margin area is transparent.

The size of a page box cannot be specified in CSS 2.1.

Authors can specify the margins of a page box inside an @page rule. An @page rule consists of the keyword "@page", followed by an optional page selector, followed by a block containing declarations and at-rules. The declarations in an @page rule are said to be in the *page context*.

Note: CSS level 2 has no at-rules that may appear inside @page, but such at-rules are expected to be defined in level 3.

The *page selector* specifies for which pages the declarations apply. In CSS 2.1, page selectors may designate the first page, all left pages, or all right pages

The rules for handling malformed declarations, malformed statements, and invalid at-rules inside @page are as defined in section 4.2, [p. 60] with the following addition: when the UA expects the start of a declaration or at-rule (i.e., an IDENT token or an ATKEYWORD token) but finds an unexpected token instead, that token is considered to be the first token of a malformed declaration. I.e., the rule for malformed declarations, rather than malformed statements is used to determine which tokens to ignore in that case.

13.2.1 Page margins

In CSS 2.1, only the margin properties [p. 115] ('margin-top', 'margin-right', 'margin-bottom', 'margin-left', and 'margin') apply within the page context [p. 222]. The following diagram shows the relationships between the sheet, page box, and page margins:

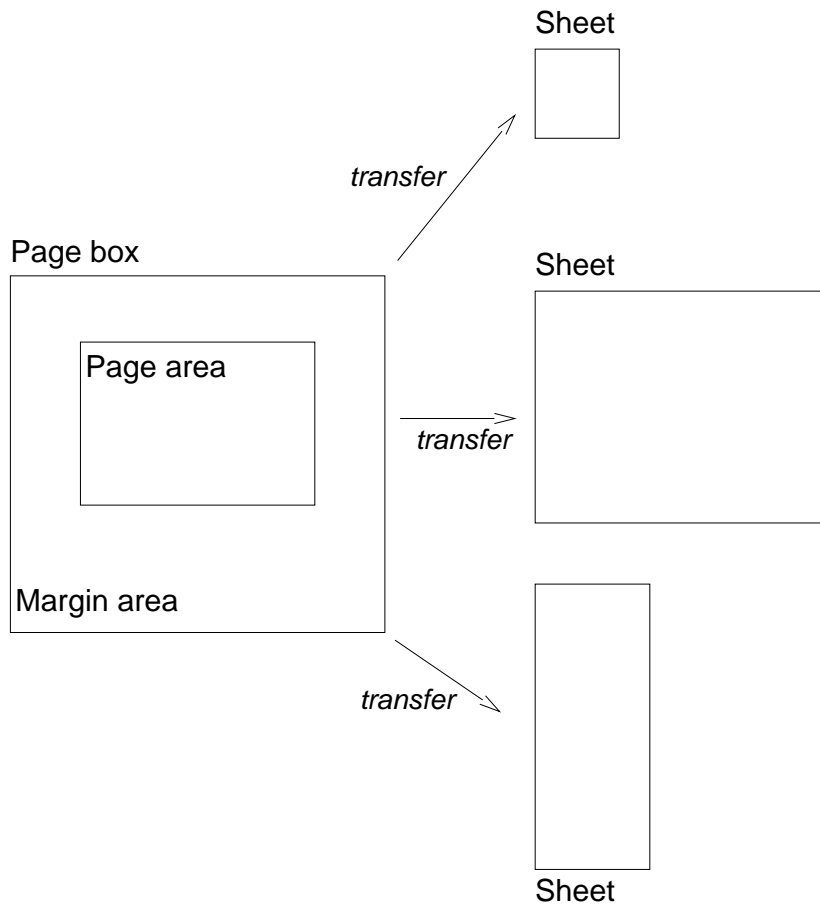

Example(s):

Here is a simple example which sets all page margins on all pages:

```
@page {
  margin: 3cm;
}
```

The page context [p. 222] has no notion of fonts, so 'em' and 'ex' units are not allowed. Percentage values on the margin properties are relative to the dimensions of the page box [p. 222] ; for left and right margins, they refer to the width of the page box while for top and bottom margins, they refer to the height of the page box. All other units associated with the respective CSS 2.1 properties are allowed.

Due to negative margin values (either on the page box or on elements) or absolute positioning [p. 152] content may end up outside the page box, but this content may be "cut" — by the user agent, the printer, or ultimately, the paper cutter.

13.2.2 Page selectors: selecting left, right, and first pages

When printing double-sided documents, the page boxes [p. 222] on left and right pages may be different. This can be expressed through two CSS pseudo-classes that may be used in page selectors.

All pages are automatically classified by user agents into either the `:left` or `:right` pseudo-class. Whether the first page of a document is `:left` or `:right` depends on the major writing direction of the root element. For example, the first page of a document with a left-to-right major writing direction would be a `:right` page, and the first page of a document with a right-to-left major writing direction would be a `:left` page. To explicitly force a document to begin printing on a left or right page, authors can insert a page break [p. 225] before the first generated box.

Example(s):

```
@page :left {
  margin-left: 4cm;
  margin-right: 3cm;
}

@page :right {
  margin-left: 3cm;
  margin-right: 4cm;
}
```

If different declarations have been given for left and right pages, the user agent must honor these declarations even if the user agent does not transfer the page boxes to left and right sheets (e.g., a printer that only prints single-sided).

Authors may also specify style for the first page of a document with the `:first` pseudo-class:

Example(s):

```
@page { margin: 2cm } /* All margins set to 2cm */

@page :first {
  margin-top: 10cm /* Top margin on first page 10cm */
}
```

Properties specified in a `:left` or `:right` `@page` rule override those specified in an `@page` rule that has no pseudo-class specified. Properties specified in a `:first` `@page` rule override those specified in `:left` or `:right` `@page` rules.

Margin declarations on left, right, and first pages may result in different page area [p. 222] widths. To simplify implementations, user agents may use a single page area width on left, right, and first pages. In this case, the page area width of the first page should be used.

13.2.3 Content outside the page box

When formatting content in the page model, some content may end up outside the current page box. For example, an element whose 'white-space' property has the value 'pre' may generate a box that is wider than the page box. As another example, when boxes are positioned absolutely or relatively, they may end up in "inconvenient" locations. For example, images may be placed on the edge of the page box or 100,000 meters below the page box.

The exact formatting of such elements lies outside the scope of this specification. However, we recommend that authors and user agents observe the following general principles concerning content outside the page box:

- Content should be allowed slightly beyond the page box to allow pages to "bleed".
- User agents should avoid generating a large number of empty page boxes to honor the positioning of elements (e.g., you do not want to print 100 blank pages).
- Authors should not position elements in inconvenient locations just to avoid rendering them.
- User agents may handle boxes positioned outside the page box in several ways, including discarding them or creating page boxes for them at the end of the document.

13.3 Page breaks

This section describes page breaks in CSS 2.1. Five properties indicate where the user agent may or should break pages, and on what page (left or right) the subsequent content should resume. Each page break ends layout in the current page box [p. 222] and causes remaining pieces of the document tree [p. 45] to be laid out in a new page box.

13.3.1 Page break properties: 'page-break-before', 'page-break-after', 'page-break-inside'

'page-break-before'

<i>Value:</i>	auto always avoid left right inherit
<i>Initial:</i>	auto
<i>Applies to:</i>	block-level elements (but see text)
<i>Inherited:</i>	no
<i>Percentages:</i>	N/A
<i>Media:</i>	visual, paged
<i>Computed value:</i>	as specified

'page-break-after'

<i>Value:</i>	auto always avoid left right inherit
<i>Initial:</i>	auto
<i>Applies to:</i>	block-level elements (but see text)
<i>Inherited:</i>	no
<i>Percentages:</i>	N/A
<i>Media:</i>	visual, paged
<i>Computed value:</i>	as specified

'page-break-inside'

<i>Value:</i>	avoid auto inherit
<i>Initial:</i>	auto
<i>Applies to:</i>	block-level elements (but see text)
<i>Inherited:</i>	no
<i>Percentages:</i>	N/A
<i>Media:</i>	visual, paged
<i>Computed value:</i>	as specified

Values for these properties have the following meanings:

auto

Neither force nor forbid a page break before (after, inside) the generated box.

always

Always force a page break before (after) the generated box.

avoid

Avoid a page break before (after, inside) the generated box.

left

Force one or two page breaks before (after) the generated box so that the next page is formatted as a left page.

right

Force one or two page breaks before (after) the generated box so that the next page is formatted as a right page.

A conforming user agent may interpret the values 'left' and 'right' as 'always'.

A potential page break location is typically under the influence of the parent element's 'page-break-inside' property, the 'page-break-after' property of the preceding element, and the 'page-break-before' property of the following element. When these properties have values other than 'auto', the values 'always', 'left', and 'right' take precedence over 'avoid'.

User Agents must apply these properties to block-level elements in the normal flow of the root element. User agents may also apply these properties to other elements, e.g., 'table-row' elements.

When a page break splits a box, the box's margins, borders, and padding have no visual effect where the split occurs.

13.3.2 Breaks inside elements: 'orphans', 'widows'

'orphans'

<i>Value:</i>	<integer> inherit
<i>Initial:</i>	2
<i>Applies to:</i>	block container elements
<i>Inherited:</i>	yes
<i>Percentages:</i>	N/A
<i>Media:</i>	visual, paged
<i>Computed value:</i>	as specified

'widows'

<i>Value:</i>	<integer> inherit
<i>Initial:</i>	2
<i>Applies to:</i>	block container elements
<i>Inherited:</i>	yes
<i>Percentages:</i>	N/A
<i>Media:</i>	visual, paged
<i>Computed value:</i>	as specified

The 'orphans' property specifies the minimum number of lines in a block container that must be left at the bottom of a page. The 'widows' property specifies the minimum number of lines in a block container that must be left at the top of a page. Examples of how they are used to control page breaks are given below.

Only positive values are allowed.

For information about paragraph formatting, please consult the section on line boxes [p. 139] .

13.3.3 Allowed page breaks

In the normal flow, page breaks can occur at the following places:

1. In the vertical margin between block boxes. When an unforced page break occurs here, the used values [p. 100] of the relevant 'margin-top' and 'margin-bottom' properties are set to '0'. When a forced page break occurs here, the used value of the relevant 'margin-bottom' property is set to '0'; the relevant 'margin-top' used value may either be set to '0' or retained.
2. Between line boxes [p. 139] inside a block [p. ??] box.
3. Between the content edge of a block box and the outer edges of its child content (margin edges of block-level children or line box edges for inline-level children) if

there is a (non-zero) gap between them.

Note: It is expected that CSS3 will specify that the relevant 'margin-top' applies (i.e., is not set to '0') after a forced page break.

These breaks are subject to the following rules:

- **Rule A:** Breaking at (1) is allowed only if the 'page-break-after' and 'page-break-before' properties of all the elements generating boxes that meet at this margin allow it, which is when at least one of them has the value 'always', 'left', or 'right', or when all of them are 'auto'.
- **Rule B:** However, if all of them are 'auto' and a common ancestor of all the elements has a 'page-break-inside' value of 'avoid', then breaking here is not allowed.
- **Rule C:** Breaking at (2) is allowed only if the number of line boxes [p. 139] between the break and the start of the enclosing block box is the value of 'orphans' or more, and the number of line boxes between the break and the end of the box is the value of 'widows' or more.
- **Rule D:** In addition, breaking at (2) or (3) is allowed only if the 'page-break-inside' property of the element and all its ancestors is 'auto'.

If the above does not provide enough break points to keep content from overflowing the page boxes, then rules A, B and D are dropped in order to find additional breakpoints.

If that still does not lead to sufficient break points, rule C is dropped as well, to find still more break points.

13.3.4 Forced page breaks

A page break *must* occur at (1) if, among the 'page-break-after' and 'page-break-before' properties of all the elements generating boxes that meet at this margin, there is at least one with the value 'always', 'left', or 'right'.

13.3.5 "Best" page breaks

CSS 2.1 does *not* define which of a set of allowed page breaks must be used; CSS 2.1 does not forbid a user agent from breaking at every possible break point, or not to break at all. But CSS 2.1 does recommend that user agents observe the following heuristics (while recognizing that they are sometimes contradictory):

- Break as few times as possible.
- Make all pages that do not end with a forced break appear to have about the same height.
- Avoid breaking inside a replaced element.

Example(s):

Suppose, for example, that the style sheet contains 'orphans: 4', 'widows: 2', and there are 20 lines (line boxes [p. 139]) available at the bottom of the current page:

- If a paragraph at the end of the current page contains 20 lines or fewer, it should be placed on the current page.
- If the paragraph contains 21 or 22 lines, the second part of the paragraph must not violate the 'widows' constraint, and so the second part must contain exactly two lines
- If the paragraph contains 23 lines or more, the first part should contain 20 lines and the second part the remaining lines.

Now suppose that 'orphans' is '10', 'widows' is '20', and there are 8 lines available at the bottom of the current page:

- If a paragraph at the end of the current page contains 8 lines or fewer, it should be placed on the current page.
- If the paragraph contains 9 lines or more, it cannot be split (that would violate the orphan constraint), so it should move as a block to the next page.

13.4 Cascading in the page context

Declarations in the page context [p. 222] obey the cascade [p. 99] just like normal CSS declarations.

Example(s):

Consider the following example:

```
@page {  
  margin-left: 3cm;  
}  
  
@page :left {  
  margin-left: 4cm;  
}
```

Due to the higher specificity [p. 103] of the pseudo-class selector, the left margin on left pages will be '4cm' and all other pages (i.e., the right pages) will have a left margin of '3cm'.

14 Colors and Backgrounds

Contents

14.1 Foreground color: the 'color' property	231
14.2 The background	231
14.2.1 Background properties: 'background-color', 'background-image', 'background-repeat', 'background-attachment', 'background-position', and 'background'	232
14.3 Gamma correction	238

CSS properties allow authors to specify the foreground color and background of an element. Backgrounds may be colors or images. Background properties allow authors to position a background image, repeat it, and declare whether it should be fixed with respect to the viewport [p. 128] or scrolled along with the document.

See the section on color units [p. 68] for the syntax of valid color values.

14.1 Foreground color: the 'color' property

'color'

<i>Value:</i>	<color> inherit
<i>Initial:</i>	depends on user agent
<i>Applies to:</i>	all elements
<i>Inherited:</i>	yes
<i>Percentages:</i>	N/A
<i>Media:</i>	visual
<i>Computed value:</i>	as specified

This property describes the foreground color of an element's text content. There are different ways to specify red:

Example(s):

```
em { color: red }           /* predefined color name */
em { color: rgb(255,0,0) } /* RGB range 0-255 */
```

14.2 The background

Authors may specify the background of an element (i.e., its rendering surface) as either a color or an image. In terms of the box model [p. 111], "background" refers to the background of the content [p. 111], padding [p. 111] and border [p. 111] areas. Border colors and styles are set with the border properties [p. 120]. Margins are always transparent.

Background properties are not inherited, but the parent box's background will shine through by default because of the initial 'transparent' value on 'background-color'.

The background of the root element becomes the background of the canvas and covers the entire canvas [p. 40] , anchored (for 'background-position') at the same point as it would be if it was painted only for the root element itself. The root element does not paint this background again.

For HTML documents, however, we recommend that authors specify the background for the BODY element rather than the HTML element. For documents whose root element is an HTML "HTML" element or an XHTML "html" element that has computed values of 'transparent' for 'background-color' and 'none' for 'background-image', user agents must instead use the computed value of the background properties from that element's first HTML "BODY" element or XHTML "body" element child when painting backgrounds for the canvas, and must not paint a background for that child element. Such backgrounds must also be anchored at the same point as they would be if they were painted only for the root element.

According to these rules, the canvas underlying the following HTML document will have a "marble" background:

```
<!DOCTYPE HTML PUBLIC "-//W3C//DTD HTML 4.01//EN">
  <TITLE>Setting the canvas background</TITLE>
  <STYLE type="text/css">
    BODY { background: url("http://example.com/marble.png") }
  </STYLE>
  <P>My background is marble.
```

Note that the rule for the BODY element will work even though the BODY tag has been omitted in the HTML source since the HTML parser will infer the missing tag.

Backgrounds of elements that form a stacking context (see the 'z-index' property) are painted at the bottom of the element's stacking context, below anything in that stacking context.

14.2.1 Background properties: 'background-color', 'background-image', 'background-repeat', 'background-attachment', 'background-position', and 'background'

'background-color'

<i>Value:</i>	<color> transparent inherit
<i>Initial:</i>	transparent
<i>Applies to:</i>	all elements
<i>Inherited:</i>	no
<i>Percentages:</i>	N/A
<i>Media:</i>	visual
<i>Computed value:</i>	as specified

This property sets the background color of an element, either a <color> value or the keyword 'transparent', to make the underlying colors shine through.

Example(s):

```
h1 { background-color: #F00 }
```

'background-image'

<i>Value:</i>	<uri> none inherit
<i>Initial:</i>	none
<i>Applies to:</i>	all elements
<i>Inherited:</i>	no
<i>Percentages:</i>	N/A
<i>Media:</i>	visual
<i>Computed value:</i>	absolute URI or none

This property sets the background image of an element. When setting a background image, authors should also specify a background color that will be used when the image is unavailable. When the image is available, it is rendered on top of the background color. (Thus, the color is visible in the transparent parts of the image).

Values for this property are either <uri>, to specify the image, or 'none', when no image is used.

Example(s):

```
body { background-image: url("marble.png") }
p { background-image: none }
```

Intrinsic dimensions expressed as percentages must be resolved relative to the dimensions of the rectangle that establishes the coordinate system for the 'background-position' property.

If the image has one of either an intrinsic width or an intrinsic height and an intrinsic aspect ratio, then the missing dimension is calculated from the given dimension and the ratio.

If the image has one of either an intrinsic width or an intrinsic height and no intrinsic aspect ratio, then the missing dimension is assumed to be the size of the rectangle that establishes the coordinate system for the 'background-position' property.

If the image has no intrinsic dimensions and has an intrinsic ratio the dimensions must be assumed to be the largest dimensions at that ratio such that neither dimension exceeds the dimensions of the rectangle that establishes the coordinate system for the 'background-position' property.

If the image has no intrinsic ratio either, then the dimensions must be assumed to be the rectangle that establishes the coordinate system for the 'background-position' property.

'background-repeat'

<i>Value:</i>	repeat repeat-x repeat-y no-repeat inherit
<i>Initial:</i>	repeat
<i>Applies to:</i>	all elements
<i>Inherited:</i>	no
<i>Percentages:</i>	N/A
<i>Media:</i>	visual
<i>Computed value:</i>	as specified

If a background image is specified, this property specifies whether the image is repeated (tiled), and how. All tiling covers the content [p. 111] , padding [p. 111] and border [p. 111] areas of a box.

The tiling and positioning of the background-image on inline elements is undefined in this specification. A future level of CSS may define the tiling and positioning of the background-image on inline elements.

Values have the following meanings:

repeat

The image is repeated both horizontally and vertically.

repeat-x

The image is repeated horizontally only.

repeat-y

The image is repeated vertically only.

no-repeat

The image is not repeated: only one copy of the image is drawn.

Example(s):

```
body {
  background: white url("pendant.png");
  background-repeat: repeat-y;
  background-position: center;
}
```

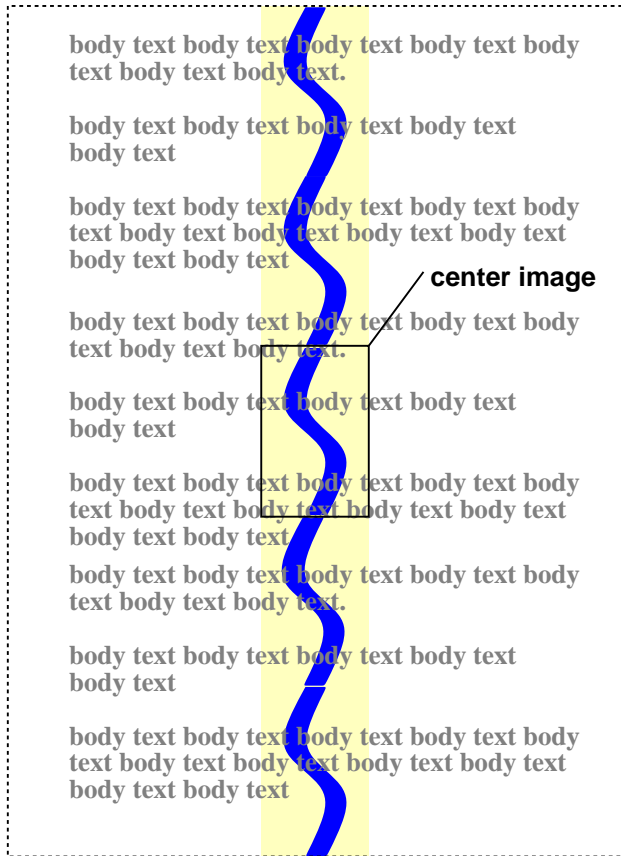

One copy of the background image is centered, and other copies are put above and below it to make a vertical band behind the element.

'background-attachment'

<i>Value:</i>	scroll fixed inherit
<i>Initial:</i>	scroll
<i>Applies to:</i>	all elements
<i>Inherited:</i>	no
<i>Percentages:</i>	N/A
<i>Media:</i>	visual
<i>Computed value:</i>	as specified

If a background image is specified, this property specifies whether it is fixed with regard to the viewport [p. 128] ('fixed') or scrolls along with the containing block ('scroll').

Note that there is only one viewport per view. If an element has a scrolling mechanism (see 'overflow'), a 'fixed' background does not move with the element, and a 'scroll' background does not move with the scrolling mechanism.

Even if the image is fixed, it is still only visible when it is in the content, padding or border area of the element. Thus, unless the image is tiled ('background-repeat: repeat'), it may be invisible.

Example(s):

This example creates an infinite vertical band that remains "glued" to the viewport when the element is scrolled.

```
body {
  background: red url("pendant.png");
  background-repeat: repeat-y;
  background-attachment: fixed;
}
```

User agents that do not support 'fixed' backgrounds (for example due to limitations of the hardware platform) should ignore declarations with the keyword 'fixed'. For example:

```
body {
  background: white url(paper.png) scroll; /* for all UAs */
  background: white url(ledger.png) fixed; /* for UAs that do fixed backgrounds */
}
```

See the section on conformance [p. 47] for details.

'background-position'

<i>Value:</i>	[[<percentage> <length> left center right] [<percentage> <length> top center bottom]?] [[left center right] [top center bottom]] inherit
<i>Initial:</i>	0% 0%
<i>Applies to:</i>	all elements
<i>Inherited:</i>	no
<i>Percentages:</i>	refer to the size of the box itself
<i>Media:</i>	visual
<i>Computed value:</i>	for <length> the absolute value, otherwise a percentage

If a background image has been specified, this property specifies its initial position. If only one value is specified, the second value is assumed to be 'center'. If at least one value is not a keyword, then the first value represents the horizontal position and the second represents the vertical position. Negative <percentage> and <length> values are allowed.

<percentage>

A percentage X aligns the point X% across (for horizontal) or down (for vertical) the image with the point X% across (for horizontal) or down (for vertical) the element's padding box. For example, with a value pair of '0% 0%', the upper left corner of the image is aligned with the upper left corner of the padding box. A value pair of '100% 100%' places the lower right corner of the image in the lower right corner of the padding box. With a value pair of '14% 84%', the point

14% across and 84% down the image is to be placed at the point 14% across and 84% down the padding box.

<length>

A length L aligns the top left corner of the image a distance L to the right of (for horizontal) or below (for vertical) the top left corner of the element's padding box. For example, with a value pair of '2cm 1cm', the upper left corner of the image is placed 2cm to the right and 1cm below the upper left corner of the padding box.

top

Equivalent to '0%' for the vertical position.

right

Equivalent to '100%' for the horizontal position.

bottom

Equivalent to '100%' for the vertical position.

left

Equivalent to '0%' for the horizontal position.

center

Equivalent to '50%' for the horizontal position if it is not otherwise given, or '50%' for the vertical position if it is.

Example(s):

```
body { background: url("banner.jpeg") right top } /* 100% 0% */
body { background: url("banner.jpeg") top center } /* 50% 0% */
body { background: url("banner.jpeg") center } /* 50% 50% */
body { background: url("banner.jpeg") bottom } /* 50% 100% */
```

The tiling and positioning of the background-image on inline elements is undefined in this specification. A future level of CSS may define the tiling and positioning of the background-image on inline elements.

If the background image is fixed within the viewport (see the 'background-attachment' property), the image is placed relative to the viewport instead of the element's padding box. For example,

Example(s):

```
body {
  background-image: url("logo.png");
  background-attachment: fixed;
  background-position: 100% 100%;
  background-repeat: no-repeat;
}
```

In the example above, the (single) image is placed in the lower-right corner of the viewport.

'background'

<i>Value:</i>	[<'background-color'> <'background-image'> <'background-repeat'> <'background-attachment'> <'background-position'>] inherit
<i>Initial:</i>	see individual properties
<i>Applies to:</i>	all elements
<i>Inherited:</i>	no
<i>Percentages:</i>	allowed on 'background-position'
<i>Media:</i>	visual
<i>Computed value:</i>	see individual properties

The 'background' property is a shorthand property for setting the individual background properties (i.e., 'background-color', 'background-image', 'background-repeat', 'background-attachment' and 'background-position') at the same place in the style sheet.

Given a valid declaration, the 'background' property first sets all the individual background properties to their initial values, then assigns explicit values given in the declaration.

Example(s):

In the first rule of the following example, only a value for 'background-color' has been given and the other individual properties are set to their initial value. In the second rule, all individual properties have been specified.

```
BODY { background: red }
P { background: url("chess.png") gray 50% repeat fixed }
```

14.3 Gamma correction

For information about gamma issues, please consult the Gamma Tutorial in the PNG specification ([PNG]).

Note. *In the computation of gamma correction, UAs displaying on a CRT may assume an ideal CRT and ignore any effects on apparent gamma caused by dithering. That means the minimal handling they need to do on current platforms is:*

PC using MS-Windows

none

Unix using X11

none

Mac using QuickDraw

apply gamma 1.45 [ICC42] (ColorSync-savvy applications may simply pass the sRGB ICC profile to ColorSync to perform correct color correction)

SGI using X

apply the gamma value from `/etc/config/system.glGammaVal` (the default value being 1.70; applications running on Irix 6.2 or above may simply pass the sRGB ICC profile to the color management system)

NeXT using NeXTStep
apply gamma 2.22

"Applying gamma" means that each of the three R, G and B must be converted to $R'=R^{\text{gamma}}$, $G'=G^{\text{gamma}}$, $B'=B^{\text{gamma}}$, before being handed to the OS.

This may be done rapidly by building a 256-element lookup table once per browser invocation thus:

```
for i := 0 to 255 do
  raw := i / 255.0;
  corr := pow (raw, gamma);
  table[i] := trunc (0.5 + corr * 255.0)
end
```

which then avoids any need to do transcendental math per color attribute, far less per pixel.

15 Fonts

Contents

15.1 Introduction	241
15.2 Font matching algorithm	241
15.3 Font family: the 'font-family' property	242
15.3.1 Generic font families	244
15.3.1.1 <i>serif</i>	244
15.3.1.2 <i>sans-serif</i>	245
15.3.1.3 <i>cursive</i>	246
15.3.1.4 <i>fantasy</i>	246
15.3.1.5 <i>monospace</i>	246
15.4 Font styling: the 'font-style' property	247
15.5 Small-caps: the 'font-variant' property	247
15.6 Font boldness: the 'font-weight' property	248
15.7 Font size: the 'font-size' property	251
15.8 Shorthand font property: the 'font' property	253

15.1 Introduction

Setting font properties will be among the most common uses of style sheets. Unfortunately, there exists no well-defined and universally accepted taxonomy for classifying fonts, and terms that apply to one font family may not be appropriate for others. E.g., 'italic' is commonly used to label slanted text, but slanted text may also be labeled as being *Oblique*, *Slanted*, *Incline*, *Cursive* or *Kursiv*. Therefore it is not a simple problem to map typical font selection properties to a specific font.

15.2 Font matching algorithm

Because there is no accepted, universal taxonomy of font properties, matching of properties to font faces must be done carefully. The properties are matched in a well-defined order to insure that the results of this matching process are as consistent as possible across UAs (assuming that the same library of font faces is presented to each of them).

1. The User Agent makes (or accesses) a database of relevant CSS 2.1 properties of all the fonts of which the UA is aware. If there are two fonts with exactly the same properties, the user agent selects one of them.
2. At a given element and for each character in that element, the UA assembles the font properties applicable to that element. Using the complete set of properties, the UA uses the 'font-family' property to choose a tentative font family. The remaining properties are tested against the family according to the matching criteria described with each property. If there are matches for all the remaining

- properties, then that is the matching font face for the given element or character.
3. If there is no matching font face within the 'font-family' being processed by step 2, and if there is a next alternative 'font-family' in the font set, then repeat step 2 with the next alternative 'font-family'.
 4. If there is a matching font face, but it does not contain a glyph for the current character, and if there is a next alternative 'font-family' in the font sets, then repeat step 2 with the next alternative 'font-family'.
 5. If there is no font within the family selected in 2, then use a UA-dependent default 'font-family' and repeat step 2, using the best match that can be obtained within the default font. If a particular character cannot be displayed using this font, then the UA may use other means to determine a suitable font for that character. The UA should map each character for which it has no suitable font to a visible symbol chosen by the UA, preferably a "missing character" glyph from one of the font faces available to the UA.

(The above algorithm can be optimized to avoid having to revisit the CSS 2.1 properties for each character.)

The per-property matching rules from (2) above are as follows:

1. 'font-style' is tried first. 'italic' will be satisfied if there is either a face in the UA's font database labeled with the CSS keyword 'italic' (preferred) or 'oblique'. Otherwise the values must be matched exactly or font-style will fail.
2. 'font-variant' is tried next. 'small-caps' matches (1) a font labeled as 'small-caps', (2) a font in which the small caps are synthesized, or (3) a font where all lower-case letters are replaced by upper case letters. A small-caps font may be synthesized by electronically scaling uppercase letters from a normal font. 'normal' matches a font's normal (non-small-caps) variant. A font cannot fail to have a normal variant. A font that is only available as small-caps shall be selectable as either a 'normal' face or a 'small-caps' face.
3. 'font-weight' is matched next, it will never fail. (See 'font-weight' below.)
4. 'font-size' must be matched within a UA-dependent margin of tolerance. (Typically, sizes for scalable fonts are rounded to the nearest whole pixel, while the tolerance for bitmapped fonts could be as large as 20%.) Further computations, e.g., by 'em' values in other properties, are based on the computed value of 'font-size'.

15.3 Font family: the 'font-family' property

'font-family'

<i>Value:</i>	[[<family-name> <generic-family>] [, <family-name> <generic-family>]*] inherit
<i>Initial:</i>	depends on user agent
<i>Applies to:</i>	all elements
<i>Inherited:</i>	yes
<i>Percentages:</i>	N/A
<i>Media:</i>	visual
<i>Computed value:</i>	as specified

The property value is a prioritized list of font family names and/or generic family names. [p. 244] Unlike most other CSS properties, component values are separated by a comma to indicate that they are alternatives:

```
body { font-family: Gill, Helvetica, sans-serif }
```

Although many fonts provide the "missing character" glyph, typically an open box, as its name implies this should not be considered a match for characters that cannot be found in the font. (It should, however, be considered a match for U+FFFD, the "missing character" character's code point).

There are two types of font family names:

<family-name>

The name of a font family of choice. In the last example, "Gill" and "Helvetica" are font families.

<generic-family>

In the example above, the last value is a generic family name. The following generic families are defined:

- 'serif' (e.g., Times)
- 'sans-serif' (e.g., Helvetica)
- 'cursive' (e.g., Zapf-Chancery)
- 'fantasy' (e.g., Western)
- 'monospace' (e.g., Courier)

Style sheet designers are encouraged to offer a generic font family as a last alternative. Generic font family names are keywords and must NOT be quoted.

Font family names must either be given quoted as strings, [p. 70] or unquoted as a sequence of one or more identifiers. [p. 55] This means most punctuation characters and digits at the start of each token must be escaped in unquoted font family names.

For example, the following declarations are invalid:

```
font-family: Red/Black, sans-serif;
font-family: "Lucida" Grande, sans-serif;
font-family: Ahem!, sans-serif;
font-family: test@foo, sans-serif;
font-family: #POUND, sans-serif;
font-family: Hawaii 5-0, sans-serif;
```

If a sequence of identifiers is given as a font family name, the computed value is the name converted to a string by joining all the identifiers in the sequence by single spaces.

To avoid mistakes in escaping, it is recommended to quote font family names that contain white space, digits, or punctuation characters other than hyphens:

```
body { font-family: "New Century Schoolbook", serif }
<BODY STYLE="font-family: '21st Century', fantasy">
```

Font family *names* that happen to be the same as a keyword value ('inherit', 'serif', 'sans-serif', 'monospace', 'fantasy', and 'cursive') must be quoted to prevent confusion with the keywords with the same names. The keywords 'initial' and 'default' are reserved for future use and must also be quoted when used as font names. UAs must not consider these keywords as matching the '<family-name>' type.

15.3.1 Generic font families

Generic font families are a fallback mechanism, a means of preserving some of the style sheet author's intent in the worst case when none of the specified fonts can be selected. For optimum typographic control, particular named fonts should be used in style sheets.

All five generic font families are defined to exist in all CSS implementations (they need not necessarily map to five distinct actual fonts). User agents should provide reasonable default choices for the generic font families, which express the characteristics of each family as well as possible within the limits allowed by the underlying technology.

User agents are encouraged to allow users to select alternative choices for the generic fonts.

15.3.1.1 *serif*

Glyphs of serif fonts, as the term is used in CSS, tend to have finishing strokes, flared or tapering ends, or have actual serified endings (including slab serifs). Serif fonts are typically proportionately-spaced. They often display a greater variation between thick and thin strokes than fonts from the 'sans-serif' generic font family. CSS uses the term 'serif' to apply to a font for any script, although other names may be more familiar for particular scripts, such as Mincho (Japanese), Sung or Song (Chinese), Totum or Kodig (Korean). Any font that is so described may be used to represent the generic 'serif' family.

Examples of fonts that fit this description include:

Latin fonts	Times New Roman, Bodoni, Garamond, Minion Web, ITC Stone Serif, MS Georgia, Bitstream Cyberbit
Greek fonts	Bitstream Cyberbit
Cyrillic fonts	Adobe Minion Cyrillic, Excelsior Cyrillic Upright, Monotype Albion 70, Bitstream Cyberbit, ER Bukinist
Hebrew fonts	New Peninim, Raanana, Bitstream Cyberbit
Japanese fonts	Ryumin Light-KL, Kyokasho ICA, Futo Min A101
Arabic fonts	Bitstream Cyberbit
Cherokee fonts	Lo Cicero Cherokee

15.3.1.2 *sans-serif*

Glyphs in sans-serif fonts, as the term is used in CSS, tend to have stroke endings that are plain -- with little or no flaring, cross stroke, or other ornamentation. Sans-serif fonts are typically proportionately-spaced. They often have little variation between thick and thin strokes, compared to fonts from the 'serif' family. CSS uses the term 'sans-serif' to apply to a font for any script, although other names may be more familiar for particular scripts, such as Gothic (Japanese), Kai (Chinese), or Pathang (Korean). Any font that is so described may be used to represent the generic 'sans-serif' family.

Examples of fonts that fit this description include:

Latin fonts	MS Trebuchet, ITC Avant Garde Gothic, MS Arial, MS Verdana, Univers, Futura, ITC Stone Sans, Gill Sans, Akzidenz Grotesk, Helvetica
Greek fonts	Attika, Typiko New Era, MS Tahoma, Monotype Gill Sans 571, Helvetica Greek
Cyrillic fonts	Helvetica Cyrillic, ER Univers, Lucida Sans Unicode, Bastion
Hebrew fonts	Arial Hebrew, MS Tahoma
Japanese fonts	Shin Go, Heisei Kaku Gothic W5
Arabic fonts	MS Tahoma

15.3.1.3 *cursive*

Glyphs in cursive fonts, as the term is used in CSS, generally have either joining strokes or other cursive characteristics beyond those of italic typefaces. The glyphs are partially or completely connected, and the result looks more like handwritten pen or brush writing than printed letterwork. Fonts for some scripts, such as Arabic, are almost always cursive. CSS uses the term 'cursive' to apply to a font for any script, although other names such as Chancery, Brush, Swing and Script are also used in font names.

Examples of fonts that fit this description include:

Latin fonts	Caflich Script, Adobe Poetica, Sanvito, Ex Ponto, Snell Round-hand, Zapf-Chancery
Cyrillic fonts	ER Architekt
Hebrew fonts	Corsiva
Arabic fonts	DecoType Naskh, Monotype Urdu 507

15.3.1.4 *fantasy*

Fantasy fonts, as used in CSS, are primarily decorative while still containing representations of characters (as opposed to Pi or Picture fonts, which do not represent characters). Examples include:

Latin fonts Alpha Geometrique, Critter, Cottonwood, FB Reactor, Studz

15.3.1.5 *monospace*

The sole criterion of a monospace font is that all glyphs have the same fixed width. (This can make some scripts, such as Arabic, look most peculiar.) The effect is similar to a manual typewriter, and is often used to set samples of computer code.

Examples of fonts which fit this description include:

Latin fonts	Courier, MS Courier New, Prestige, Everson Mono
Greek Fonts	MS Courier New, Everson Mono
Cyrillic fonts	ER Kurier, Everson Mono
Japanese fonts	Osaka Monospaced
Cherokee fonts	Everson Mono

15.4 Font styling: the 'font-style' property

'font-style'

<i>Value:</i>	normal italic oblique inherit
<i>Initial:</i>	normal
<i>Applies to:</i>	all elements
<i>Inherited:</i>	yes
<i>Percentages:</i>	N/A
<i>Media:</i>	visual
<i>Computed value:</i>	as specified

The 'font-style' property selects between normal (sometimes referred to as "roman" or "upright"), italic and oblique faces within a font family.

A value of 'normal' selects a font that is classified as 'normal' in the UA's font database, while 'oblique' selects a font that is labeled 'oblique'. A value of 'italic' selects a font that is labeled 'italic', or, if that is not available, one labeled 'oblique'.

The font that is labeled 'oblique' in the UA's font database may actually have been generated by electronically slanting a normal font.

Fonts with Oblique, Slanted or Incline in their names will typically be labeled 'oblique' in the UA's font database. Fonts with *Italic*, *Cursive* or *Kursiv* in their names will typically be labeled 'italic'.

```
h1, h2, h3 { font-style: italic }
h1 em { font-style: normal }
```

In the example above, emphasized text within 'H1' will appear in a normal face.

15.5 Small-caps: the 'font-variant' property

'font-variant'

<i>Value:</i>	normal small-caps inherit
<i>Initial:</i>	normal
<i>Applies to:</i>	all elements
<i>Inherited:</i>	yes
<i>Percentages:</i>	N/A
<i>Media:</i>	visual
<i>Computed value:</i>	as specified

Another type of variation within a font family is the small-caps. In a small-caps font the lower case letters look similar to the uppercase ones, but in a smaller size and with slightly different proportions. The 'font-variant' property selects that font.

A value of 'normal' selects a font that is not a small-caps font, 'small-caps' selects a small-caps font. It is acceptable (but not required) in CSS 2.1 if the small-caps font is a created by taking a normal font and replacing the lower case letters by scaled uppercase characters. As a last resort, uppercase letters will be used as replacement for a small-caps font.

The following example results in an 'H3' element in small-caps, with any emphasized words in oblique, and any emphasized words within an 'H3' oblique small-caps:

```
h3 { font-variant: small-caps }
em { font-style: oblique }
```

There may be other variants in the font family as well, such as fonts with old-style numerals, small-caps numerals, condensed or expanded letters, etc. CSS 2.1 has no properties that select those.

Note: insofar as this property causes text to be transformed to uppercase, the same considerations as for 'text-transform' apply.

15.6 Font boldness: the 'font-weight' property

'font-weight'

<i>Value:</i>	normal bold bolder lighter 100 200 300 400 500 600 700 800 900 inherit
<i>Initial:</i>	normal
<i>Applies to:</i>	all elements
<i>Inherited:</i>	yes
<i>Percentages:</i>	N/A
<i>Media:</i>	visual
<i>Computed value:</i>	see text

The 'font-weight' property selects the weight of the font. The values '100' to '900' form an ordered sequence, where each number indicates a weight that is at least as dark as its predecessor. The keyword 'normal' is synonymous with '400', and 'bold' is synonymous with '700'. Keywords other than 'normal' and 'bold' have been shown to be often confused with font names and a numerical scale was therefore chosen for the 9-value list.

```
p { font-weight: normal } /* 400 */
h1 { font-weight: 700 } /* bold */
```

The 'bolder' and 'lighter' values select font weights that are relative to the weight inherited from the parent:

```
strong { font-weight: bolder }
```

Fonts (the font data) typically have one or more properties whose values are names that are descriptive of the "weight" of a font. There is no accepted, universal meaning to these weight names. Their primary role is to distinguish faces of differing darkness within a single font family. Usage across font families is quite variant; for example, a font that one might think of as being bold might be described as being *Regular*, *Roman*, *Book*, *Medium*, *Semi-* or *DemiBold*, *Bold*, or *Black*, depending on how black the "normal" face of the font is within the design. Because there is no standard usage of names, the weight property values in CSS 2.1 are given on a numerical scale in which the value '400' (or 'normal') corresponds to the "normal" text face for that family. The weight name associated with that face will typically be *Book*, *Regular*, *Roman*, *Normal* or sometimes *Medium*.

The association of other weights within a family to the numerical weight values is intended only to preserve the ordering of darkness within that family. However, the following heuristics tell how the assignment is done in this case:

- If the font family already uses a numerical scale with nine values (like e.g., *OpenType* does), the font weights should be mapped directly.
- If there is both a face labeled *Medium* and one labeled *Book*, *Regular*, *Roman* or *Normal*, then the *Medium* is normally assigned to the '500'.
- The font labeled "Bold" will often correspond to the weight value '700'.

Once the font family's weights are mapped onto the CSS scale, missing weights are selected as follows:

- If the desired weight is less than 400, weights below the desired weight are checked in descending order followed by weights above the desired weight in ascending order until a match is found.
- If the desired weight is greater than 500, weights above desired weight are checked in ascending order followed by weights below the desired weight in descending order until a match is found.
- If the desired weight is 400, 500 is checked first and then the rule for desired weights less than 400 is used.
- If the desired weight is 500, 400 is checked first and then the rule for desired weights less than 400 is used.

The following two examples show typical mappings.

Assume four weights in the "Rattlesnake" family, from lightest to darkest: *Regular*, *Medium*, *Bold*, *Heavy*.

First example of font-weight mapping

Available faces	Assignments	Filling the holes
"Rattlesnake Regular"	400	100, 200, 300
"Rattlesnake Medium"	500	
"Rattlesnake Bold"	700	600
"Rattlesnake Heavy"	800	900

Assume six weights in the "Ice Prawn" family: *Book, Medium, Bold, Heavy, Black, ExtraBlack*. Note that in this instance the user agent has decided *not* to assign a numeric value to "Ice Prawn ExtraBlack".

Second example of font-weight mapping

Available faces	Assignments	Filling the holes
"Ice Prawn Book"	400	100, 200, 300
"Ice Prawn Medium"	500	
"Ice Prawn Bold"	700	600
"Ice Prawn Heavy"	800	
"Ice Prawn Black"	900	
"Ice Prawn ExtraBlack"	(none)	

Values of 'bolder' and 'lighter' indicate values relative to the weight of the parent element. Based on the inherited weight value, the weight used is calculated using the chart below. Child elements inherit the calculated weight, not a value of 'bolder' or 'lighter'.

The meaning of 'bolder' and 'lighter'

Inherited value	bolder	lighter
100	400	100
200	400	100
300	400	100
400	700	100
500	700	100
600	900	400
700	900	400
800	900	700
900	900	700

The table above is equivalent to selecting the next relative bolder or lighter face, given a font family containing normal and bold faces along with a thin and a heavy face. Authors who desire finer control over the exact weight values used for a given element should use numerical values instead of relative weights.

There is no guarantee that there will be a darker face for each of the 'font-weight' values; for example, some fonts may have only a normal and a bold face, while others may have eight face weights. There is no guarantee on how a UA will map font faces within a family to weight values. The only guarantee is that a face of a given value will be no less dark than the faces of lighter values.

Note: A set of nested elements that mix 'bolder' and 'lighter' will give unpredictable results depending on the UA, OS, and font availability. This behavior will be more precisely defined in CSS3.

CSS 2.1 does not specify how the computed value of font-weight is represented internally or externally.

15.7 Font size: the 'font-size' property

'font-size'

Value: <absolute-size> | <relative-size> | <length> | <percentage> | inherit
Initial: medium
Applies to: all elements
Inherited: yes
Percentages: refer to inherited font size
Media: visual
Computed value: absolute length

The font size corresponds to the em square, a concept used in typography. Note that certain glyphs may bleed outside their em squares. Values have the following meanings:

<absolute-size>

An <absolute-size> keyword is an index to a table of font sizes computed and kept by the UA. Possible values are:

[xx-small | x-small | small | medium | large | x-large | xx-large]

The following table provides user agent guidelines for the absolute-size mapping to HTML heading and absolute font-sizes. The 'medium' value is the user's preferred font size and is used as the reference middle value.

CSS absolute-size values	xx-small	x-small	small	medium	large	x-large	xx-large	
HTML font sizes	1		2	3	4	5	6	7

Implementors should build a table of scaling factors for absolute-size keywords relative to the 'medium' font size and the particular device and its characteristics (e.g., the resolution of the device).

Different media may need different scaling factors. Also, the UA should take the quality and availability of fonts into account when computing the table. The table may be different from one font family to another.

Note 1. To preserve readability, a UA applying these guidelines should nevertheless avoid creating font-size resulting in less than 9 pixels per EM unit on a computer display.

Note 2. In CSS1, the suggested scaling factor between adjacent indexes was 1.5, which user experience proved to be too large. In CSS2, the suggested scaling factor for a computer screen between adjacent indexes was 1.2, which still created issues for the small sizes. Implementation experience has demonstrated that a fixed ratio between adjacent absolute-size keywords is problematic, and this specification does not recommend such a fixed ratio.

<relative-size>

A <relative-size> keyword is interpreted relative to the table of font sizes and the font size of the parent element. Possible values are: [larger | smaller]. For example, if the parent element has a font size of 'medium', a value of 'larger' will make the font size of the current element be 'large'. If the parent element's size is not close to a table entry, the UA is free to interpolate between table entries or round off to the closest one. The UA may have to extrapolate table values if the numerical value goes beyond the keywords.

Length and percentage values should not take the font size table into account when calculating the font size of the element.

Negative values are not allowed.

On all other properties, 'em' and 'ex' length values refer to the computed font size of the current element. On the 'font-size' property, these length units refer to the computed font size of the parent element.

Note that an application may reinterpret an explicit size, depending on the context. E.g., inside a VR scene a font may get a different size because of perspective distortion.

Examples:

```
p { font-size: 16px; }
@media print {
  p { font-size: 12pt; }
}
blockquote { font-size: larger }
em { font-size: 150% }
em { font-size: 1.5em }
```

15.8 Shorthand font property: the 'font' property

'font'

Value: [[<'font-style'> || <'font-variant'> || <'font-weight'>]? <'font-size'> [/ <'line-height'>]? <'font-family'>] | caption | icon | menu | message-box | small-caption | status-bar | inherit

Initial: see individual properties

Applies to: all elements

Inherited: yes

Percentages: see individual properties

Media: visual

Computed value: see individual properties

The 'font' property is, except as described below [p. 255], a shorthand property for setting 'font-style', 'font-variant', 'font-weight', 'font-size', 'line-height' and 'font-family' at the same place in the style sheet. The syntax of this property is based on a tradi-

tional typographical shorthand notation to set multiple properties related to fonts.

All font-related properties are first reset to their initial values, including those listed in the preceding paragraph. Then, those properties that are given explicit values in the 'font' shorthand are set to those values. For a definition of allowed and initial values, see the previously defined properties.

```
p { font: 12px/14px sans-serif }
p { font: 80% sans-serif }
p { font: x-large/110% "New Century Schoolbook", serif }
p { font: bold italic large Palatino, serif }
p { font: normal small-caps 120%/120% fantasy }
```

In the second rule, the font size percentage value ('80%') refers to the font size of the parent element. In the third rule, the line height percentage refers to the font size of the element itself.

In the first three rules above, the 'font-style', 'font-variant' and 'font-weight' are not explicitly mentioned, which means they are all three set to their initial value ('normal'). The fourth rule sets the 'font-weight' to 'bold', the 'font-style' to 'italic' and implicitly sets 'font-variant' to 'normal'.

The fifth rule sets the 'font-variant' ('small-caps'), the 'font-size' (120% of the parent's font), the 'line-height' (120% times the font size) and the 'font-family' ('fantasy'). It follows that the keyword 'normal' applies to the two remaining properties: 'font-style' and 'font-weight'.

The following values refer to system fonts:

caption

The font used for captioned controls (e.g., buttons, drop-downs, etc.).

icon

The font used to label icons.

menu

The font used in menus (e.g., dropdown menus and menu lists).

message-box

The font used in dialog boxes.

small-caption

The font used for labeling small controls.

status-bar

The font used in window status bars.

System fonts may only be set as a whole; that is, the font family, size, weight, style, etc. are all set at the same time. These values may then be altered individually if desired. If no font with the indicated characteristics exists on a given platform, the user agent should either intelligently substitute (e.g., a smaller version of the 'caption' font might be used for the 'small-caption' font), or substitute a user agent default font. As for regular fonts, if, for a system font, any of the individual properties are not part of the operating system's available user preferences, those properties should be set to their initial values.

That is why this property is "almost" a shorthand property: system fonts can only be specified with this property, not with 'font-family' itself, so 'font' allows authors to do more than the sum of its subproperties. However, the individual properties such as 'font-weight' are still given values taken from the system font, which can be independently varied.

Example(s):

```
button { font: 300 italic 1.3em/1.7em "FB Armada", sans-serif }
button p { font: menu }
button p em { font-weight: bolder }
```

If the font used for dropdown menus on a particular system happened to be, for example, 9-point Charcoal, with a weight of 600, then P elements that were descendants of BUTTON would be displayed as if this rule were in effect:

```
button p { font: 600 9px Charcoal }
```

Because the 'font' shorthand property resets any property not explicitly given a value to its initial value, this has the same effect as this declaration:

```
button p {
  font-family: Charcoal;
  font-style: normal;
  font-variant: normal;
  font-weight: 600;
  font-size: 9px;
  line-height: normal;
}
```

16 Text

Contents

16.1 Indentation: the 'text-indent' property	257
16.2 Alignment: the 'text-align' property	258
16.3 Decoration	259
16.3.1 Underlining, overlining, striking, and blinking: the 'text-decoration' property	259
16.4 Letter and word spacing: the 'letter-spacing' and 'word-spacing' properties	262
16.5 Capitalization: the 'text-transform' property	263
16.6 White space: the 'white-space' property	264
16.6.1 The 'white-space' processing model	265
16.6.2 Example of bidirectionality with white space collapsing	266
16.6.3 Control and combining characters' details	267

The properties defined in the following sections affect the visual presentation of characters, spaces, words, and paragraphs.

16.1 Indentation: the 'text-indent' property

'text-indent'

<i>Value:</i>	<length> <percentage> inherit
<i>Initial:</i>	0
<i>Applies to:</i>	block containers
<i>Inherited:</i>	yes
<i>Percentages:</i>	refer to width of containing block
<i>Media:</i>	visual
<i>Computed value:</i>	the percentage as specified or the absolute length

This property specifies the indentation of the first line of text in a block container. More precisely, it specifies the indentation of the first box that flows into the block's first line box [p. 139] . The box is indented with respect to the left (or right, for right-to-left layout) edge of the line box. User agents must render this indentation as blank space.

'Text-indent' only affects a line if it is the first formatted line [p. 92] of an element. For example, the first line of an anonymous block box is only affected if it is the first child of its parent element.

Values have the following meanings:

<length>

The indentation is a fixed length.

<percentage>

The indentation is a percentage of the containing block width.

The value of 'text-indent' may be negative, but there may be implementation-specific limits. If the value of 'text-indent' is either negative or exceeds the width of the block, that *first box*, described above, can overflow the block. The value of 'overflow' will affect whether such text that overflows the block is visible.

Example(s):

The following example causes a '3em' text indent.

```
p { text-indent: 3em }
```

Note: Since the 'text-indent' property inherits, when specified on a block element, it will affect descendant inline-block elements. For this reason, it is often wise to specify 'text-indent: 0' on elements that are specified 'display:inline-block'.

16.2 Alignment: the 'text-align' property

'text-align'

<i>Value:</i>	left right center justify inherit
<i>Initial:</i>	a nameless value that acts as 'left' if 'direction' is 'ltr', 'right' if 'direction' is 'rtl'
<i>Applies to:</i>	block containers
<i>Inherited:</i>	yes
<i>Percentages:</i>	N/A
<i>Media:</i>	visual
<i>Computed value:</i>	the initial value or as specified

This property describes how inline-level content of a block container is aligned. Values have the following meanings:

left, right, center, justify

Left, right, center, and justify text, respectively, as described in the section on inline formatting [p. 139] .

A block of text is a stack of line boxes [p. 139] . In the case of 'left', 'right' and 'center', this property specifies how the inline-level boxes within each line box align with respect to the line box's left and right sides; alignment is not with respect to the viewport [p. 128] . In the case of 'justify', this property specifies that the inline-level boxes are to be made flush with both sides of the block container if possible, by expanding or contracting the contents of inline boxes, else aligned as for the initial value. (See also 'letter-spacing' and 'word-spacing'.)

If an element has a computed value for 'white-space' of 'pre' or 'pre-wrap', then neither the glyphs of that element's text content nor its white space may be altered for the purpose of justification.

Example(s):

In this example, note that since 'text-align' is inherited, all block-level elements inside DIV elements with a class name of 'important' will have their inline content centered.

```
div.important { text-align: center }
```

Note. *The actual justification algorithm used depends on the user-agent and the language/script of the text.*

Conforming user agents [p. 47] may interpret the value 'justify' as 'left' or 'right', depending on whether the element's default writing direction is left-to-right or right-to-left, respectively.

16.3 Decoration

16.3.1 Underlining, overlining, striking, and blinking: the 'text-decoration' property

'text-decoration'

<i>Value:</i>	none [underline overline line-through blink] inherit
<i>Initial:</i>	none
<i>Applies to:</i>	all elements
<i>Inherited:</i>	no (see prose)
<i>Percentages:</i>	N/A
<i>Media:</i>	visual
<i>Computed value:</i>	as specified

This property describes decorations that are added to the text of an element using the element's color. When specified on or propagated to an inline element, it affects all the boxes generated by that element, and is further propagated to any in-flow block-level boxes that split the inline (see section 9.2.1.1 [p. 129]). For block containers that establish an inline formatting context, [p. 139] the decorations are propagated to an anonymous inline element that wraps all the in-flow inline-level children of the block container. For all other elements it is propagated to any in-flow children. Note that text decorations are not propagated to floating and absolutely positioned descendants, nor to the contents of atomic inline-level descendants such as inline blocks and inline tables.

Underlines, overlines, and line-throughs are applied only to text (including white space, letter spacing, and word spacing): margins, borders, and padding are skipped. User agents must not render these text decorations on content that is not

text. For example, images and inline blocks must not be underlined.

Note. *If an element E has both 'visibility: hidden' and 'text-decoration: underline', the underline is invisible (although any decoration of E's parent **is** visible.) However, CSS 2.1 does not specify if the underline is visible or invisible in E's children:*

```
<span style="visibility: hidden; text-decoration: underline">
  <span style="visibility: visible">
    underlined or not?
  </span>
</span>
```

This is expected to be specified in level 3 of CSS.

The 'text-decoration' property on descendant elements cannot have any effect on the decoration of the ancestor. In determining the position of and thickness of text decoration lines, user agents may consider the font sizes of and dominant baselines of descendants, but must use the same baseline and thickness on each line. Relatively positioning a descendant moves all text decorations affecting it along with the descendant's text; it does not affect calculation of the decoration's initial position on that line.

Values have the following meanings:

none

Produces no text decoration.

underline

Each line of text is underlined.

overline

Each line of text has a line above it.

line-through

Each line of text has a line through the middle.

blink

Text blinks (alternates between visible and invisible). Conforming user agents [p. 47] may simply not blink the text. Note that not blinking the text is one technique to satisfy checkpoint 3.3 of WAI-UAAG [p. ??] .

The color(s) required for the text decoration must be derived from the 'color' property value of the element on which 'text-decoration' is set. The color of decorations must remain the same even if descendant elements have different 'color' values.

Some user agents have implemented text-decoration by propagating the decoration to the descendant elements as opposed to preserving a constant thickness and line position as described above. This was arguably allowed by the looser wording in CSS2. SVG1, CSS1-only, and CSS2-only user agents may implement the older model and still claim conformance to this part of CSS 2.1. (This does not apply to UAs developed after this specification was released.)

Example(s):

In the following example for HTML, the text content of all A elements acting as hyperlinks (whether visited or not) will be underlined:

```
a:visited,a:link { text-decoration: underline }
```

Example(s):

In the following style sheet and document fragment:

```
blockquote { text-decoration: underline; color: blue; }
em { display: block; }
cite { color: fuchsia; }

<blockquote>
  <p>
    <span>
      Help, help!
      <em> I am under a hat! </em>
      <cite> -GwieF </cite>
    </span>
  </p>
</blockquote>
```

...the underlining for the blockquote element is propagated to an anonymous inline element that surrounds the span element, causing the text "Help, help!" to be blue, with the blue underlining from the anonymous inline underneath it, the color being taken from the blockquote element. The `text` in the em block is also underlined, as it is in an in-flow block to which the underline is propagated. The final line of text is fuchsia, but the underline underneath it is still the blue underline from the anonymous inline element.



This diagram shows the boxes involved in the example above. The rounded aqua line represents the anonymous inline element wrapping the inline contents of the paragraph element, the rounded blue line represents the span element, and the orange lines represent the blocks.

16.4 Letter and word spacing: the 'letter-spacing' and 'word-spacing' properties

'letter-spacing'

<i>Value:</i>	normal <length> inherit
<i>Initial:</i>	normal
<i>Applies to:</i>	all elements
<i>Inherited:</i>	yes
<i>Percentages:</i>	N/A
<i>Media:</i>	visual
<i>Computed value:</i>	'normal' or absolute length

This property specifies spacing behavior between text characters. Values have the following meanings:

normal

The spacing is the normal spacing for the current font. This value allows the user agent to alter the space between characters in order to justify text.

<length>

This value indicates inter-character space *in addition to* the default space between characters. Values may be negative, but there may be implementation-specific limits. User agents may not further increase or decrease the inter-character space in order to justify text.

Character spacing algorithms are user agent-dependent.

Example(s):

In this example, the space between characters in BLOCKQUOTE elements is increased by '0.1em'.

```
blockquote { letter-spacing: 0.1em }
```

In the following example, the user agent is not permitted to alter inter-character space:

```
blockquote { letter-spacing: 0cm } /* Same as '0' */
```

When the resultant space between two characters is not the same as the default space, user agents should not use ligatures.

'word-spacing'

<i>Value:</i>	normal <length> inherit
<i>Initial:</i>	normal
<i>Applies to:</i>	all elements
<i>Inherited:</i>	yes
<i>Percentages:</i>	N/A
<i>Media:</i>	visual
<i>Computed value:</i>	for 'normal' the value '0'; otherwise the absolute length

This property specifies spacing behavior between words. Values have the following meanings:

normal

The normal inter-word space, as defined by the current font and/or the UA.

<length>

This value indicates inter-word space *in addition to* the default space between words. Values may be negative, but there may be implementation-specific limits.

Word spacing algorithms are user agent-dependent. Word spacing is also influenced by justification (see the 'text-align' property). Word spacing affects each space (U+0020) and non-breaking space (U+00A0), left in the text after the white space processing rules have been applied. The effect of the property on other word-separator characters is undefined. However general punctuation, characters with zero advance width (such as the zero with space U+200B) and fixed-width spaces (such as U+3000 and U+2000 through U+200A) are not affected.

Example(s):

In this example, the word-spacing between each word in H1 elements is increased by '1em'.

```
h1 { word-spacing: 1em }
```

16.5 Capitalization: the 'text-transform' property

'text-transform'

<i>Value:</i>	capitalize uppercase lowercase none inherit
<i>Initial:</i>	none
<i>Applies to:</i>	all elements
<i>Inherited:</i>	yes
<i>Percentages:</i>	N/A
<i>Media:</i>	visual
<i>Computed value:</i>	as specified

This property controls capitalization effects of an element's text. Values have the following meanings:

capitalize

Puts the first character of each word in uppercase; other characters are unaffected.

uppercase

Puts all characters of each word in uppercase.

lowercase

Puts all characters of each word in lowercase.

none

No capitalization effects.

The actual transformation in each case is written language dependent. See BCP 47 ([BCP47]) for ways to find the language of an element.

Only characters belonging to "bicameral scripts" [UNICODE] are affected.

Example(s):

In this example, all text in an H1 element is transformed to uppercase text.

```
h1 { text-transform: uppercase }
```

16.6 White space: the 'white-space' property

'white-space'

<i>Value:</i>	normal pre nowrap pre-wrap pre-line inherit
<i>Initial:</i>	normal
<i>Applies to:</i>	all elements
<i>Inherited:</i>	yes
<i>Percentages:</i>	N/A
<i>Media:</i>	visual
<i>Computed value:</i>	as specified

This property declares how white space inside the element is handled. Values have the following meanings:

normal

This value directs user agents to collapse sequences of white space, and break lines as necessary to fill line boxes.

pre

This value prevents user agents from collapsing sequences of white space. Lines are only broken at newlines in the source, or at occurrences of "\A" in generated content.

nowrap

This value collapses white space as for 'normal', but suppresses line breaks within text.

pre-wrap

This value prevents user agents from collapsing sequences of white space.

Lines are broken at newlines in the source, at occurrences of "\A" in generated content, and as necessary to fill line boxes.

pre-line

This value directs user agents to collapse sequences of white space. Lines are broken at newlines in the source, at occurrences of "\A" in generated content, and as necessary to fill line boxes.

Newlines in the source can be represented by a carriage return (U+000D), a line-feed (U+000A) or both (U+000D U+000A) or by some other mechanism that identifies the beginning and end of document segments, such as the SGML RECORD-START and RECORD-END tokens. The CSS 'white-space' processing model assumes all newlines have been normalized to line feeds. UAs that recognize other newline representations must apply the white space processing rules as if this normalization has taken place. If no newline rules are specified for the document language, each carriage return (U+000D) and CRLF sequence (U+000D U+000A) in the document text is treated as single line feed character. This default normalization rule also applies to generated content.

Example(s):

The following examples show what white space [p. 53] behavior is expected from the PRE and P elements and the "nowrap" attribute in HTML.

```
pre      { white-space: pre }
p        { white-space: normal }
td[nowrap] { white-space: nowrap }
```

In addition, the effect of an HTML PRE element with the *non-standard* "wrap" attribute is demonstrated by the following example:

```
pre[wrap] { white-space: pre-wrap }
```

16.6.1 The 'white-space' processing model

For each inline element (including anonymous inline elements), the following steps are performed, treating bidi formatting characters as if they were not there:

1. Each tab (U+0009), carriage return (U+000D), or space (U+0020) character surrounding a linefeed (U+000A) character is removed if 'white-space' is set to 'normal', 'nowrap', or 'pre-line'.
2. If 'white-space' is set to 'pre' or 'pre-wrap', any sequence of spaces (U+0020) unbroken by an element boundary is treated as a sequence of non-breaking spaces. However, for 'pre-wrap', a line breaking opportunity exists at the end of the sequence.
3. If 'white-space' is set to 'normal' or 'nowrap', linefeed characters are transformed for rendering purpose into one of the following characters: a space character, a zero width space character (U+200B), or no character (i.e., not rendered), according to UA-specific algorithms based on the content script.
4. If 'white-space' is set to 'normal', 'nowrap', or 'pre-line',
 1. every tab (U+0009) is converted to a space (U+0020)

- any space (U+0020) following another space (U+0020) — even a space before the inline, if that space also has 'white-space' set to 'normal', 'nowrap' or 'pre-line' — is removed.

Then, the block container's inlines are laid out. Inlines are laid out, taking bidi reordering into account, and wrapping as specified by the 'white-space' property. When wrapping, line breaking opportunities are determined based on the text prior to the white space collapsing steps above.

As each line is laid out,

- If a space (U+0020) at the beginning of a line has 'white-space' set to 'normal', 'nowrap', or 'pre-line', it is removed.
- All tabs (U+0009) are rendered as a horizontal shift that lines up the start edge of the next glyph with the next tab stop. Tab stops occur at points that are multiples of 8 times the width of a space (U+0020) rendered in the block's font from the block's starting content edge.
- If a space (U+0020) at the end of a line has 'white-space' set to 'normal', 'nowrap', or 'pre-line', it is also removed.
- If spaces (U+0020) or tabs (U+0009) at the end of a line have 'white-space' set to 'pre-wrap', UAs may visually collapse them.

Floated and absolutely-positioned elements do not introduce a line breaking opportunity.

Note. *CSS 2.1 does not fully define where line breaking opportunities occur.*

16.6.2 Example of bidirectionality with white space collapsing

Given the following markup fragment, taking special note of spaces (with varied backgrounds and borders for emphasis and identification):

```
<ltr>A <rtl> B </rtl> C</ltr>
```

...where the `<ltr>` element represents a left-to-right embedding and the `<rtl>` element represents a right-to-left embedding, and assuming that the 'white-space' property is set to 'normal', the above processing model would result in the following:

- The space before the B () would collapse with the space after the A ().
- The space before the C () would collapse with the space after the B ().

This would leave two spaces, one after the A in the left-to-right embedding level, and one after the B in the right-to-left embedding level. This is then rendered according to the Unicode bidirectional algorithm, with the end result being:

```
A BC
```

Note that there are two spaces between A and B, and none between B and C. This can sometimes be avoided by using the natural bidirectionality of characters instead of explicit embedding levels. Also, it is good to avoid spaces immediately inside start and end tags, as these tend to do weird things when dealing with white space collapsing.

16.6.3 Control and combining characters' details

Control characters other than U+0009 (tab), U+000A (line feed), U+0020 (space), and U+202x (bidi formatting characters) are treated as characters to render in the same way as any normal character.

Combining characters should be treated as part of the character with which they are supposed to combine. For example, `:first-letter` styles the entire glyph if you have content like `"o#x308 ; "`; it does not just match the base character.

Text

17 Tables

Contents

17.1 Introduction to tables	269
17.2 The CSS table model	271
17.2.1 Anonymous table objects	273
17.3 Columns	275
17.4 Tables in the visual formatting model	276
17.4.1 Caption position and alignment	277
17.5 Visual layout of table contents	278
17.5.1 Table layers and transparency	279
17.5.2 Table width algorithms: the 'table-layout' property	282
17.5.2.1 Fixed table layout	283
17.5.2.2 Automatic table layout	284
17.5.3 Table height algorithms	285
17.5.4 Horizontal alignment in a column	287
17.5.5 Dynamic row and column effects	287
17.6 Borders	288
17.6.1 The separated borders model	288
17.6.1.1 Borders and Backgrounds around empty cells: the 'empty-cells' property	290
17.6.2 The collapsing border model	291
17.6.2.1 Border conflict resolution	292
17.6.3 Border styles	294

17.1 Introduction to tables

This chapter defines the processing model for tables in CSS. Part of this processing model is the layout. For the layout, this chapter introduces two algorithms; the first, the fixed table layout algorithm, is well-defined, but the second, the automatic table layout algorithm, is not fully defined by this specification.

For the automatic table layout algorithm, some widely deployed implementations have achieved relatively close interoperability.

Table layout can be used to represent tabular relationships between data. Authors specify these relationships in the document language [p. 44] and can specify their *presentation* using CSS 2.1.

In a visual medium, CSS tables can also be used to achieve specific layouts. In this case, authors should not use table-related elements in the document language, but should apply the CSS to the relevant structural elements to achieve the desired layout.

Authors may specify the visual formatting of a table as a rectangular grid of cells. Rows and columns of cells may be organized into row groups and column groups. Rows, columns, row groups, column groups, and cells may have borders drawn around them (there are two border models in CSS 2.1). Authors may align data vertically or horizontally within a cell and align data in all cells of a row or column.

Example(s):

Here is a simple three-row, three-column table described in HTML 4:

```
<TABLE>
<CAPTION>This is a simple 3x3 table</CAPTION>
<TR id="row1">
  <TH>Header 1  <TD>Cell 1  <TD>Cell 2
<TR id="row2">
  <TH>Header 2  <TD>Cell 3  <TD>Cell 4
<TR id="row3">
  <TH>Header 3  <TD>Cell 5  <TD>Cell 6
</TABLE>
```

This code creates one table (the TABLE element), three rows (the TR elements), three header cells (the TH elements), and six data cells (the TD elements). Note that the three columns of this example are specified implicitly: there are as many columns in the table as required by header and data cells.

The following CSS rule centers the text horizontally in the header cells and presents the text in the header cells with a bold font weight:

```
th { text-align: center; font-weight: bold }
```

The next rules align the text of the header cells on their baseline and vertically center the text in each data cell:

```
th { vertical-align: baseline }
td { vertical-align: middle }
```

The next rules specify that the top row will be surrounded by a 3px solid blue border and each of the other rows will be surrounded by a 1px solid black border:

```
table { border-collapse: collapse }
tr#row1 { border: 3px solid blue }
tr#row2 { border: 1px solid black }
tr#row3 { border: 1px solid black }
```

Note, however, that the borders around the rows overlap where the rows meet. What color (black or blue) and thickness (1px or 3px) will the border between row1 and row2 be? We discuss this in the section on border conflict resolution. [p. 292]

The following rule puts the table caption above the table:

```
caption { caption-side: top }
```

The preceding example shows how CSS works with HTML 4 elements; in HTML 4, the semantics of the various table elements (TABLE, CAPTION, THEAD, TBODY, TFOOT, COL, COLGROUP, TH, and TD) are well-defined. In other document

languages (such as XML applications), there may not be pre-defined table elements. Therefore, CSS 2.1 allows authors to "map" document language elements to table elements via the 'display' property. For example, the following rule makes the FOO element act like an HTML TABLE element and the BAR element act like a CAPTION element:

```
FOO { display : table }
BAR { display : table-caption }
```

We discuss the various table elements in the following section. In this specification, the term *table element* refers to any element involved in the creation of a table. An *internal table element* is one that produces a row, row group, column, column group, or cell.

17.2 The CSS table model

The CSS table model is based on the HTML4 table model, in which the structure of a table closely parallels the visual layout of the table. In this model, a table consists of an optional caption and any number of rows of cells. The table model is said to be "row primary" since authors specify rows, not columns, explicitly in the document language. Columns are derived once all the rows have been specified -- the first cell of each row belongs to the first column, the second to the second column, etc.). Rows and columns may be grouped structurally and this grouping reflected in presentation (e.g., a border may be drawn around a group of rows).

Thus, the table model consists of tables, captions, rows, row groups (including header groups and footer groups), columns, column groups, and cells.

The CSS model does not require that the document language [p. 44] include elements that correspond to each of these components. For document languages (such as XML applications) that do not have pre-defined table elements, authors must map document language elements to table elements; this is done with the 'display' property. The following 'display' values assign table formatting rules to an arbitrary element:

table (In HTML: TABLE)

Specifies that an element defines a block-level [p. 129] table: it is a rectangular block that participates in a block formatting context [p. 139] .

inline-table (In HTML: TABLE)

Specifies that an element defines an inline-level [p. 131] table: it is a rectangular block that participates in an inline formatting context [p. 139]).

table-row (In HTML: TR)

Specifies that an element is a row of cells.

table-row-group (In HTML: TBODY)

Specifies that an element groups one or more rows.

table-header-group (In HTML: THEAD)

Like 'table-row-group', but for visual formatting, the row group is always displayed before all other rows and row groups and after any top captions. Print user agents may repeat header rows on each page spanned by a table. If a

table contains multiple elements with 'display: table-header-group', only the first is rendered as a header; the others are treated as if they had 'display: table-row-group'.

table-footer-group (In HTML: TFOOT)

Like 'table-row-group', but for visual formatting, the row group is always displayed after all other rows and row groups and before any bottom captions. Print user agents may repeat footer rows on each page spanned by a table. If a table contains multiple elements with 'display: table-footer-group', only the first is rendered as a footer; the others are treated as if they had 'display: table-row-group'.

table-column (In HTML: COL)

Specifies that an element describes a column of cells.

table-column-group (In HTML: COLGROUP)

Specifies that an element groups one or more columns.

table-cell (In HTML: TD, TH)

Specifies that an element represents a table cell.

table-caption (In HTML: CAPTION)

Specifies a caption for the table. All elements with 'display: table-caption' must be rendered, as described in section 17.4. [p. 276]

Replaced elements with these 'display' values are treated as their given display types during layout. For example, an image that is set to 'display: table-cell' will fill the available cell space, and its dimensions might contribute towards the table sizing algorithms, as with an ordinary cell.

Elements with 'display' set to 'table-column' or 'table-column-group' are not rendered (exactly as if they had 'display: none'), but they are useful, because they may have attributes which induce a certain style for the columns they represent.

The default style sheet for HTML4 [p. 435] in the appendix illustrates the use of these values for HTML4:

```
table    { display: table }
tr       { display: table-row }
thead    { display: table-header-group }
tbody    { display: table-row-group }
tfoot    { display: table-footer-group }
col      { display: table-column }
colgroup { display: table-column-group }
td, th   { display: table-cell }
caption  { display: table-caption }
```

User agents may ignore [p. 60] these 'display' property values for HTML table elements, since HTML tables may be rendered using other algorithms intended for backwards compatible rendering. However, this is not meant to discourage the use of 'display: table' on other, non-table elements in HTML.

17.2.1 Anonymous table objects

Document languages other than HTML may not contain all the elements in the CSS 2.1 table model. In these cases, the "missing" elements must be assumed in order for the table model to work. Any table element will automatically generate necessary anonymous table objects around itself, consisting of at least three nested objects corresponding to a 'table'/inline-table' element, a 'table-row' element, and a 'table-cell' element. Missing elements generate anonymous [p. 132] objects (e.g., anonymous boxes in visual table layout) according to the following rules:

For the purposes of these rules, the following terms are defined:

row group box

A 'table-row-group', 'table-header-group', or 'table-footer-group'

proper table child

A 'table-row' box, row group box, 'table-column' box, 'table-column-group' box, or 'table-caption' box.

proper table row parent

A 'table' or 'inline-table' box or row group box

internal table box

A 'table-cell' box, 'table-row' box, row group box, 'table-column' box, or 'table-column-group' box.

tabular container

A 'table-row' box or proper table row parent

consecutive

Two sibling boxes are consecutive if they have no intervening siblings other than, optionally, an anonymous inline containing only white spaces. A sequence of sibling boxes is consecutive if each box in the sequence is consecutive to the one before it in the sequence.

For the purposes of these rules, out-of-flow elements are represented as inline elements of zero width and height. Their containing blocks are chosen accordingly.

The following steps are performed in three stages.

1. Remove irrelevant boxes:
 1. All child boxes of a 'table-column' parent are treated as if they had 'display: none'.
 2. If a child *C* of a 'table-column-group' parent is not a 'table-column' box, then it is treated as if it had 'display: none'.
 3. If a child *C* of a tabular container *P* is an anonymous inline box that contains only white space, and its immediately preceding and following siblings, if any, are proper table descendants of *P* and are either 'table-caption' or internal table boxes, then it is treated as if it had 'display: none'. A box *D* is a proper table descendant of *A* if *D* can be a descendant of *A* without causing the generation of any intervening 'table' or 'inline-table' boxes.
 4. If a box *B* is an anonymous inline containing only white space, and is

between two immediate siblings each of which is either an internal table box or a 'table-caption' box then *B* is treated as if it had 'display: none'.

2. Generate missing child wrappers:
 1. If a child *C* of a 'table' or 'inline-table' box is not a proper table child, then generate an anonymous 'table-row' box around *C* and all consecutive siblings of *C* that are not proper table children.
 2. If a child *C* of a row group box is not a 'table-row' box, then generate an anonymous 'table-row' box around *C* and all consecutive siblings of *C* that are not 'table-row' boxes.
 3. If a child *C* of a 'table-row' box is not a 'table-cell', then generate an anonymous 'table-cell' box around *C* and all consecutive siblings of *C* that are not 'table-cell' boxes.
3. Generate missing parents:
 1. For each 'table-cell' box *C* in a sequence of consecutive internal table and 'table-caption' siblings, if *C*'s parent is not a 'table-row' then generate an anonymous 'table-row' box around *C* and all consecutive siblings of *C* that are 'table-cell' boxes.
 2. For each proper table child *C* in a sequence of consecutive proper table children, if *C* is misparented then generate an anonymous 'table' or 'inline-table' box *T* around *C* and all consecutive siblings of *C* that are proper table children. (If *C*'s parent is an 'inline' box, then *T* must be an 'inline-table' box; otherwise it must be a 'table' box.)
 - A 'table-row' is misparented if its parent is neither a row group box nor a 'table' or 'inline-table' box.
 - A 'table-column' box is misparented if its parent is neither a 'table-column-group' box nor a 'table' or 'inline-table' box.
 - A row group box, 'table-column-group' box, or 'table-caption' box is misparented if its parent is neither a 'table' box nor an 'inline-table' box.

Example(s):

In this XML example, a 'table' element is assumed to contain the HBOX element:

```
<HBOX>
  <VBOX>George</VBOX>
  <VBOX>4287</VBOX>
  <VBOX>1998</VBOX>
</HBOX>
```

because the associated style sheet is:

```
HBOX { display: table-row }
VBOX { display: table-cell }
```

Example(s):

In this example, three 'table-cell' elements are assumed to contain the text in the ROWs. Note that the text is further encapsulated in anonymous inline boxes, as explained in visual formatting model [p. 132] :

```
<STACK>
  <ROW>This is the <D>top</D> row.</ROW>
  <ROW>This is the <D>middle</D> row.</ROW>
  <ROW>This is the <D>bottom</D> row.</ROW>
</STACK>
```

The style sheet is:

```
STACK { display: inline-table }
ROW   { display: table-row }
D     { display: inline; font-weight: bolder }
```

17.3 Columns

Table cells may belong to two contexts: rows and columns. However, in the source document cells are descendants of rows, never of columns. Nevertheless, some aspects of cells can be influenced by setting properties on columns.

The following properties apply to column and column-group elements:

'border'

The various border properties apply to columns only if 'border-collapse' is set to 'collapse' on the table element. In that case, borders set on columns and column groups are input to the conflict resolution algorithm [p. 292] that selects the border styles at every cell edge.

'background'

The background properties set the background for cells in the column, but only if both the cell and row have transparent backgrounds. See "Table layers and transparency." [p. 279]

'width'

The 'width' property gives the minimum width for the column.

'visibility'

If the 'visibility' of a column is set to 'collapse', none of the cells in the column are rendered, and cells that span into other columns are clipped. In addition, the width of the table is diminished by the width the column would have taken up. See "Dynamic effects" [p. 287] below. Other values for 'visibility' have no effect.

Example(s):

Here are some examples of style rules that set properties on columns. The first two rules together implement the "rules" attribute of HTML 4 with a value of "cols". The third rule makes the "totals" column blue, the final two rules shows how to make a column a fixed size, by using the fixed layout algorithm [p. 283] .

```
col { border-style: none solid }
table { border-style: hidden }
col.totals { background: blue }
table { table-layout: fixed }
col.totals { width: 5em }
```

17.4 Tables in the visual formatting model

In terms of the visual formatting model, a table can behave like a block-level [p. 129] (for 'display: table') or inline-level [p. 131] (for 'display: inline-table') element.

In both cases, the table generates a principal block box called the *table wrapper box* that contains the table box itself and any caption boxes (in document order). The *table box* is a block-level box that contains the table's internal table boxes. The caption boxes are block-level boxes that retain their own content, padding, margin, and border areas, and are rendered as normal block boxes inside the table wrapper box. Whether the caption boxes are placed before or after the table box is decided by the 'caption-side' property, as described below.

The table wrapper box is a 'block' box if the table is block-level, and an 'inline-block' box if the table is inline-level. The table wrapper box establishes a block formatting context. The table box (not the table wrapper box) is used when doing baseline vertical alignment for an 'inline-table'. The width of the table wrapper box is the border-edge width of the table box inside it, as described by section 17.5.2. Percentages on 'width' and 'height' on the table are relative to the table wrapper box's containing block, not the table wrapper box itself.

The computed values of properties 'position', 'float', 'margin-*', 'top', 'right', 'bottom', and 'left' on the table box are used on the table wrapper box instead of the table box. The table box uses the initial values for those properties.

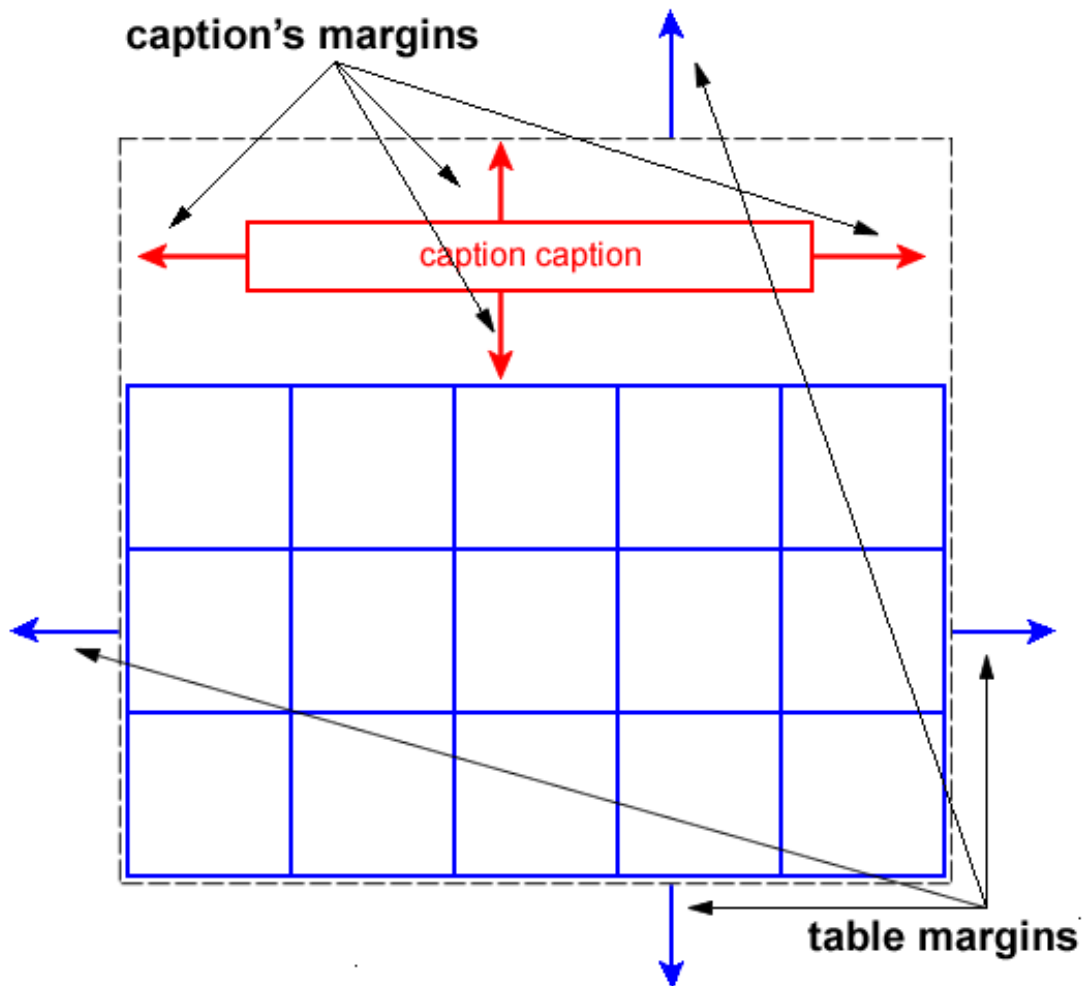

Diagram of a table with a caption above it.

17.4.1 Caption position and alignment

'caption-side'

Value: top | bottom | inherit
Initial: top
Applies to: 'table-caption' elements
Inherited: yes
Percentages: N/A
Media: visual
Computed value: as specified

This property specifies the position of the caption box with respect to the table box. Values have the following meanings:

top

Positions the caption box above the table box.

bottom

Positions the caption box below the table box.

Note: *CSS2 described a different width and horizontal alignment behavior. That behavior will be introduced in CSS3 using the values 'top-outside' and 'bottom-outside' on this property.*

To align caption content horizontally within the caption box, use the 'text-align' property.

Example(s):

In this example, the 'caption-side' property places captions below tables. The caption will be as wide as the parent of the table, and caption text will be left-justified.

```
caption { caption-side: bottom;
          width: auto;
          text-align: left }
```

17.5 Visual layout of table contents

Internal table elements generate rectangular boxes [p. 111] with content and borders. Cells have padding as well. Internal table elements do not have margins.

The visual layout of these boxes is governed by a rectangular, irregular grid of rows and columns. Each box occupies a whole number of grid cells, determined according to the following rules. These rules do not apply to HTML 4 or earlier HTML versions; HTML imposes its own limitations on row and column spans.

1. Each row box occupies one row of grid cells. Together, the row boxes fill the table from top to bottom in the order they occur in the source document (i.e., the table occupies exactly as many grid rows as there are row elements).
2. A row group occupies the same grid cells as the rows it contains.
3. A column box occupies one or more columns of grid cells. Column boxes are placed next to each other in the order they occur. The first column box may be either on the left or on the right, depending on the value of the 'direction' property of the table.
4. A column group box occupies the same grid cells as the columns it contains.
5. Cells may span several rows or columns. (Although CSS 2.1 does not define how the number of spanned rows or columns is determined, a user agent may have special knowledge about the source document; a future update of CSS may provide a way to express this knowledge in CSS syntax.) Each cell is thus a rectangular box, one or more grid cells wide and high. The top row of this rectangle is in the row specified by the cell's parent. The rectangle must be as far to the left as possible, but the part of the cell in the first column it occupies must not overlap with any other cell box (i.e., a row-spanning cell starting in a prior

row), and the cell must be to the right of all cells in the same row that are earlier in the source document. If this position would cause a column-spanning cell to overlap a row-spanning cell from a prior row, CSS does not define the results: implementations may either overlap the cells (as is done in many HTML implementations) or may shift the later cell to the right to avoid such overlap. (This constraint holds if the 'direction' property of the table is 'ltr'; if the 'direction' is 'rtl', interchange "left" and "right" in the previous two sentences.)

6. A cell box cannot extend beyond the last row box of a table or row group; the user agents must shorten it until it fits.

The edges of the rows, columns, row groups and column groups in the collapsing borders model [p. 291] coincide with the hypothetical grid lines on which the borders of the cells are centered. (And thus, in this model, the rows together exactly cover the table, leaving no gaps; ditto for the columns.) In the separated borders model, [p. 288] the edges coincide with the border edges [p. 112] of cells. (And thus, in this model, there may be gaps between the rows, columns, row groups or column groups, corresponding to the 'border-spacing' property.)

Note. *Positioning and floating of table cells can cause them not to be table cells anymore, according to the rules in section 9.7 [p. 154]. When floating is used, the rules on anonymous table objects may cause an anonymous cell object to be created as well.*

Here is an example illustrating rule 5. The following illegal (X)HTML snippet defines conflicting cells:

```
<table>
<tr><td>1 </td><td rowspan="2">2 </td><td>3 </td><td>4 </td></tr>
<tr><td colspan="2">5 </td></tr>
</table>
```

User agents are free to visually overlap the cells, as in the figure on the left, or to shift the cell to avoid the visual overlap, as in the figure on the right.



Two possible renderings of an erroneous HTML table.

17.5.1 Table layers and transparency

For the purposes of finding the background of each table cell, the different table elements may be thought of as being on six superimposed layers. The background set on an element in one of the layers will only be visible if the layers above it have a transparent background.

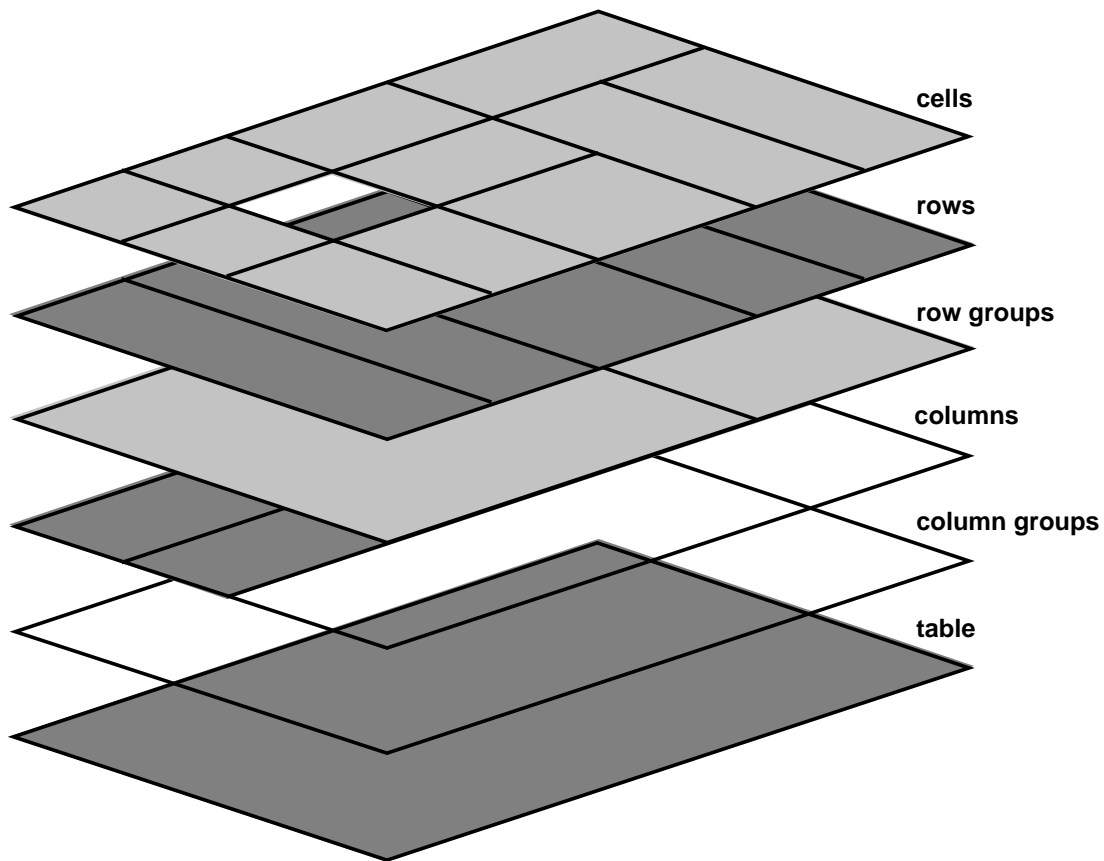

Schema of table layers.

1. The lowest layer is a single plane, representing the table box itself. Like all boxes, it may be transparent.
2. The next layer contains the column groups. Each column group extends from the top of the cells in the top row to the bottom of the cells on the bottom row and from the left edge of its leftmost column to the right edge of its rightmost column. The background covers exactly the full area of all cells that originate in the column group, even if they span outside the column group, but this difference in area does not affect background image positioning.
3. On top of the column groups are the areas representing the column boxes. Each column is as tall as the column groups and as wide as a normal (single-column-spanning) cell in the column. The background covers exactly the full area of all cells that originate in the column, even if they span outside the column, but this difference in area does not affect background image positioning.
4. Next is the layer containing the row groups. Each row group extends from the top left corner of its topmost cell in the first column to the bottom right corner of its bottommost cell in the last column.
5. The next to last layer contains the rows. Each row is as wide as the row groups and as tall as a normal (single-row-spanning) cell in the row. As with columns,

the background covers exactly the full area of all cells that originate in the row, even if they span outside the row, but this difference in area does not affect background image positioning.

- The topmost layer contains the cells themselves. As the figure shows, although all rows contain the same number of cells, not every cell may have specified content. In the separated borders model [p. 288] ('border-collapse' is 'separate'), if the value of their 'empty-cells' property is 'hide' these "empty" cells are transparent through the cell, row, row group, column and column group backgrounds, letting the table background show through.

A "missing cell" is a cell in the row/column grid that is not occupied by an element or pseudo-element. Missing cells are rendered as if an anonymous table-cell box occupied their position in the grid.

In the following example, the first row contains four non-empty cells, but the second row contains only one non-empty cell, and thus the table background shines through, except where a cell from the first row spans into this row. The following HTML code and style rules

```

<!DOCTYPE HTML PUBLIC "-//W3C//DTD HTML 4.01//EN">
<HTML>
  <HEAD>
    <TITLE>Table example</TITLE>
    <STYLE type="text/css">
      TABLE { background: #ff0; border: solid black;
              empty-cells: hide }
      TR.top { background: red }
      TD     { border: solid black }
    </STYLE>
  </HEAD>
  <BODY>
    <TABLE>
      <TR CLASS="top">
        <TD> 1
        <TD rowspan="2"> 2
        <TD> 3
        <TD> 4
      </TR>
      <TR>
        <TD> 5
        <TD>
      </TR>
    </TABLE>
  </BODY>
</HTML>

```

might be formatted as follows:

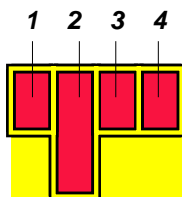

Table with empty cells in the bottom row.

Note that if the table has 'border-collapse: separate', the background of the area given by the 'border-spacing' property is always the background of the table element. See the separated borders model [p. 288] .

17.5.2 Table width algorithms: the 'table-layout' property

CSS does not define an "optimal" layout for tables since, in many cases, what is optimal is a matter of taste. CSS does define constraints that user agents must respect when laying out a table. User agents may use any algorithm they wish to do so, and are free to prefer rendering speed over precision, except when the "fixed layout algorithm" is selected.

Note that this section overrides the rules that apply to calculating widths as described in section 10.3 [p. 175] . In particular, if the margins of a table are set to '0' and the width to 'auto', the table will not automatically size to fill its containing block. However, once the calculated value of 'width' for the table is found (using the algorithms given below or, when appropriate, some other UA dependent algorithm) then the other parts of section 10.3 do apply. Therefore a table *can* be centered using left and right 'auto' margins, for instance.

Future updates of CSS may introduce ways of making tables automatically fit their containing blocks.

'table-layout'

<i>Value:</i>	auto fixed inherit
<i>Initial:</i>	auto
<i>Applies to:</i>	'table' and 'inline-table' elements
<i>Inherited:</i>	no
<i>Percentages:</i>	N/A
<i>Media:</i>	visual
<i>Computed value:</i>	as specified

The 'table-layout' property controls the algorithm used to lay out the table cells, rows, and columns. Values have the following meaning:

fixed

Use the fixed table layout algorithm

auto

Use any automatic table layout algorithm

The two algorithms are described below.

17.5.2.1 Fixed table layout

With this (fast) algorithm, the horizontal layout of the table does not depend on the contents of the cells; it only depends on the table's width, the width of the columns, and borders or cell spacing.

The table's width may be specified explicitly with the 'width' property. A value of 'auto' (for both 'display: table' and 'display: inline-table') means use the automatic table layout [p. 284] algorithm. However, if the table is a block-level table ('display: table') in normal flow, a UA may (but does not have to) use the algorithm of 10.3.3 [p. 176] to compute a width and apply fixed table layout even if the specified width is 'auto'.

Example(s):

If a UA supports fixed table layout when 'width' is 'auto', the following will create a table that is 4em narrower than its containing block:

```
table { table-layout: fixed;
        margin-left: 2em;
        margin-right: 2em }
```

In the fixed table layout algorithm, the width of each column is determined as follows:

1. A column element with a value other than 'auto' for the 'width' property sets the width for that column.
2. Otherwise, a cell in the first row with a value other than 'auto' for the 'width' property determines the width for that column. If the cell spans more than one column, the width is divided over the columns.
3. Any remaining columns equally divide the remaining horizontal table space (minus borders or cell spacing).

The width of the table is then the greater of the value of the 'width' property for the table element and the sum of the column widths (plus cell spacing or borders). If the table is wider than the columns, the extra space should be distributed over the columns.

If a subsequent row has more columns than the greater of the number determined by the table-column elements and the number determined by the first row, then additional columns may not be rendered. CSS 2.1 does not define the width of the columns and the table if they *are* rendered. When using 'table-layout: fixed', authors should not omit columns from the first row.

In this manner, the user agent can begin to lay out the table once the entire first row has been received. Cells in subsequent rows do not affect column widths. Any cell that has content that overflows uses the 'overflow' property to determine whether to clip the overflow content.

17.5.2.2 Automatic table layout

In this algorithm (which generally requires no more than two passes), the table's width is given by the width of its columns (and intervening borders [p. 288]). This algorithm reflects the behavior of several popular HTML user agents at the writing of this specification. UAs are not required to implement this algorithm to determine the table layout in the case that 'table-layout' is 'auto'; they can use any other algorithm even if it results in different behavior.

Input to the automatic table layout must only include the width of the containing block and the content of, and any CSS properties set on, the table and any of its descendants.

Note. *This may be defined in more detail in CSS3.*

The remainder of this section is non-normative.

This algorithm may be inefficient since it requires the user agent to have access to all the content in the table before determining the final layout and may demand more than one pass.

Column widths are determined as follows:

1. Calculate the minimum content width (MCW) of each cell: the formatted content may span any number of lines but may not overflow the cell box. If the specified 'width' (*W*) of the cell is greater than MCW, *W* is the minimum cell width. A value of 'auto' means that MCW is the minimum cell width.
 Also, calculate the "maximum" cell width of each cell: formatting the content without breaking lines other than where explicit line breaks occur.
2. For each column, determine a maximum and minimum column width from the cells that span only that column. The minimum is that required by the cell with the largest minimum cell width (or the column 'width', whichever is larger). The maximum is that required by the cell with the largest maximum cell width (or the column 'width', whichever is larger).
3. For each cell that spans more than one column, increase the minimum widths of the columns it spans so that together, they are at least as wide as the cell. Do the same for the maximum widths. If possible, widen all spanned columns by approximately the same amount.
4. For each column group element with a 'width' other than 'auto', increase the minimum widths of the columns it spans, so that together they are at least as wide as the column group's 'width'.

This gives a maximum and minimum width for each column.

The caption width minimum (CAPMIN) is determined by calculating for each caption the minimum caption outer width as the MCW of a hypothetical table cell that contains the caption formatted as "display: block". The greatest of the minimum caption outer widths is CAPMIN.

Column and caption widths influence the final table width as follows:

1. If the 'table' or 'inline-table' element's 'width' property has a computed value (W) other than 'auto', the used width is the greater of W , CAPMIN, and the minimum width required by all the columns plus cell spacing or borders (MIN). If the used width is greater than MIN, the extra width should be distributed over the columns.
2. If the 'table' or 'inline-table' element has 'width: auto', the used width is the greater of the table's containing block width, CAPMIN, and MIN. However, if either CAPMIN or the maximum width required by the columns plus cell spacing or borders (MAX) is less than that of the containing block, use $\max(\text{MAX}, \text{CAPMIN})$.

A percentage value for a column width is relative to the table width. If the table has 'width: auto', a percentage represents a constraint on the column's width, which a UA should try to satisfy. (Obviously, this is not always possible: if the column's width is '110%', the constraint cannot be satisfied.)

Note. *In this algorithm, rows (and row groups) and columns (and column groups) both constrain and are constrained by the dimensions of the cells they contain. Setting the width of a column may indirectly influence the height of a row, and vice versa.*

17.5.3 Table height algorithms

The height of a table is given by the 'height' property for the 'table' or 'inline-table' element. A value of 'auto' means that the height is the sum of the row heights plus any cell spacing or borders. Any other value is treated as a minimum height. CSS 2.1 does not define how extra space is distributed when the 'height' property causes the table to be taller than it otherwise would be. **Note.** Future updates of CSS may specify this further.

The height of a 'table-row' element's box is calculated once the user agent has all the cells in the row available: it is the maximum of the row's computed 'height', the computed 'height' of each cell in the row, and the minimum height (MIN) required by the cells. A 'height' value of 'auto' for a 'table-row' means the row height used for layout is MIN. MIN depends on cell box heights and cell box alignment (much like the calculation of a line box [p. 190] height). CSS 2.1 does not define how the height of table cells and table rows is calculated when their height is specified using percentage values. CSS 2.1 does not define the meaning of 'height' on row groups.

In CSS 2.1, the height of a cell box is the minimum height required by the content. The table cell's 'height' property can influence the height of the row (see above), but it does not increase the height of the cell box.

CSS 2.1 does not specify how cells that span more than one row affect row height calculations except that the sum of the row heights involved must be great enough to encompass the cell spanning the rows.

The 'vertical-align' property of each table cell determines its alignment within the row. Each cell's content has a baseline, a top, a middle, and a bottom, as does the row itself. In the context of tables, values for 'vertical-align' have the following meanings:

baseline

The baseline of the cell is put at the same height as the baseline of the first of the rows it spans (see below for the definition of baselines of cells and rows).

top

The top of the cell box is aligned with the top of the first row it spans.

bottom

The bottom of the cell box is aligned with the bottom of the last row it spans.

middle

The center of the cell is aligned with the center of the rows it spans.

sub, super, text-top, text-bottom, <length>, <percentage>

These values do not apply to cells; the cell is aligned at the baseline instead.

The baseline of a cell is the baseline of the first in-flow line box [p. 139] in the cell, or the first in-flow table-row in the cell, whichever comes first. If there is no such line box or table-row, the baseline is the bottom of content edge of the cell box. For the purposes of finding a baseline, in-flow boxes with a scrolling mechanisms (see the 'overflow' property) must be considered as if scrolled to their origin position. Note that the baseline of a cell may end up below its bottom border, see the example [p. 287] below.

The maximum distance between the top of the cell box and the baseline over all cells that have 'vertical-align: baseline' is used to set the baseline of the row. Here is an example:

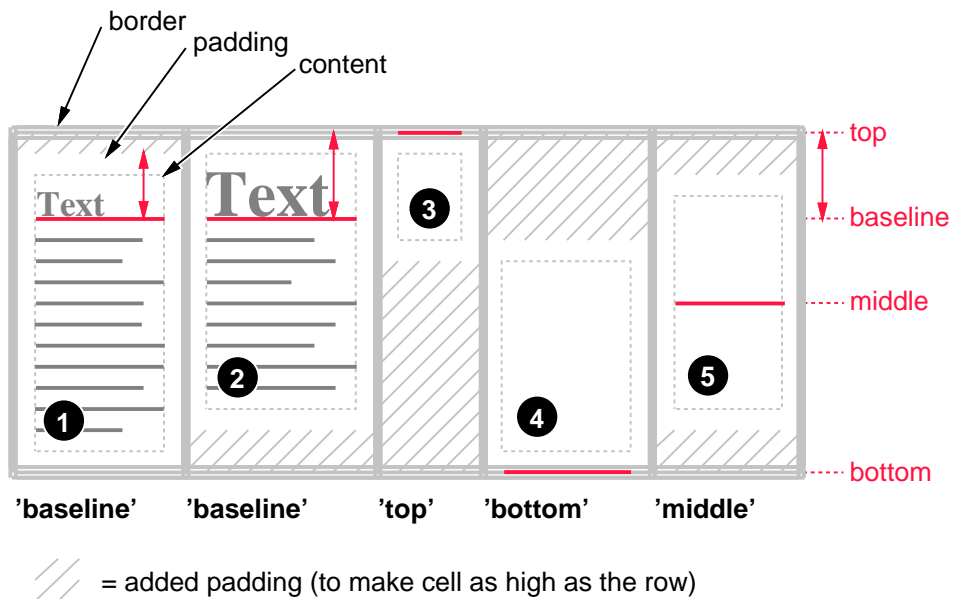

Diagram showing the effect of various values of 'vertical-align' on table cells.

Cell boxes 1 and 2 are aligned at their baselines. Cell box 2 has the largest height above the baseline, so that determines the baseline of the row.

If a row has no cell box aligned to its baseline, the baseline of that row is the bottom content edge of the lowest cell in the row.

To avoid ambiguous situations, the alignment of cells proceeds in the following order:

1. First the cells that are aligned on their baseline are positioned. This will establish the baseline of the row. Next the cells with 'vertical-align: top' are positioned.
2. The row now has a top, possibly a baseline, and a provisional height, which is the distance from the top to the lowest bottom of the cells positioned so far. (See conditions on the cell padding below.)
3. If any of the remaining cells, those aligned at the bottom or the middle, have a height that is larger than the current height of the row, the height of the row will be increased to the maximum of those cells, by lowering the bottom.
4. Finally the remaining cells are positioned.

Cell boxes that are smaller than the height of the row receive extra top or bottom padding.

The cell in this example has a baseline below its bottom border:

```
div { height: 0; overflow: hidden; }

<table>
  <tr>
    <td>
      <div> Test </div>
    </td>
  </tr>
</table>
```

17.5.4 Horizontal alignment in a column

The horizontal alignment of a cell's inline content within a cell box can be specified by the value of the 'text-align' property on the cell.

17.5.5 Dynamic row and column effects

The 'visibility' property takes the value 'collapse' for row, row group, column, and column group elements. This value causes the entire row or column to be removed from the display, and the space normally taken up by the row or column to be made available for other content. Contents of spanned rows and columns that intersect the collapsed column or row are clipped. The suppression of the row or column, however, does not otherwise affect the layout of the table. This allows dynamic effects to remove table rows or columns without forcing a re-layout of the table in

order to account for the potential change in column constraints.

17.6 Borders

There are two distinct models for setting borders on table cells in CSS. One is most suitable for so-called separated borders around individual cells, the other is suitable for borders that are continuous from one end of the table to the other. Many border styles can be achieved with either model, so it is often a matter of taste which one is used.

'border-collapse'

<i>Value:</i>	collapse separate inherit
<i>Initial:</i>	separate
<i>Applies to:</i>	'table' and 'inline-table' elements
<i>Inherited:</i>	yes
<i>Percentages:</i>	N/A
<i>Media:</i>	visual
<i>Computed value:</i>	as specified

This property selects a table's border model. The value 'separate' selects the separated borders border model. The value 'collapse' selects the collapsing borders model. The models are described below.

17.6.1 The separated borders model

'border-spacing'

<i>Value:</i>	<length> <length>? inherit
<i>Initial:</i>	0
<i>Applies to:</i>	'table' and 'inline-table' elements*
<i>Inherited:</i>	yes
<i>Percentages:</i>	N/A
<i>Media:</i>	visual
<i>Computed value:</i>	two absolute lengths

*) Note: user agents may also apply the 'border-spacing' property to 'frameset' elements. Which elements are 'frameset' elements is not defined by this specification and is up to the document language. For example, HTML4 defines a <FRAMESET> element, and XHTML 1.0 defines a <frameset> element. The 'border-spacing' property on a 'frameset' element can be thus used as a valid substitute for the non-standard 'framespacing' attribute.

The lengths specify the distance that separates adjoining cell borders. If one length is specified, it gives both the horizontal and vertical spacing. If two are specified, the first gives the horizontal spacing and the second the vertical spacing.

Lengths may not be negative.

The distance between the table border and the borders of the cells on the edge of the table is the table's padding for that side, plus the relevant border spacing distance. For example, on the right hand side, the distance is *padding-right + horizontal border-spacing*.

The width of the table is the distance from the left inner padding edge to the right inner padding edge (including the border spacing but excluding padding and border).

However, in HTML and XHTML1, the width of the <table> element is the distance from the left border edge to the right border edge.

Note: In CSS3 this peculiar requirement will be defined in terms of UA style sheet rules and the 'box-sizing' property.

In this model, each cell has an individual border. The 'border-spacing' property specifies the distance between the borders of adjoining cells. In this space, the row, column, row group, and column group backgrounds are invisible, allowing the table background to show through. Rows, columns, row groups, and column groups cannot have borders (i.e., user agents must ignore [p. 60] the border properties for those elements).

Example(s):

The table in the figure below could be the result of a style sheet like this:

```
table      { border: outset 10pt;
             border-collapse: separate;
             border-spacing: 15pt }
td        { border: inset 5pt }
td.special { border: inset 10pt } /* The top-left cell */
```

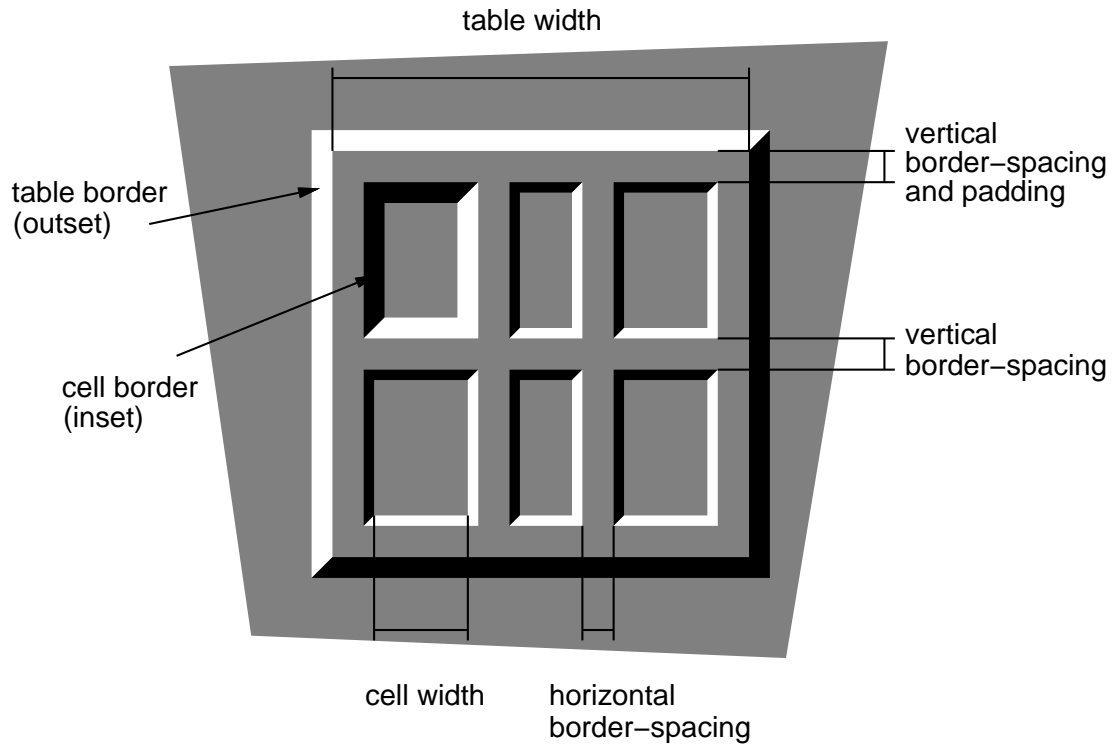

A table with 'border-spacing' set to a length value. Note that each cell has its own border, and the table has a separate border as well.

17.6.1.1 Borders and Backgrounds around empty cells: the 'empty-cells' property

'empty-cells'

<i>Value:</i>	show hide inherit
<i>Initial:</i>	show
<i>Applies to:</i>	'table-cell' elements
<i>Inherited:</i>	yes
<i>Percentages:</i>	N/A
<i>Media:</i>	visual
<i>Computed value:</i>	as specified

In the separated borders model, this property controls the rendering of borders and backgrounds around cells that have no visible content. Empty cells and cells with the 'visibility' property set to 'hidden' are considered to have no visible content. Cells are empty unless they contain one or more of the following:

- floating content (including empty elements),
- in-flow content (including empty elements) other than white space that has been collapsed away by the 'white-space' property handling.

When this property has the value 'show', borders and backgrounds are drawn around/behind empty cells (like normal cells).

A value of 'hide' means that no borders or backgrounds are drawn around/behind empty cells (see point 6 in 17.5.1 [p. 279]). Furthermore, if all the cells in a row have a value of 'hide' and have no visible content, then the row has zero height and there is vertical border-spacing on only one side of the row.

Example(s):

The following rule causes borders and backgrounds to be drawn around all cells:

```
table { empty-cells: show }
```

17.6.2 The collapsing border model

In the collapsing border model, it is possible to specify borders that surround all or part of a cell, row, row group, column, and column group. Borders for HTML's "rule" attribute can be specified this way.

Borders are centered on the grid lines between the cells. User agents must find a consistent rule for rounding off in the case of an odd number of discrete units (screen pixels, printer dots).

The diagram below shows how the width of the table, the widths of the borders, the padding, and the cell width interact. Their relation is given by the following equation, which holds for every row of the table:

$$\text{row-width} = (0.5 * \text{border-width}_0) + \text{padding-left}_1 + \text{width}_1 + \text{padding-right}_1 + \text{border-width}_1 + \text{padding-left}_2 + \dots + \text{padding-right}_n + (0.5 * \text{border-width}_n)$$

Here n is the number of cells in the row, padding-left_i and padding-right_i refer to the left (resp., right) padding of cell i , and border-width_i refers to the border between cells i and $i + 1$.

UAs must compute an initial left and right border width for the table by examining the first and last cells in the first row of the table. The left border width of the table is half of the first cell's collapsed left border, and the right border width of the table is half of the last cell's collapsed right border. If subsequent rows have larger collapsed left and right borders, then any excess spills into the margin area of the table.

The top border width of the table is computed by examining all cells who collapse their top borders with the top border of the table. The top border width of the table is equal to half of the maximum collapsed top border. The bottom border width is computed by examining all cells whose bottom borders collapse with the bottom of the table. The bottom border width is equal to half of the maximum collapsed bottom border.

Any borders that spill into the margin are taken into account when determining if the table overflows some ancestor (see 'overflow').

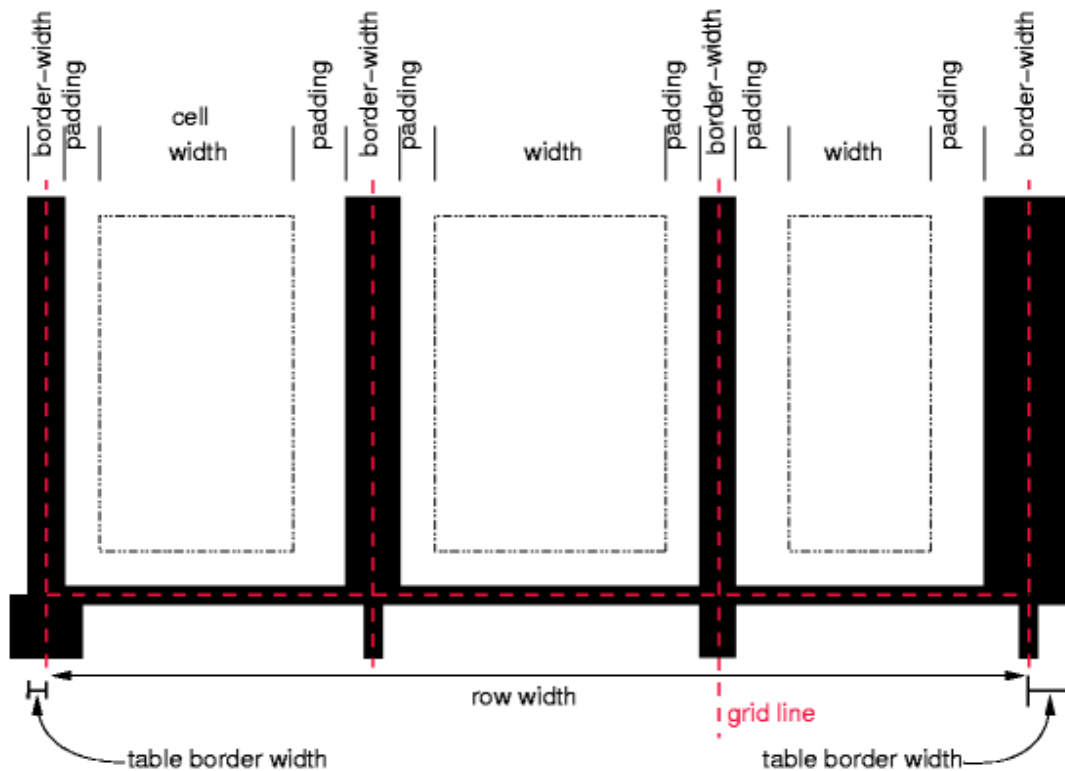

Schema showing the widths of cells and borders and the padding of cells.

Note that in this model, the width of the table includes half the table border. Also, in this model, a table does not have padding (but does have margins).

CSS 2.1 does not define where the edge of a background on a table element lies.

17.6.2.1 Border conflict resolution

In the collapsing border model, borders at every edge of every cell may be specified by border properties on a variety of elements that meet at that edge (cells, rows, row groups, columns, column groups, and the table itself), and these borders may vary in width, style, and color. The rule of thumb is that at each edge the most "eye catching" border style is chosen, except that any occurrence of the style 'hidden' unconditionally turns the border off.

The following rules determine which border style "wins" in case of a conflict:

1. Borders with the 'border-style' of 'hidden' take precedence over all other conflicting borders. Any border with this value suppresses all borders at this location.
2. Borders with a style of 'none' have the lowest priority. Only if the border properties of all the elements meeting at this edge are 'none' will the border be omitted (but note that 'none' is the default value for the border style.)
3. If none of the styles are 'hidden' and at least one of them is not 'none', then narrow borders are discarded in favor of wider ones. If several have the same 'border-width' then styles are preferred in this order: 'double', 'solid', 'dashed',

'dotted', 'ridge', 'outset', 'groove', and the lowest: 'inset'.

4. If border styles differ only in color, then a style set on a cell wins over one on a row, which wins over a row group, column, column group and, lastly, table.

When two elements of the same type conflict, then the one further to the left (if the table's 'direction' is 'ltr'; right, if it is 'rtl') and further to the top wins.

Example(s):

The following example illustrates the application of these precedence rules. This style sheet:

```
table          { border-collapse: collapse;
                 border: 5px solid yellow; }
#col1         { border: 3px solid black; }
td            { border: 1px solid red; padding: 1em; }
td.cell5     { border: 5px dashed blue; }
td.cell6     { border: 5px solid green; }
```

with this HTML source:

```
<TABLE>
<COL id="col1"><COL id="col2"><COL id="col3">
<TR id="row1">
  <TD> 1
  <TD> 2
  <TD> 3
</TR>
<TR id="row2">
  <TD> 4
  <TD class="cell5"> 5
  <TD class="cell6"> 6
</TR>
<TR id="row3">
  <TD> 7
  <TD> 8
  <TD> 9
</TR>
<TR id="row4">
  <TD> 10
  <TD> 11
  <TD> 12
</TR>
<TR id="row5">
  <TD> 13
  <TD> 14
  <TD> 15
</TR>
</TABLE>
```

would produce something like this:

1	2	3
4	5	6
7	8	9
10	11	12
13	14	15

An example of a table with collapsed borders.

Example(s):

Here is an example of hidden collapsing borders:

foo	bar
foo	bar

Table with two omitted internal borders.

HTML source:

```
<TABLE style="border-collapse: collapse; border: solid;">
<TR><TD style="border-right: hidden; border-bottom: hidden">foo</TD>
  <TD style="border: solid">bar</TD></TR>
<TR><TD style="border: none">foo</TD>
  <TD style="border: solid">bar</TD></TR>
</TABLE>
```

17.6.3 Border styles

Some of the values of the 'border-style' have different meanings in tables than for other elements. In the list below they are marked with an asterisk.

none

No border.

***hidden**

Same as 'none', but in the collapsing border model [p. 291] , also inhibits any other border (see the section on border conflicts [p. 292]).

dotted

The border is a series of dots.

dashed

The border is a series of short line segments.

solid

The border is a single line segment.

double

The border is two solid lines. The sum of the two lines and the space between them equals the value of 'border-width'.

groove

The border looks as though it were carved into the canvas.

ridge

The opposite of 'groove': the border looks as though it were coming out of the canvas.

***inset**

In the separated borders model [p. 288] , the border makes the entire box look as though it were embedded in the canvas. In the collapsing border model [p. 291] , same as 'ridge'.

***outset**

In the separated borders model [p. 288] , the border makes the entire box look as though it were coming out of the canvas. In the collapsing border model [p. 291] , same as 'groove'.

Tables

18 User interface

Contents

18.1 Cursors: the 'cursor' property	297
18.2 System Colors	298
18.3 User preferences for fonts	300
18.4 Dynamic outlines: the 'outline' property	300
18.4.1 Outlines and the focus	302
18.5 Magnification	303

18.1 Cursors: the 'cursor' property

'cursor'

<i>Value:</i>	[[<uri> ,]* [auto crosshair default pointer move e-resize ne-resize nw-resize n-resize se-resize sw-resize s-resize w-resize text wait help progress]] inherit
<i>Initial:</i>	auto
<i>Applies to:</i>	all elements
<i>Inherited:</i>	yes
<i>Percentages:</i>	N/A
<i>Media:</i>	visual, interactive
<i>Computed value:</i>	as specified, except with any relative URLs converted to absolute

This property specifies the type of cursor to be displayed for the pointing device. Values have the following meanings:

auto

The UA determines the cursor to display based on the current context.

crosshair

A simple crosshair (e.g., short line segments resembling a "+" sign).

default

The platform-dependent default cursor. Often rendered as an arrow.

pointer

The cursor is a pointer that indicates a link.

move

Indicates something is to be moved.

e-resize, ne-resize, nw-resize, n-resize, se-resize, sw-resize, s-resize, w-resize

Indicate that some edge is to be moved. For example, the 'se-resize' cursor is used when the movement starts from the south-east corner of the box.

text

Indicates text that may be selected. Often rendered as an I-beam.

wait

Indicates that the program is busy and the user should wait. Often rendered as a watch or hourglass.

progress

A progress indicator. The program is performing some processing, but is different from 'wait' in that the user may still interact with the program. Often rendered as a spinning beach ball, or an arrow with a watch or hourglass.

help

Help is available for the object under the cursor. Often rendered as a question mark or a balloon.

<uri>

The user agent retrieves the cursor from the resource designated by the URI. If the user agent cannot handle the first cursor of a list of cursors, it should attempt to handle the second, etc. If the user agent cannot handle any user-defined cursor, it must use the generic cursor at the end of the list. Intrinsic sizes for cursors are calculated as for background images, [p. 232] except that a UA-defined rectangle is used in place of the rectangle that establishes the coordinate system for the 'background-image' property. This UA-defined rectangle should be based on the size of a typical cursor on the UA's operating system. If the resulting cursor size does not fit within this rectangle, the UA may proportionally scale the resulting cursor down until it fits within the rectangle.

Example(s):

```
:link,:visited { cursor: url(example.svg#linkcursor), url(hyper.cur), pointer }
```

This example sets the cursor on all hyperlinks (whether visited or not) to an external SVG cursor [p. ??]. User agents that do not support SVG cursors would simply skip to the next value and attempt to use the "hyper.cur" cursor. If that cursor format was also not supported, the UA would skip to the next value and simply render the 'pointer' cursor.

18.2 System Colors

Note. *The System Colors are deprecated in the CSS3 Color Module [CSS3COLOR].*

In addition to being able to assign pre-defined color values [p. 68] to text, backgrounds, etc., CSS2 introduced a set of named color values that allows authors to specify colors in a manner that integrates them into the operating system's graphic environment.

For systems that do not have a corresponding value, the specified value should be mapped to the nearest system value, or to a default color.

The following lists additional values for color-related CSS properties and their general meaning. Any color property (e.g., 'color' or 'background-color') can take one of the following names. Although these are case-insensitive, it is recommended that

the mixed capitalization shown below be used, to make the names more legible.

ActiveBorder

Active window border.

ActiveCaption

Active window caption.

AppWorkspace

Background color of multiple document interface.

Background

Desktop background.

ButtonFace

Face color for three-dimensional display elements.

ButtonHighlight

Highlight color for three-dimensional display elements (for edges facing away from the light source).

ButtonShadow

Shadow color for three-dimensional display elements.

ButtonText

Text on push buttons.

CaptionText

Text in caption, size box, and scrollbar arrow box.

GrayText

Grayed (disabled) text. This color is set to #000 if the current display driver does not support a solid gray color.

Highlight

Item(s) selected in a control.

HighlightText

Text of item(s) selected in a control.

InactiveBorder

Inactive window border.

InactiveCaption

Inactive window caption.

InactiveCaptionText

Color of text in an inactive caption.

InfoBackground

Background color for tooltip controls.

InfoText

Text color for tooltip controls.

Menu

Menu background.

MenuText

Text in menus.

Scrollbar

Scroll bar gray area.

ThreeDDarkShadow

Dark shadow for three-dimensional display elements.

ThreeDFace

Face color for three-dimensional display elements.

ThreeDHighlight

Highlight color for three-dimensional display elements.

ThreeDLightShadow

Light color for three-dimensional display elements (for edges facing the light source).

ThreeDShadow

Dark shadow for three-dimensional display elements.

Window

Window background.

WindowFrame

Window frame.

WindowText

Text in windows.

Example(s):

For example, to set the foreground and background colors of a paragraph to the same foreground and background colors of the user's window, write the following:

```
p { color: WindowText; background-color: Window }
```

18.3 User preferences for fonts

As for colors, authors may specify fonts in a way that makes use of a user's system resources. Please consult the 'font' property for details.

18.4 Dynamic outlines: the 'outline' property

At times, style sheet authors may want to create outlines around visual objects such as buttons, active form fields, image maps, etc., to make them stand out. CSS 2.1 outlines differ from borders [p. 120] in the following ways:

1. Outlines do not take up space.
2. Outlines may be non-rectangular.

The outline properties control the style of these dynamic outlines.

'outline'

Value: [<'outline-color'> || <'outline-style'> || <'outline-width'>] | inherit
Initial: see individual properties
Applies to: all elements
Inherited: no
Percentages: N/A
Media: visual, interactive
Computed value: see individual properties

'outline-width'

Value: <border-width> | inherit
Initial: medium
Applies to: all elements
Inherited: no
Percentages: N/A
Media: visual, interactive
Computed value: absolute length; '0' if the outline style is 'none'

'outline-style'

Value: <border-style> | inherit
Initial: none
Applies to: all elements
Inherited: no
Percentages: N/A
Media: visual, interactive
Computed value: as specified

'outline-color'

Value: <color> | invert | inherit
Initial: invert
Applies to: all elements
Inherited: no
Percentages: N/A
Media: visual, interactive
Computed value: as specified

The outline created with the outline properties is drawn "over" a box, i.e., the outline is always on top, and does not influence the position or size of the box, or of any other boxes. Therefore, displaying or suppressing outlines does not cause reflow or overflow.

The outline may be drawn starting just outside the border edge [p. 112] .

Outlines may be non-rectangular. For example, if the element is broken across several lines, the outline is the minimum outline that encloses all the element's boxes. In contrast to borders [p. 120] , the outline is not open at the line box's end or start, but is always fully connected if possible.

The 'outline-width' property accepts the same values as 'border-width'.

The 'outline-style' property accepts the same values as 'border-style', except that 'hidden' is not a legal outline style.

The 'outline-color' accepts all colors, as well as the keyword 'invert'. 'Invert' is expected to perform a color inversion on the pixels on the screen. This is a common trick to ensure the focus border is visible, regardless of color background.

Conformant UAs may ignore the 'invert' value on platforms that do not support color inversion of the pixels on the screen. If the UA does not support the 'invert' value then the initial value of the 'outline-color' property is the value of the 'color' property, similar to the initial value of the 'border-top-color' property.

The 'outline' property is a shorthand property, and sets all three of 'outline-style', 'outline-width', and 'outline-color'.

Note. *The outline is the same on all sides. In contrast to borders, there is no 'outline-top' or 'outline-left' property.*

This specification does not define how multiple overlapping outlines are drawn, or how outlines are drawn for boxes that are partially obscured behind other elements.

Note. *Since the outline does not affect formatting (i.e., no space is left for it in the box model), it may well overlap other elements on the page.*

Example(s):

Here's an example of drawing a thick outline around a BUTTON element:

```
button { outline : thick solid}
```

Scripts may be used to dynamically change the width of the outline, without provoking a reflow.

18.4.1 Outlines and the focus

Graphical user interfaces may use outlines around elements to tell the user which element on the page has the *focus*. These outlines are in addition to any borders, and switching outlines on and off should not cause the document to reflow. The focus is the subject of user interaction in a document (e.g., for entering text, selecting a button, etc.). User agents supporting the interactive media group [p. 110] must keep track of where the focus lies and must also represent the focus. This may be done by using dynamic outlines in conjunction with the `:focus` pseudo-class.

Example(s):

For example, to draw a thick black line around an element when it has the focus, and a thick red line when it is active, the following rules can be used:

```
:focus { outline: thick solid black }  
:active { outline: thick solid red }
```

18.5 Magnification

The CSS working group considers that the magnification of a document or portions of a document should not be specified through style sheets. User agents may support such magnification in different ways (e.g., larger images, louder sounds, etc.)

When magnifying a page, UAs should preserve the relationships between positioned elements. For example, a comic strip may be composed of images with overlaid text elements. When magnifying this page, a user agent should keep the text within the comic strip balloon.

Appendix A. Aural style sheets

Contents

A.1 The media types 'aural' and 'speech'	305
A.2 Introduction to aural style sheets	306
A.2.1 Angles	307
A.2.2 Times	307
A.2.3 Frequencies	307
A.3 Volume properties: 'volume'	308
A.4 Speaking properties: 'speak'	309
A.5 Pause properties: 'pause-before', 'pause-after', and 'pause'	310
A.6 Cue properties: 'cue-before', 'cue-after', and 'cue'	311
A.7 Mixing properties: 'play-during'	312
A.8 Spatial properties: 'azimuth' and 'elevation'	313
A.9 Voice characteristic properties: 'speech-rate', 'voice-family', 'pitch', 'pitch-range', 'stress', and 'richness'	316
A.10 Speech properties: 'speak-punctuation' and 'speak-numeral'	319
A.11 Audio rendering of tables	320
A.11.1 Speaking headers: the 'speak-header' property	321
A.12 Sample style sheet for HTML	323
A.13 Emacspeak	324

This chapter is informative. UAs are not required to implement the properties of this chapter in order to conform to CSS 2.1.

A.1 The media types 'aural' and 'speech'

We expect that in a future level of CSS there will be new properties and values defined for speech output. Therefore CSS 2.1 reserves the 'speech' media type (see chapter 7, "Media types" [p. 107]), but does not yet define which properties do or do not apply to it.

The properties in this appendix apply to a media type 'aural', that was introduced in CSS2. The type 'aural' is now deprecated.

This means that a style sheet such as

```
@media speech {
  body { voice-family: Paul }
}
```

is valid, but that its meaning is not defined by CSS 2.1, while

```
@media aural {
  body { voice-family: Paul }
}
```

is deprecated, but defined by this appendix.

A.2 Introduction to aural style sheets

The aural rendering of a document, already commonly used by the blind and print-impaired communities, combines speech synthesis and "auditory icons." Often such aural presentation occurs by converting the document to plain text and feeding this to a *screen reader* -- software or hardware that simply reads all the characters on the screen. This results in less effective presentation than would be the case if the document structure were retained. Style sheet properties for aural presentation may be used together with visual properties (mixed media) or as an aural alternative to visual presentation.

Besides the obvious accessibility advantages, there are other large markets for listening to information, including in-car use, industrial and medical documentation systems (intranets), home entertainment, and to help users learning to read or who have difficulty reading.

When using aural properties, the canvas consists of a three-dimensional physical space (sound surrounds) and a temporal space (one may specify sounds before, during, and after other sounds). The CSS properties also allow authors to vary the quality of synthesized speech (voice type, frequency, inflection, etc.).

Example(s):

```
h1, h2, h3, h4, h5, h6 {
  voice-family: paul;
  stress: 20;
  richness: 90;
  cue-before: url("ping.au")
}
p.heidi { azimuth: center-left }
p.peter { azimuth: right }
p.goat { volume: x-soft }
```

This will direct the speech synthesizer to speak headers in a voice (a kind of "audio font") called "paul", on a flat tone, but in a very rich voice. Before speaking the headers, a sound sample will be played from the given URL. Paragraphs with class "heidi" will appear to come from front left (if the sound system is capable of spatial audio), and paragraphs of class "peter" from the right. Paragraphs with class "goat" will be very soft.

A.2.1 Angles

Angle values are denoted by `<angle>` in the text. Their format is a `<number>` immediately followed by an angle unit identifier.

Angle unit identifiers are:

- **deg**: degrees
- **grad**: grads
- **rad**: radians

Angle values may be negative. They should be normalized to the range 0-360deg by the user agent. For example, -10deg and 350deg are equivalent.

For example, a right angle is '90deg' or '100grad' or '1.570796326794897rad'.

Like for `<length>`, the unit may be omitted, if the value is zero: '0deg' may be written as '0'.

A.2.2 Times

Time values are denoted by `<time>` in the text. Their format is a `<number>` immediately followed by a time unit identifier.

Time unit identifiers are:

- **ms**: milliseconds
- **s**: seconds

Time values may not be negative.

Like for `<length>`, the unit may be omitted, if the value is zero: '0s' may be written as '0'.

A.2.3 Frequencies

Frequency values are denoted by `<frequency>` in the text. Their format is a `<number>` immediately followed by a frequency unit identifier.

Frequency unit identifiers are:

- **Hz**: Hertz
- **kHz**: kilohertz

Frequency values may not be negative.

For example, 200Hz (or 200hz) is a bass sound, and 6kHz is a treble sound.

Like for `<length>`, the unit may be omitted, if the value is zero: '0Hz' may be written as '0'.

A.3 Volume properties: 'volume'

'volume'

<i>Value:</i>	<number> <percentage> silent x-soft soft medium loud x-loud inherit
<i>Initial:</i>	medium
<i>Applies to:</i>	all elements
<i>Inherited:</i>	yes
<i>Percentages:</i>	refer to inherited value
<i>Media:</i>	aural
<i>Computed value:</i>	number

Volume refers to the median volume of the waveform. In other words, a highly inflected voice at a volume of 50 might peak well above that. The overall values are likely to be human adjustable for comfort, for example with a physical volume control (which would increase both the 0 and 100 values proportionately); what this property does is adjust the dynamic range.

Values have the following meanings:

<number>

Any number between '0' and '100'. '0' represents the *minimum audible* volume level and 100 corresponds to the *maximum comfortable* level.

<percentage>

Percentage values are calculated relative to the inherited value, and are then clipped to the range '0' to '100'.

silent

No sound at all. The value '0' does not mean the same as 'silent'.

x-soft

Same as '0'.

soft

Same as '25'.

medium

Same as '50'.

loud

Same as '75'.

x-loud

Same as '100'.

User agents should allow the values corresponding to '0' and '100' to be set by the listener. No one setting is universally applicable; suitable values depend on the equipment in use (speakers, headphones), the environment (in car, home theater, library) and personal preferences. Some examples:

- A browser for in-car use has a setting for when there is lots of background noise. '0' would map to a fairly high level and '100' to a quite high level. The speech is easily audible over the road noise but the overall dynamic range is compressed. Cars with better insulation might allow a wider dynamic range.
- Another speech browser is being used in an apartment, late at night, or in a shared study room. '0' is set to a very quiet level and '100' to a fairly quiet level, too. As with the first example, there is a low slope; the dynamic range is reduced. The actual volumes are low here, whereas they were high in the first example.
- In a quiet and isolated house, an expensive hi-fi home theater setup. '0' is set fairly low and '100' to quite high; there is wide dynamic range.

The same author style sheet could be used in all cases, simply by mapping the '0' and '100' points suitably at the client side.

A.4 Speaking properties: 'speak'

'speak'

<i>Value:</i>	normal none spell-out inherit
<i>Initial:</i>	normal
<i>Applies to:</i>	all elements
<i>Inherited:</i>	yes
<i>Percentages:</i>	N/A
<i>Media:</i>	aural
<i>Computed value:</i>	as specified

This property specifies whether text will be rendered aurally and if so, in what manner. The possible values are:

none

Suppresses aural rendering so that the element requires no time to render. Note, however, that descendants may override this value and will be spoken. (To be sure to suppress rendering of an element and its descendants, use the 'display' property).

normal

Uses language-dependent pronunciation rules for rendering an element and its children.

spell-out

Spells the text one letter at a time (useful for acronyms and abbreviations).

Note the difference between an element whose 'volume' property has a value of 'silent' and an element whose 'speak' property has the value 'none'. The former takes up the same time as if it had been spoken, including any pause before and after the element, but no sound is generated. The latter requires no time and is not rendered (though its descendants may be).

A.5 Pause properties: 'pause-before', 'pause-after', and 'pause'

'pause-before'

<i>Value:</i>	<time> <percentage> inherit
<i>Initial:</i>	0
<i>Applies to:</i>	all elements
<i>Inherited:</i>	no
<i>Percentages:</i>	see prose
<i>Media:</i>	aural
<i>Computed value:</i>	time

'pause-after'

<i>Value:</i>	<time> <percentage> inherit
<i>Initial:</i>	0
<i>Applies to:</i>	all elements
<i>Inherited:</i>	no
<i>Percentages:</i>	see prose
<i>Media:</i>	aural
<i>Computed value:</i>	time;;

These properties specify a pause to be observed before (or after) speaking an element's content. Values have the following meanings:

Note. In CSS3 pauses are inserted around the cues and content rather than between them. See [CSS3SPEECH] for details.

<time>

Expresses the pause in absolute time units (seconds and milliseconds).

<percentage>

Refers to the inverse of the value of the 'speech-rate' property. For example, if the speech-rate is 120 words per minute (i.e., a word takes half a second, or 500ms) then a 'pause-before' of 100% means a pause of 500 ms and a 'pause-before' of 20% means 100ms.

The pause is inserted between the element's content and any 'cue-before' or 'cue-after' content.

Authors should use relative units to create more robust style sheets in the face of large changes in speech-rate.

'pause'

<i>Value:</i>	[[<time> <percentage>]{1,2}] inherit
<i>Initial:</i>	see individual properties
<i>Applies to:</i>	all elements
<i>Inherited:</i>	no
<i>Percentages:</i>	see descriptions of 'pause-before' and 'pause-after'
<i>Media:</i>	aural
<i>Computed value:</i>	see individual properties

The 'pause' property is a shorthand for setting 'pause-before' and 'pause-after'. If two values are given, the first value is 'pause-before' and the second is 'pause-after'. If only one value is given, it applies to both properties.

Example(s):

```
h1 { pause: 20ms } /* pause-before: 20ms; pause-after: 20ms */
h2 { pause: 30ms 40ms } /* pause-before: 30ms; pause-after: 40ms */
h3 { pause-after: 10ms } /* pause-before unspecified; pause-after: 10ms */
```

A.6 Cue properties: 'cue-before', 'cue-after', and 'cue'

'cue-before'

<i>Value:</i>	<uri> none inherit
<i>Initial:</i>	none
<i>Applies to:</i>	all elements
<i>Inherited:</i>	no
<i>Percentages:</i>	N/A
<i>Media:</i>	aural
<i>Computed value:</i>	absolute URI or 'none'

'cue-after'

<i>Value:</i>	<uri> none inherit
<i>Initial:</i>	none
<i>Applies to:</i>	all elements
<i>Inherited:</i>	no
<i>Percentages:</i>	N/A
<i>Media:</i>	aural
<i>Computed value:</i>	absolute URI or 'none'

Auditory icons are another way to distinguish semantic elements. Sounds may be played before and/or after the element to delimit it. Values have the following meanings:

<uri>

The URI must designate an auditory icon resource. If the URI resolves to something other than an audio file, such as an image, the resource should be ignored

and the property treated as if it had the value 'none'.

none

No auditory icon is specified.

Example(s):

```
a {cue-before: url("bell.aiff"); cue-after: url("dong.wav") }
h1 {cue-before: url("pop.au"); cue-after: url("pop.au") }
```

'cue'

Value: [<'cue-before'> || <'cue-after'>] | inherit
Initial: see individual properties
Applies to: all elements
Inherited: no
Percentages: N/A
Media: aural
Computed value: see individual properties

The 'cue' property is a shorthand for setting 'cue-before' and 'cue-after'. If two values are given, the first value is 'cue-before' and the second is 'cue-after'. If only one value is given, it applies to both properties.

Example(s):

The following two rules are equivalent:

```
h1 {cue-before: url("pop.au"); cue-after: url("pop.au") }
h1 {cue: url("pop.au") }
```

If a user agent cannot render an auditory icon (e.g., the user's environment does not permit it), we recommend that it produce an alternative cue.

Please see the sections on the :before and :after pseudo-elements [p. 203] for information on other content generation techniques. 'cue-before' sounds and 'pause-before' gaps are inserted before content from the ':before' pseudo-element. Similarly, 'pause-after' gaps and 'cue-after' sounds are inserted after content from the ':after' pseudo-element.

A.7 Mixing properties: 'play-during'

'play-during'

<i>Value:</i>	<uri> [mix repeat]? auto none inherit
<i>Initial:</i>	auto
<i>Applies to:</i>	all elements
<i>Inherited:</i>	no
<i>Percentages:</i>	N/A
<i>Media:</i>	aural
<i>Computed value:</i>	absolute URI, rest as specified

Similar to the 'cue-before' and 'cue-after' properties, this property specifies a sound to be played as a background while an element's content is spoken. Values have the following meanings:

<uri>

The sound designated by this <uri> is played as a background while the element's content is spoken.

mix

When present, this keyword means that the sound inherited from the parent element's 'play-during' property continues to play and the sound designated by the <uri> is mixed with it. If 'mix' is not specified, the element's background sound replaces the parent's.

repeat

When present, this keyword means that the sound will repeat if it is too short to fill the entire duration of the element. Otherwise, the sound plays once and then stops. This is similar to the 'background-repeat' property. If the sound is too long for the element, it is clipped once the element has been spoken.

auto

The sound of the parent element continues to play (it is not restarted, which would have been the case if this property had been inherited).

none

This keyword means that there is silence. The sound of the parent element (if any) is silent during the current element and continues after the current element.

Example(s):

```
blockquote.sad { play-during: url("violins.aiff") }
blockquote Q   { play-during: url("harp.wav") mix }
span.quiet     { play-during: none }
```

A.8 Spatial properties: 'azimuth' and 'elevation'

Spatial audio is an important stylistic property for aural presentation. It provides a natural way to tell several voices apart, as in real life (people rarely all stand in the same spot in a room). Stereo speakers produce a lateral sound stage. Binaural headphones or the increasingly popular 5-speaker home theater setups can generate full surround sound, and multi-speaker setups can create a true three-dimensional sound stage. VRML 2.0 also includes spatial audio, which implies that in time consumer-priced spatial audio hardware will become more widely available.

'azimuth'

<i>Value:</i>	<angle> [[left-side far-left left center-left center center-right right far-right right-side] behind] leftwards rightwards inherit
<i>Initial:</i>	center
<i>Applies to:</i>	all elements
<i>Inherited:</i>	yes
<i>Percentages:</i>	N/A
<i>Media:</i>	aural
<i>Computed value:</i>	normalized angle

Values have the following meanings:

<angle>

Position is described in terms of an angle within the range '-360deg' to '360deg'. The value '0deg' means directly ahead in the center of the sound stage. '90deg' is to the right, '180deg' behind, and '270deg' (or, equivalently and more conveniently, '-90deg') to the left.

left-side

Same as '270deg'. With 'behind', '270deg'.

far-left

Same as '300deg'. With 'behind', '240deg'.

left

Same as '320deg'. With 'behind', '220deg'.

center-left

Same as '340deg'. With 'behind', '200deg'.

center

Same as '0deg'. With 'behind', '180deg'.

center-right

Same as '20deg'. With 'behind', '160deg'.

right

Same as '40deg'. With 'behind', '140deg'.

far-right

Same as '60deg'. With 'behind', '120deg'.

right-side

Same as '90deg'. With 'behind', '90deg'.

leftwards

Moves the sound to the left, relative to the current angle. More precisely, subtracts 20 degrees. Arithmetic is carried out modulo 360 degrees. Note that 'leftwards' is more accurately described as "turned counter-clockwise," since it *always* subtracts 20 degrees, even if the inherited azimuth is already behind the listener (in which case the sound actually appears to move to the right).

rightwards

Moves the sound to the right, relative to the current angle. More precisely, adds 20 degrees. See 'leftwards' for arithmetic.

This property is most likely to be implemented by mixing the same signal into different channels at differing volumes. It might also use phase shifting, digital delay, and other such techniques to provide the illusion of a sound stage. The precise means used to achieve this effect and the number of speakers used to do so are user agent-dependent; this property merely identifies the desired end result.

Example(s):

```
h1 { azimuth: 30deg }
td.a { azimuth: far-right } /* 60deg */
#12 { azimuth: behind far-right } /* 120deg */
p.comment { azimuth: behind } /* 180deg */
```

If spatial-azimuth is specified and the output device cannot produce sounds *behind* the listening position, user agents should convert values in the rearwards hemisphere to forwards hemisphere values. One method is as follows:

- if $90\text{deg} < x \leq 180\text{deg}$ then $x := 180\text{deg} - x$
- if $180\text{deg} < x \leq 270\text{deg}$ then $x := 540\text{deg} - x$

'elevation'

Value: <angle> | below | level | above | higher | lower | inherit
Initial: level
Applies to: all elements
Inherited: yes
Percentages: N/A
Media: aural
Computed value: normalized angle

Values of this property have the following meanings:

<angle>

Specifies the elevation as an angle, between '-90deg' and '90deg'. '0deg' means on the forward horizon, which loosely means level with the listener. '90deg' means directly overhead and '-90deg' means directly below.

below

Same as '-90deg'.

level

Same as '0deg'.

above

Same as '90deg'.

higher

Adds 10 degrees to the current elevation.

lower

Subtracts 10 degrees from the current elevation.

The precise means used to achieve this effect and the number of speakers used to do so are undefined. This property merely identifies the desired end result.

Example(s):

```
h1 { elevation: above }
tr.a { elevation: 60deg }
tr.b { elevation: 30deg }
tr.c { elevation: level }
```

A.9 Voice characteristic properties: 'speech-rate', 'voice-family', 'pitch', 'pitch-range', 'stress', and 'richness'

'speech-rate'

<i>Value:</i>	<number> x-slow slow medium fast x-fast faster slower inherit
<i>Initial:</i>	medium
<i>Applies to:</i>	all elements
<i>Inherited:</i>	yes
<i>Percentages:</i>	N/A
<i>Media:</i>	aural
<i>Computed value:</i>	number

This property specifies the speaking rate. Note that both absolute and relative keyword values are allowed (compare with 'font-size'). Values have the following meanings:

<number>

Specifies the speaking rate in words per minute, a quantity that varies somewhat by language but is nevertheless widely supported by speech synthesizers.

x-slow

Same as 80 words per minute.

slow

Same as 120 words per minute

medium

Same as 180 - 200 words per minute.

fast

Same as 300 words per minute.

x-fast

Same as 500 words per minute.

faster

Adds 40 words per minute to the current speech rate.

slower

Subtracts 40 words per minutes from the current speech rate.

'voice-family'

<i>Value:</i>	[[<specific-voice> <generic-voice>],]* [<specific-voice> <generic-voice>] inherit
<i>Initial:</i>	depends on user agent
<i>Applies to:</i>	all elements
<i>Inherited:</i>	yes
<i>Percentages:</i>	N/A
<i>Media:</i>	aural
<i>Computed value:</i>	as specified

The value is a comma-separated, prioritized list of voice family names (compare with 'font-family'). Values have the following meanings:

<generic-voice>

Values are voice families. Possible values are 'male', 'female', and 'child'.

<specific-voice>

Values are specific instances (e.g., comedian, trinoids, carlos, lani).

Example(s):

```
h1 { voice-family: announcer, male }
p.part.romeo { voice-family: romeo, male }
p.part.juliet { voice-family: juliet, female }
```

Names of specific voices may be quoted, and indeed must be quoted if any of the words that make up the name does not conform to the syntax rules for identifiers [p. 50] . It is also recommended to quote specific voices with a name consisting of more than one word. If quoting is omitted, any white space [p. 53] characters before and after the voice family name are ignored and any sequence of white space characters inside the voice family name is converted to a single space.

'pitch'

<i>Value:</i>	<frequency> x-low low medium high x-high inherit
<i>Initial:</i>	medium
<i>Applies to:</i>	all elements
<i>Inherited:</i>	yes
<i>Percentages:</i>	N/A
<i>Media:</i>	aural
<i>Computed value:</i>	frequency

Specifies the average pitch (a frequency) of the speaking voice. The average pitch of a voice depends on the voice family. For example, the average pitch for a standard male voice is around 120Hz, but for a female voice, it's around 210Hz.

Values have the following meanings:

<frequency>

Specifies the average pitch of the speaking voice in hertz (Hz).

x-low, low, medium, high, x-high

These values do not map to absolute frequencies since these values depend on the voice family. User agents should map these values to appropriate frequencies based on the voice family and user environment. However, user agents must map these values in order (i.e., 'x-low' is a lower frequency than 'low', etc.).

'pitch-range'

<i>Value:</i>	<number> inherit
<i>Initial:</i>	50
<i>Applies to:</i>	all elements
<i>Inherited:</i>	yes
<i>Percentages:</i>	N/A
<i>Media:</i>	aural
<i>Computed value:</i>	as specified

Specifies variation in average pitch. The perceived pitch of a human voice is determined by the fundamental frequency and typically has a value of 120Hz for a male voice and 210Hz for a female voice. Human languages are spoken with varying inflection and pitch; these variations convey additional meaning and emphasis. Thus, a highly animated voice, i.e., one that is heavily inflected, displays a high pitch range. This property specifies the range over which these variations occur, i.e., how much the fundamental frequency may deviate from the average pitch.

Values have the following meanings:

<number>

A value between '0' and '100'. A pitch range of '0' produces a flat, monotonic voice. A pitch range of 50 produces normal inflection. Pitch ranges greater than 50 produce animated voices.

'stress'

<i>Value:</i>	<number> inherit
<i>Initial:</i>	50
<i>Applies to:</i>	all elements
<i>Inherited:</i>	yes
<i>Percentages:</i>	N/A
<i>Media:</i>	aural
<i>Computed value:</i>	as specified

Specifies the height of "local peaks" in the intonation contour of a voice. For example, English is a **stressed** language, and different parts of a sentence are assigned primary, secondary, or tertiary stress. The value of 'stress' controls the amount of inflection that results from these stress markers. This property is a companion to the 'pitch-range' property and is provided to allow developers to exploit higher-end auditory displays.

Values have the following meanings:

<number>

A value, between '0' and '100'. The meaning of values depends on the language being spoken. For example, a level of '50' for a standard, English-speaking male voice (average pitch = 122Hz), speaking with normal intonation and emphasis would have a different meaning than '50' for an Italian voice.

'richness'

Value: <number> | inherit
Initial: 50
Applies to: all elements
Inherited: yes
Percentages: N/A
Media: aural
Computed value: as specified

Specifies the richness, or brightness, of the speaking voice. A rich voice will "carry" in a large room, a smooth voice will not. (The term "smooth" refers to how the wave form looks when drawn.)

Values have the following meanings:

<number>

A value between '0' and '100'. The higher the value, the more the voice will carry. A lower value will produce a soft, mellifluous voice.

A.10 Speech properties: 'speak-punctuation' and 'speak-numeral'

An additional speech property, 'speak-header', is described below.

'speak-punctuation'

<i>Value:</i>	code none inherit
<i>Initial:</i>	none
<i>Applies to:</i>	all elements
<i>Inherited:</i>	yes
<i>Percentages:</i>	N/A
<i>Media:</i>	aural
<i>Computed value:</i>	as specified

This property specifies how punctuation is spoken. Values have the following meanings:

code

Punctuation such as semicolons, braces, and so on are to be spoken literally.

none

Punctuation is not to be spoken, but instead rendered naturally as various pauses.

'speak-numeral'

<i>Value:</i>	digits continuous inherit
<i>Initial:</i>	continuous
<i>Applies to:</i>	all elements
<i>Inherited:</i>	yes
<i>Percentages:</i>	N/A
<i>Media:</i>	aural
<i>Computed value:</i>	as specified

This property controls how numerals are spoken. Values have the following meanings:

digits

Speak the numeral as individual digits. Thus, "237" is spoken "Two Three Seven".

continuous

Speak the numeral as a full number. Thus, "237" is spoken "Two hundred thirty seven". Word representations are language-dependent.

A.11 Audio rendering of tables

When a table is spoken by a speech generator, the relation between the data cells and the header cells must be expressed in a different way than by horizontal and vertical alignment. Some speech browsers may allow a user to move around in the 2-dimensional space, thus giving them the opportunity to map out the spatially represented relations. When that is not possible, the style sheet must specify at which points the headers are spoken.

A.11.1 Speaking headers: the 'speak-header' property

'speak-header'

<i>Value:</i>	once always inherit
<i>Initial:</i>	once
<i>Applies to:</i>	elements that have table header information
<i>Inherited:</i>	yes
<i>Percentages:</i>	N/A
<i>Media:</i>	aural
<i>Computed value:</i>	as specified

This property specifies whether table headers are spoken before every cell, or only before a cell when that cell is associated with a different header than the previous cell. Values have the following meanings:

once

The header is spoken one time, before a series of cells.

always

The header is spoken before every pertinent cell.

Each document language may have different mechanisms that allow authors to specify headers. For example, in HTML 4 ([HTML4]), it is possible to specify header information with three different attributes ("headers", "scope", and "axis"), and the specification gives an algorithm for determining header information when these attributes have not been specified.

	Meals	Hotels	Transport	subtotals
San Jose				
25-Aug-97	37.74	112.00	45.00	
26-Aug-97	27.28	112.00	45.00	
subtotals	65.02	224.00	90.00	379.02
Seattle				
27-Aug-97	96.25	109.00	36.00	
28-Aug-97	35.00	109.00	36.00	
subtotals	131.25	218.00	72.00	421.25
Totals	196.27	442.00	162.00	800.27

Image of a table with header cells ("San Jose" and "Seattle") that are not in the same column or row as the data they apply to.

This HTML example presents the money spent on meals, hotels and transport in two locations (San Jose and Seattle) for successive days. Conceptually, you can think of the table in terms of an n-dimensional space. The headers of this space are: location, day, category and subtotal. Some cells define marks along an axis while

others give money spent at points within this space. The markup for this table is:

```

<TABLE>
<CAPTION>Travel Expense Report</CAPTION>
<TR>
  <TH></TH>
  <TH>Meals</TH>
  <TH>Hotels</TH>
  <TH>Transport</TH>
  <TH>subtotal</TH>
</TR>
<TR>
  <TH id="san-jose" axis="san-jose">San Jose</TH>
</TR>
<TR>
  <TH headers="san-jose">25-Aug-97</TH>
  <TD>37.74</TD>
  <TD>112.00</TD>
  <TD>45.00</TD>
  <TD></TD>
</TR>
<TR>
  <TH headers="san-jose">26-Aug-97</TH>
  <TD>27.28</TD>
  <TD>112.00</TD>
  <TD>45.00</TD>
  <TD></TD>
</TR>
<TR>
  <TH headers="san-jose">subtotal</TH>
  <TD>65.02</TD>
  <TD>224.00</TD>
  <TD>90.00</TD>
  <TD>379.02</TD>
</TR>
<TR>
  <TH id="seattle" axis="seattle">Seattle</TH>
</TR>
<TR>
  <TH headers="seattle">27-Aug-97</TH>
  <TD>96.25</TD>
  <TD>109.00</TD>
  <TD>36.00</TD>
  <TD></TD>
</TR>
<TR>
  <TH headers="seattle">28-Aug-97</TH>
  <TD>35.00</TD>
  <TD>109.00</TD>
  <TD>36.00</TD>
  <TD></TD>
</TR>
<TR>
  <TH headers="seattle">subtotal</TH>
  <TD>131.25</TD>
  <TD>218.00</TD>
  <TD>72.00</TD>

```

```

    <TD>421.25</TD>
</TR>
<TR>
  <TH>Totals</TH>
  <TD>196.27</TD>
  <TD>442.00</TD>
  <TD>162.00</TD>
  <TD>800.27</TD>
</TR>
</TABLE>

```

By providing the data model in this way, authors make it possible for speech enabled-browsers to explore the table in rich ways, e.g., each cell could be spoken as a list, repeating the applicable headers before each data cell:

```

San Jose, 25-Aug-97, Meals: 37.74
San Jose, 25-Aug-97, Hotels: 112.00
San Jose, 25-Aug-97, Transport: 45.00
...

```

The browser could also speak the headers only when they change:

```

San Jose, 25-Aug-97, Meals: 37.74
  Hotels: 112.00
  Transport: 45.00
26-Aug-97, Meals: 27.28
  Hotels: 112.00
...

```

A.12 Sample style sheet for HTML

This style sheet describes a possible rendering of HTML 4:

```

@media aural {
h1, h2, h3,
h4, h5, h6    { voice-family: paul, male; stress: 20; richness: 90 }
h1            { pitch: x-low; pitch-range: 90 }
h2            { pitch: x-low; pitch-range: 80 }
h3            { pitch: low; pitch-range: 70 }
h4            { pitch: medium; pitch-range: 60 }
h5            { pitch: medium; pitch-range: 50 }
h6            { pitch: medium; pitch-range: 40 }
li, dt, dd    { pitch: medium; richness: 60 }
dt            { stress: 80 }
pre, code, tt { pitch: medium; pitch-range: 0; stress: 0; richness: 80 }
em            { pitch: medium; pitch-range: 60; stress: 60; richness: 50 }
strong        { pitch: medium; pitch-range: 60; stress: 90; richness: 90 }
dfn           { pitch: high; pitch-range: 60; stress: 60 }
s, strike     { richness: 0 }
i             { pitch: medium; pitch-range: 60; stress: 60; richness: 50 }
b             { pitch: medium; pitch-range: 60; stress: 90; richness: 90 }
u             { richness: 0 }
a:link        { voice-family: harry, male }
a:visited     { voice-family: betty, female }
a:active      { voice-family: betty, female; pitch-range: 80; pitch: x-high }
}

```

A.13 Emacspeak

For information, here is the list of properties implemented by Emacspeak, a speech subsystem for the Emacs editor.

- voice-family
- stress (but with a different range of values)
- richness (but with a different range of values)
- pitch (but with differently named values)
- pitch-range (but with a different range of values)

(We thank T. V. Raman for the information about implementation status of aural properties.)

Appendix B. Bibliography

Contents

B.1 Normative references	325
B.2 Informative references	327

B.1 Normative references

[COLORIMETRY]

"Colorimetry", Third Edition, Commission Internationale de l'Eclairage, CIE Publication 15:2004, ISBN 3-901-906-33-9.

Available at <http://www.cie.co.at/publ/abst/15-2004.html> [p. ??]

[FLEX]

"Flex: The Lexical Scanner Generator", Version 2.3.7, ISBN 1882114213.

[HTML4]

"HTML 4.01 Specification", D. Raggett, A. Le Hors, I. Jacobs, 24 December 1999.

The latest version of the specification is available at

<http://www.w3.org/TR/html4/> [p. ??]. The Recommendation defines three document type definitions: Strict, Transitional, and Frameset, all reachable from the Recommendation.

[ICC42]

Specification ICC.1:2004-10 (Profile version 4.2.0.0) Image technology colour management – Architecture, profile format, and data structure.

Available at http://www.color.org/icc_specs2.html [p. ??]

[ISO8879]

"ISO 8879:1986(E): Information processing - Text and Office Systems - Standard Generalized Markup Language (SGML)", International Organization for Standardization (ISO), 15 October 1986.

[ISO10646]

"Information Technology - Universal Multiple- Octet Coded Character Set (UCS) - Part 1: Architecture and Basic Multilingual Plane", ISO/IEC 10646-1:2003.

Useful roadmap of the BMP and plane 1 [p. ??] documents show which scripts sit at which numeric ranges.

[PNG]

"Portable Network Graphics (PNG) Specification (Second Edition)", David Duce, ed., 10 November 2003.

Available at <http://www.w3.org/TR/PNG/> [p. ??].

[RFC3986]

"Uniform Resource Identifier (URI): Generic Syntax," T. Berners-Lee, R. Fielding, L. Masinter, January 2005.

Available at <http://www.ietf.org/rfc/rfc3986> [p. ??].

[RFC2045]

"Multipurpose Internet Mail Extensions (MIME) Part One: Format of Internet Message Bodies", N. Freed and N. Borenstein, November 1996.
Available at <http://www.ietf.org/rfc/rfc2045.txt> [p. ??] . Note that this RFC obsoletes RFC1521, RFC1522, and RFC1590.

[RFC2616]

"HTTP Version 1.1 ", R. Fielding, J. Gettys, J. Mogul, et al., June 1999.
Available at <http://www.ietf.org/rfc/rfc2616.txt> [p. ??] .

[RFC2119]

"Key words for use in RFCs to Indicate Requirement Levels", S. Bradner, March 1997.
Available at <http://www.ietf.org/rfc/rfc2119.txt> [p. ??] .

[RFC2318]

"The text/css Media Type", H. Lie, B. Bos, C. Lilley, March 1998.
Available at <http://www.ietf.org/rfc/rfc2318.txt> [p. ??] .

[SRGB]

IEC 61966-2-1 (1999-10) - "Multimedia systems and equipment - Colour measurement and management - Part 2-1: Colour management - Default RGB colour space - sRGB, ISBN: 2-8318-4989-6 - ICS codes: 33.160.60, 37.080 - TC 100 - 51 pp.
Available at <http://domino.iec.ch/webstore/webstore.nsf/artnum/025408> [p. ??]

[UAAG10]

"User Agent Accessibility Guidelines 1.0." Ian Jacobs, Jon Gunderson, Eric Hansen (editors). 17 December 2002.
Available at <http://www.w3.org/TR/2002/REC-UAAG10-20021217> [p. ??]

[UAX9]

"Unicode Bidirectional Algorithm", Mark Davis. (Unicode Standard Annex #9.) 22 September 2009.
Available at <http://www.unicode.org/reports/tr9/> [p. ??]

[UNICODE]

The Unicode Consortium. The Unicode Standard, Version 4.1.0, defined by: The Unicode Standard, Version 4.0 (Boston, MA, Addison-Wesley, 2003. ISBN 0-321-18578-1), as amended by Unicode 4.0.1 [p. ??] and Unicode 4.1.0 [p. ??] and as updated from time to time by the publication of new versions. (See <http://www.unicode.org/unicode/standard/versions/> [p. ??] for the latest version and additional information on versions of the standard and of the Unicode Character Database).
Available at <http://www.unicode.org/versions/Unicode4.1.0/> [p. ??]

[XML10]

"Extensible Markup Language (XML) 1.0 (third edition)" T. Bray, J. Paoli, C.M. Sperberg-McQueen, Eve Maler, François Yergeau, editors, 4 February 2004.
Available at <http://www.w3.org/TR/REC-xml/> [p. ??] .

[YACC]

"YACC - Yet another compiler compiler", S. C. Johnson, Technical Report, Murray Hill, 1975.

B.2 Informative references

[CHARSETS]

Registered charset values. Download a list of registered charset values from <http://www.iana.org/assignments/character-sets> [p. ??] .

[CSS1]

"Cascading Style Sheets, level 1", H. W. Lie and B. Bos, 17 December 1996, revised 11 January 1999

The latest version is available at <http://www.w3.org/TR/CSS1> [p. ??]

[CSS2]

"Cascading Style Sheets, level 2, CSS2 Specification", B. Bos, H. W. Lie, C. Lilley and I. Jacobs, 12 May 1998 (revised 11 April 2008), <http://www.w3.org/TR/2008/REC-CSS2-20080411/> [p. ??]

[CSS3COLOR]

"CSS3 Color Module," Tantek Çelik, Chris Lilley, 14 May 2003, W3C Candidate Recommendation. Available at

<http://www.w3.org/TR/2003/CR-css3-color-20030514/> [p. ??]

[CSS3LIST]

"CSS3 module: lists," Tantek Çelik, Ian Hickson, 7 November 2002, W3C working draft (work in progress). Available at

<http://www.w3.org/TR/2002/WD-css3-lists-20021107> [p. ??]

[CSS3SEL]

"Selectors", D. Glazman, T. Çelik, I. Hickson, 13 November 2001

Available at <http://www.w3.org/TR/2001/CR-css3-selectors-20011113> [p. ??]

[CSS3SPEECH]

"CSS3 Speech Module", David Raggett, Daniel Glazman, Claudio Santambrogio, 14 May 2003, W3C Working Draft (work in progress). Available at

<http://www.w3.org/TR/2004/WD-css3-speech-20041216> [p. ??]

[DOM-LEVEL-3-CORE]

"Document Object Model (DOM) Level 3 Core Specification", A. Le Hors, P. Le Hégarret, et al. (eds.), 7 April 2004, W3C Recommendation. Available at

<http://www.w3.org/TR/2004/REC-DOM-Level-3-Core-20040407/> [p. ??] .

[MATH20]

"Mathematical Markup Language (MathML) Version 2.0", D. Carlisle, P. Ion, R. Miner, N. Poppelier, 21 February 2001

Available at <http://www.w3.org/TR/2001/REC-MathML2-20010221> [p. ??]

[MEDIAQ]

"Media Queries", Håkon Wium Lie, Tantek Çelik, Daniel Glazman, Anne van Kesteren, 23 April 2009

(Work in progress.) Available at <http://www.w3.org/TR/2009/CR-css3-mediaqueries-20090423/> [p. ??]

[P3P]

"The Platform for Privacy Preferences 1.0 (P3P1.0) Specification", L. Cranor, M. Langheinrich, M. Marchiori, M. Presler-Marshall, J. Reagle, 16 April 2002

Available at <http://www.w3.org/TR/2002/REC-P3P-20020416> [p. ??]

[BCP47]

"Tags for Identifying Languages", A. Phillips, M. Davis, September 20091.
Available at <http://www.rfc-editor.org/rfc/bcp/bcp47.txt> [p. ??] .

[SVG11]

"Scalable Vector Graphics (SVG) 1.1 Specification", J. Ferraiolo, et.al. 14
January 2003

Available at <http://www.w3.org/TR/2003/REC-SVG11-20030114> [p. ??]

[WAI-PAGEAUTH]

"Web Content Accessibility Guidelines", W. Chisholm, G. Vanderheiden, I.
Jacobs eds.

Available at: <http://www.w3.org/TR/WAI-WEBCONTENT/> [p. ??] .

[XHTML]

"XHTML 1.0 The Extensible HyperText Markup Language", various authors,
Available at: <http://www.w3.org/TR/xhtml1/> [p. ??] .

[XMLID]

"xml:id Version 1.0", J. Marsh, D. Veillard N. Walsh, 9 November 2004, W3C
working draft (work in progress). Available at:

<http://www.w3.org/TR/2004/WD-xml-id-20041109/> [p. ??] .

[XMLNAMESPACES]

"Namespaces in XML", T. Bray, D. Hollander, A. Layman,

Available at: <http://www.w3.org/TR/1999/REC-xml-names-19990114> [p. ??] .

Appendix C. Changes

Contents

C.1 Additional property values	341
C.1.1 Section 4.3.6 Colors	341
C.1.2 Section 9.2.4 The 'display' property	341
C.1.3 Section 12.2 The 'content' property	341
C.1.4 Section 16.6 White space: the 'white-space' property	341
C.1.5 Section 18.1 Cursors: the 'cursor' property	341
C.2 Changes	342
C.2.1 Section 1.1 CSS 2.1 vs CSS 2	342
C.2.2 Section 1.2 Reading the specification	342
C.2.3 Section 1.3 How the specification is organized	342
C.2.4 Section 1.4.2.1 Value	342
C.2.5 Section 1.4.2.6 Media groups	342
C.2.6 Section 1.4.2.7 Computed value	342
C.2.7 Section 1.4.4 Notes and examples	342
C.2.8 Section 1.5 Acknowledgments	342
C.2.9 Section 3.2 Conformance	343
C.2.10 Section 3.3 Error Conditions	343
C.2.11 Section 4.1.1 Tokenization	343
C.2.12 Section 4.1.3 Characters and case	343
C.2.13 Section 4.2 Rules for handling parsing errors	344
C.2.14 Section 4.3 Values	344
C.2.15 Section 4.3.2 Lengths	344
C.2.16 Section 4.3.4 URLs and URIs	344
C.2.17 Section 4.3.5 Counters	344
C.2.18 Section 4.3.6 Colors	344
C.2.19 Section 4.3.8 Unsupported Values	344
C.2.20 Section 4.4 CSS style sheet representation	344
C.2.21 Section 5.8.1 Matching attributes and attribute values	345
C.2.22 Section 5.8.3 Class selectors	345
C.2.23 Section 5.9 ID selectors	345
C.2.24 Section 5.10 Pseudo-elements and pseudo-classes	345
C.2.25 Section 5.11.2 The link pseudo-classes: :link and :visited	345
C.2.26 Section 5.11.4 The language pseudo-class: :lang	345
C.2.27 Section 5.12.1 The :first-line pseudo-element	346
C.2.28 Section 5.12.2 The :first-letter pseudo-element	346
C.2.29 Section 6.1 Specified, computed, and actual values	346
C.2.30 Section 6.4.1 Cascading order	346
C.2.31 Section 6.4.3 Calculating a selector's specificity	347

C.2.32 Section 6.4.4 Precedence of non-CSS presentational hints . 347

C.2.33 Section 7.3 Recognized Media Types 347

C.2.34 Section 7.3.1 Media Groups 347

C.2.35 Section 8.3 Margin properties 347

C.2.36 Section 8.3.1 Collapsing margins 347

C.2.37 Section 8.4 Padding properties 348

C.2.38 Section 8.5.2 Border color 348

C.2.39 Section 8.5.3 Border style 348

C.2.40 Section 8.6 The box model for inline elements in bidirectional context 348

C.2.41 Section 9.1.2 Containing blocks 348

C.2.42 Section 9.2.1.1 Anonymous block boxes 348

C.2.43 Section 9.2.2.1 Anonymous inline boxes 348

C.2.44 Section 9.2.3 Run-in boxes 348

C.2.45 Section 9.2.4 The 'display' property 348

C.2.46 Section 9.3.1 Choosing a positioning scheme 349

C.2.47 Section 9.3.2 Box offsets 349

C.2.48 Section 9.4.1 Block formatting contexts 349

C.2.49 Section 9.4.2 Inline formatting context 349

C.2.50 Section 9.4.3 Relative positioning 350

C.2.51 Section 9.5 Floats 350

C.2.52 Section 9.5.1 Positioning the float 350

C.2.53 Section 9.5.2 Controlling flow next to floats 350

C.2.54 Section 9.7 Relationships between 'display', 'position', and 'float' 350

C.2.55 Section 9.9 Layered presentation 351

C.2.56 Section 9.10 Text direction 351

C.2.57 Chapter 10 Visual formatting model details 351

C.2.58 Section 10.1 Definition of "containing block" 351

C.2.59 Section 10.2 Content width 352

C.2.60 Section 10.3 Calculating widths and margins 352

C.2.61 Section 10.3.2 Inline, replaced elements 352

C.2.62 Section 10.3.3 Block-level, non-replaced elements in normal flow 352

C.2.63 Section 10.3.4 Block-level, replaced elements in normal flow . 352

C.2.64 Section 10.3.5 Floating, non-replaced elements 352

C.2.65 Section 10.3.6 Floating, replaced elements 352

C.2.66 Section 10.3.7 Absolutely positioned, non-replaced elements . 353

C.2.67 Section 10.3.8 Absolutely positioned, replaced elements . . 353

C.2.68 Section 10.4 Minimum and maximum widths 353

C.2.69 Section 10.5 Content height 353

C.2.70 Section 10.6 Calculating heights and margins 354

C.2.71 Section 10.6.1 Inline, non-replaced elements 354

C.2.72 Section 10.6.2 Inline replaced elements, block-level replaced elements in normal flow, 'inline-block' replaced elements in normal flow and

floating replaced elements	354
C.2.73 Section 10.6.3 Block-level non-replaced elements in normal flow when 'overflow' computes to 'visible'	354
C.2.74 Section 10.6.4 Absolutely positioned, non-replaced elements	354
C.2.75 Section 10.6.5 Absolutely positioned, replaced elements	355
C.2.76 Section 10.7 Minimum and maximum heights	355
C.2.77 Section 10.8 Line height calculations	355
C.2.78 Section 10.8.1 Leading and half-leading	355
C.2.79 Section 11.1 Overflow and clipping	355
C.2.80 Section 11.1.1 Overflow	355
C.2.81 Section 11.1.2 Clipping: the 'clip' property	356
C.2.82 Section 11.2 Visibility	356
C.2.83 Chapter 12 Generated content, automatic numbering, and lists	356
C.2.84 Section 12.1 The :before and :after pseudo-elements	356
C.2.85 Section 12.2 The 'content' property	356
C.2.86 Section 12.3.2 Inserting quotes with the 'content' property	357
C.2.87 Section 12.4 Automatic counters and numbering	357
C.2.88 Section 12.4.1 Nested counters and scope	357
C.2.89 Section 12.5 Lists	357
C.2.90 Section 12.5.1 Lists	357
C.2.91 Chapter 13 Paged media	358
C.2.92 Section 13.2.2 Page selectors	358
C.2.93 Section 13.3.1 Page break properties	358
C.2.94 Section 13.3.3 Allowed page breaks	358
C.2.95 Section 14.2.1 Background properties	358
C.2.96 Section 14.3 Gamma correction	358
C.2.97 Chapter 15 Fonts	359
C.2.98 Section 15.2 Font matching algorithm	359
C.2.99 Section 15.2.2 Font family	359
C.2.100 Section 15.5 Small-caps	359
C.2.101 Section 15.6 Font boldness	359
C.2.102 Section 15.7 Font size	359
C.2.103 Chapter 16 Text	359
C.2.104 Section 16.2 Alignment	360
C.2.105 Section 16.3.1 Underlining, over lining, striking, and blinking	360
C.2.106 Section 16.4 Letter and word spacing	360
C.2.107 Section 16.5 Capitalization	360
C.2.108 Section 16.6 White space	360
C.2.109 Chapter 17 Tables	361
C.2.110 Section 17.2 The CSS table model	361
C.2.111 Section 17.2.1 Anonymous table objects	361
C.2.112 Section 17.4 Tables in the visual formatting model	361
C.2.113 Section 17.4.1 Caption position and alignment	362

C.2.114	Section 17.5	Visual layout of table contents	362
C.2.115	Section 17.5.1	Table layers and transparency	362
C.2.116	Section 17.5.2.1	Fixed table layout	362
C.2.117	Section 17.5.2.2	Automatic table layout	362
C.2.118	Section 17.5.3	Table height algorithms	362
C.2.119	Section 17.5.4	Horizontal alignment in a column	362
C.2.120	Section 17.6	Borders	363
C.2.121	Section 17.6.1	The separated borders model	363
C.2.122	Section 17.6.1.1	Borders and Backgrounds around empty cells	363
C.2.123	Section 17.6.2	The collapsing border model	363
C.2.124	Section 17.6.2.1	Border conflict resolution	363
C.2.125	Section 18.1	Cursors: the 'cursor' property	363
C.2.126	Section 18.4	Dynamic outlines	363
C.2.127	Chapter 12	Generated content, automatic numbering, and lists	364
C.2.128	Appendix A	Aural style sheets	364
C.2.129	Appendix A Section 5	Pause properties	364
C.2.130	Appendix A Section 6	Cue properties	364
C.2.131	Appendix A Section 7	Mixing properties	364
C.2.132	Appendix B	Bibliography	364
C.2.133	Other		365
C.3	Errors		365
C.3.1	Shorthand properties		365
C.3.2	Applies to		365
C.3.3	Section 4.1.1 (and G2)		365
C.3.4	Section 4.1.3	Characters and case	366
C.3.5	Section 4.3	(Double sign problem)	366
C.3.6	Section 4.3.2	Lengths	366
C.3.7	Section 4.3.3	Percentages	366
C.3.8	Section 4.3.4	URLs and URIs	366
C.3.9	Section 4.3.5	Counters	366
C.3.10	Section 4.3.6	Colors	366
C.3.11	Section 4.3.7	Strings	367
C.3.12	Section 5.10	Pseudo-elements and pseudo-classes	367
C.3.13	Section 6.4	The cascade	367
C.3.14	Section 8.1	Box Dimensions	367
C.3.15	Section 8.2	Example of margins, padding, and borders	367
C.3.16	Section 8.5.4	Border shorthand properties	367
C.3.17	Section 9.2.1	Block-level elements and block boxes	367
C.3.18	Section 9.3.1	Choosing a positioning scheme	367
C.3.19	Section 9.3.2	Box offsets	368
C.3.20	Section 9.4.1	Block formatting contexts	368
C.3.21	Section 9.4.2	Inline formatting context	368
C.3.22	Section 9.4.3	Relative positioning	368

C.3.23	Section 9.5	Floats	368
C.3.24	Section 9.5.1	Positioning the float	368
C.3.25	Section 9.5.2	Controlling flow next to floats	368
C.3.26	Section 9.6	Absolute positioning	369
C.3.27	Section 9.7	Relationships between 'display', 'position', and 'float'	369
C.3.28	Section 9.10	Text direction	369
C.3.29	Section 10.1	Definition of "containing block"	369
C.3.30	Section 10.3.3	Block-level, non-replaced elements in normal flow	369
C.3.31	Section 10.4	Minimum and maximum widths	369
C.3.32	Section 10.6.3	Block-level non-replaced elements in normal flow when 'overflow' computes to 'visible'	369
C.3.33	Section 10.7	Minimum and maximum heights	370
C.3.34	Section 11.1.1	Overflow	370
C.3.35	Section 11.1.2	Clipping: the 'clip' property	370
C.3.36	Section 11.2	Visibility	370
C.3.37	Section 12.4.2	Counter styles	370
C.3.38	Section 12.6.2	Lists	370
C.3.39	Section 14.2	The background	371
C.3.40	Section 14.2.1	Background properties	371
C.3.41	Section 15.2	Font matching algorithm	371
C.3.42	Section 15.7	Font size	371
C.3.43	Section 16.1	Indentation	371
C.3.44	Section 16.2	Alignment	371
C.3.45	Section 17.2	The CSS table model	372
C.3.46	Section 17.2.1	Anonymous table objects	372
C.3.47	Section 17.4	Tables in the visual formatting model	372
C.3.48	Section 17.5	Visual layout of table contents	372
C.3.49	Section 17.5.1	Table layers and transparency	373
C.3.50	Section 17.6.1	The separated borders model	373
C.3.51	Section 18.2	System Colors	373
C.3.52	Section E.2	Painting order	373
C.4	Clarifications		373
C.4.1	Section 2.1	A brief CSS 2.1 tutorial for HTML	373
C.4.2	Section 2.2	A brief CSS 2.1 tutorial for XML	373
C.4.3	Section 2.3	The CSS 2.1 processing model	374
C.4.4	Section 3.1	Definitions	374
C.4.5	Section 4.1	Syntax	374
C.4.6	Section 4.1.1	Tokenization	374
C.4.7	Section 4.1.3	Characters and case	374
C.4.8	Section 4.1.7	Rule sets, declaration blocks, and selectors	375
C.4.9	Section 4.2	Rules for handling parsing errors	375
C.4.10	Section 4.3.1	Integers and real numbers	375
C.4.11	Section 4.3.2	Lengths	375

C.4.12	Section 4.3.4	URLs and URIs	375
C.4.13	Section 5.1	Pattern matching	375
C.4.14	Section 5.7	Adjacent sibling selectors	375
C.4.15	Section 5.8.1	Matching attributes and attribute values	375
C.4.16	Section 5.8.2	Default attribute values in DTDs	375
C.4.17	Section 5.9	ID selectors	376
C.4.18	Section 5.11.3	The dynamic pseudo-classes: :hover, :active, and :focus	376
C.4.19	Section 5.11.4	The language pseudo-class: :lang	376
C.4.20	Section 5.12.2	The :first-letter pseudo-element	376
C.4.21	Section 6.2	Inheritance	376
C.4.22	Section 6.2.1	The 'inherit' value	376
C.4.23	Section 6.3	The @import rule	376
C.4.24	Section 6.4	The Cascade	376
C.4.25	Section 6.4.1	Cascading order	376
C.4.26	Section 6.4.3	Calculating a selector's specificity	377
C.4.27	Section 7.2.1	The @media rule	377
C.4.28	Section 7.3	Recognized media types	377
C.4.29	Section 7.3.1	Media groups	377
C.4.30	Section 8.1	Box dimensions	377
C.4.31	Section 8.3	Margin properties	377
C.4.32	Section 8.3.1	Collapsing margins	377
C.4.33	Section 8.5.3	Border style	378
C.4.34	Section 9.1.1	The viewport	378
C.4.35	Section 9.2.4	The 'display' property	378
C.4.36	Section 9.3.1	Choosing a positioning scheme	378
C.4.37	Section 9.3.2	Box offsets	378
C.4.38	Section 9.4.2	Inline formatting context	378
C.4.39	Section 9.4.3	Relative positioning	379
C.4.40	Section 9.5	Floats	379
C.4.41	Section 9.5.1	Positioning the float	379
C.4.42	Section 9.5.2	Controlling flow next to floats	379
C.4.43	Section 9.8	Comparison of normal flow, floats, and absolute positioning	379
C.4.44	Section 10.1	Definition of "containing block"	379
C.4.45	Section 10.2	Content width	380
C.4.46	Section 10.3.3	Block-level, non-replaced elements in normal flow	380
C.4.47	Section 10.3.8	Absolutely positioning, replaced elements	380
C.4.48	Section 10.4	Minimum and maximum widths	380
C.4.49	Section 10.6	Calculating heights and margins	380
C.4.50	Section 10.7	Minimum and maximum heights	380
C.4.51	Section 10.8	Line height calculations	380
C.4.52	Section 10.8.1	Leading and half-leading	380

C.4.53	Section 11.1	Overflow and clipping	380
C.4.54	Section 11.1.1	Overflow	381
C.4.55	Section 11.1.2	Clipping	381
C.4.56	Section 11.2	Visibility	381
C.4.57	Section 12.1	The :before and :after pseudo-elements	381
C.4.58	Section 12.2	The 'content' property	381
C.4.59	Section 12.3.2	Inserting quotes with the 'content' property	381
C.4.60	Section 12.4	Automatic counters and numbering	382
C.4.61	Section 12.4.3	Counters in elements with 'display: none'	382
C.4.62	Section 14.2	The background	382
C.4.63	Section 15.1	Fonts Introduction	382
C.4.64	Section 15.2	Font matching algorithm	383
C.4.65	Section 15.2.2	Font family	383
C.4.66	Section 15.3.1	Generic font families	383
C.4.67	Section 15.4	Font styling	383
C.4.68	Section 15.5	Small-caps	383
C.4.69	Section 15.6	Font boldness	383
C.4.70	Section 15.7	Font size	383
C.4.71	Section 16.1	Indentation	384
C.4.72	Section 16.2	Alignment	384
C.4.73	Section 16.3.1	Underlining, over lining, striking, and blinking	384
C.4.74	Section 16.5	Capitalization	384
C.4.75	Section 16.6	White space	384
C.4.76	Section 17.1	Introduction to tables	384
C.4.77	Section 17.2	The CSS table model	384
C.4.78	Section 17.2.1	Anonymous table objects	384
C.4.79	Section 17.4	Tables in the visual formatting model	385
C.4.80	Section 17.5	Visual layout of table contents	385
C.4.81	Section 17.5.1	Table layers and transparency	385
C.4.82	Section 17.5.2	Table width algorithms	385
C.4.83	Section 17.5.2.1	Fixed table layout	385
C.4.84	Section 17.5.2.2	Automatic table layout	386
C.4.85	Section 17.5.4	Horizontal alignment in a column	386
C.4.86	Section 17.5.5	Dynamic row and column effects	386
C.4.87	Section 17.6.1	The separated borders model	386
C.4.88	Section 17.6.2	The collapsing borders model	386
C.4.89	Section 18.2	System Colors	386
C.4.90	Section 18.4	Dynamic outlines	386
C.4.91	Section 18.4.1	Outlines and the focus	387
C.4.92	Appendix D	Default style sheet for HTML 4	387
C.5	Errata since the Candidate Recommendation of July 2007		387
C.5.1	Section 1.4.2.1	Value	387
C.5.2	Section 2.3	The CSS 2.1 processing model	387

C.5.3 Section 3.1 Definitions	387
C.5.4 Section 4.1.1 Tokenization	387
C.5.5 Section 4.1.2.2 Informative Historical Notes	388
C.5.6 Section 4.1.3 Characters and case	388
C.5.7 Section 4.1.3 Characters and case	388
C.5.8 Section 4.1.3 Characters and case	388
C.5.9 Section 4.1.3 Characters and case	388
C.5.10 Section 4.1.5 At-rules	388
C.5.11 Section 4.1.7 Rule sets, declaration blocks, and selectors	389
C.5.12 Section 4.2 Rules for handling parsing errors	389
C.5.13 Section 4.2 Rules for handling parsing errors	389
C.5.14 Section 4.3.2 Lengths	389
C.5.15 Section 4.3.5 Counters	389
C.5.16 Section 5.8.1 Matching attributes and attribute values	390
C.5.17 Section 5.8.2 Default attribute values in DTDs	390
C.5.18 Section 5.11.4 The language pseudo-class: :lang	390
C.5.19 Section 5.12.3 The :before and :after pseudo-elements	390
C.5.20 Section 6.3 The @import rule	390
C.5.21 Section 6.3 The @import rule	390
C.5.22 Section 6.4.1 Cascading order	391
C.5.23 Section 6.4.1 Cascading order	391
C.5.24 Section 7.2.1 The @media rule	391
C.5.25 Section 8.3.1 Collapsing margins	391
C.5.26 Section 8.3.1 Collapsing margins	391
C.5.27 Section 8.3.1 Collapsing margins	391
C.5.28 Section 9.2.2 Inline-level elements and inline boxes	392
C.5.29 Section 9.2.4 The 'display' property	392
C.5.30 Section 9.3.2 Box offsets: 'top', 'right', 'bottom', 'left'	392
C.5.31 Section 9.5 Floats	392
C.5.32 Section 9.5 Floats	392
C.5.33 Section 9.5.2 Controlling flow next to floats: the 'clear' property	392
C.5.34 Section 9.6.1 Fixed positioning	393
C.5.35 Section 9.9.1 Specifying the stack level: the 'z-index' property	393
C.5.36 Section 10.1 Definition of "containing block"	393
C.5.37 Section 10.3 Calculating widths and margins	393
C.5.38 Section 10.3.1 Inline, non-replaced elements	394
C.5.39 Section 10.3.2 Inline, replaced elements	394
C.5.40 Section 10.3.2 Inline, replaced elements	394
C.5.41 Section 10.3.3 Block-level, non-replaced elements in normal flow	394
C.5.42 Section 10.3.7 Absolutely positioned, non-replaced elements	395
C.5.43 Section 10.3.7 Absolutely positioned, non-replaced elements	395
C.5.44 Section 10.3.8 Absolutely positioned, replaced elements	395
C.5.45 Section 10.3.8 Absolutely positioned, replaced elements	395

C.5.46	Section 10.3.8 Absolutely positioned, replaced elements	396
C.5.47	Section 10.5 Content height: the 'height' property	396
C.5.48	Section 10.6.2 Inline replaced elements [□]	396
C.5.49	Section 10.6.4 Absolutely positioned, non-replaced elements	396
C.5.50	Section 10.6.5 Absolutely positioned, replaced elements	396
C.5.51	Section 10.8.1 Leading and half-leading	396
C.5.52	Section 11.1.1 Overflow: the 'overflow' property	397
C.5.53	Section 11.1.2 Clipping: the 'clip' property	397
C.5.54	Section 12.2 The 'content' property	397
C.5.55	Section 12.4.2 Counter styles	397
C.5.56	Section 12.5 Lists	397
C.5.57	Section 12.5.1 Lists: the 'list-style-type', 'list-style-image', 'list-style-position', and 'list-style' properties	398
C.5.58	Section 12.5.1 Lists: the 'list-style-type', 'list-style-image', 'list-style-position', and 'list-style' properties	398
C.5.59	Section 12.5.1 Lists: the 'list-style-type', 'list-style-image', 'list-style-position', and 'list-style' properties	398
C.5.60	Section 13.2 Page boxes: the @page rule	398
C.5.61	Section 13.2.1.1 Rendering page boxes that do not fit a target sheet	399
C.5.62	Section 13.2.3 Content outside the page box	399
C.5.63	Section 13.3.1 Page break properties: 'page-break-before', 'page-break-after', 'page-break-inside'	399
C.5.64	Section 13.3.1 Page break properties: 'page-break-before', 'page-break-after', 'page-break-inside'	399
C.5.65	Section 13.3.2 Breaks inside elements: 'orphans', 'widows'	399
C.5.66	Section 13.3.2 Breaks inside elements: 'orphans', 'widows'	399
C.5.67	Section 13.3.3 Allowed page breaks	399
C.5.68	Section 13.3.3 Allowed page breaks	400
C.5.69	Section 13.3.3 Allowed page breaks	400
C.5.70	Section 13.3.5 "Best" page breaks	400
C.5.71	Section 14.2 The background	400
C.5.72	Section 14.2 The background	400
C.5.73	Section 14.2.1 Background properties: 'background-color', 'background-image', 'background-repeat', 'background-attachment', 'background-position', and 'background'	401
C.5.74	Section 15.6 Font boldness: the 'font-weight' property	401
C.5.75	Section 16.6 Whitespace: the 'white-space' property	401
C.5.76	Section 16.6.1 The 'white-space' processing model	402
C.5.77	Section 17.2.1 Anonymous table objects	402
C.5.78	Section 17.2.1 Anonymous table objects	402
C.5.79	Section 17.4 Tables in the visual formatting model	402
C.5.80	Section 17.5.4 Horizontal alignment in a column	402
C.5.81	Section 18.1 Cursors: the 'cursor' property	403
C.5.82	Section B.2 Informative references	403

C.5.83	Appendix D. Default style sheet for HTML 4	403
C.5.84	Appendix D. Default style sheet for HTML 4	403
C.5.85	Section E.2 Painting order	403
C.5.86	Appendix G. Grammar of CSS 2.1	403
C.5.87	Section G.1 Grammar	404
C.5.88	Section G.2 Lexical scanner	404
C.5.89	Section G.2 Lexical scanner	404
C.5.90	Section G.2 Lexical scanner	404
C.5.91	Section G.2 Lexical scanner	404
C.5.92	Appendix I. Index	404
C.6	Errata since the Candidate Recommendation of April 2009	405
C.6.1	Section 4.2 Rules for handling parsing errors	405
C.6.2	Section 13.3.3 Allowed page breaks	405
C.6.3	Section 15.3 Font family: the 'font-family' property	405
C.6.4	Section 15.3.1.1 serif	405
C.6.5	Section 15.7 Font size: the 'font-size' property	405
C.6.6	Section 17.5.2.1 Fixed table layout	406
C.6.7	Section 17.5.3 Table height layout	406
C.6.8	Appendix G. Grammar of CSS 2.1	406
C.7	Errata since the Candidate Recommendation of September 2009	406
C.7.1	Section 1.4.2.1 Value	406
C.7.2	Section 3.1 Definitions	406
C.7.3	Section 4.1.1 Tokenization	407
C.7.4	Section 4.1.1 Tokenization	407
C.7.5	Section 4.1.1 Tokenization	407
C.7.6	Section 4.1.1 Tokenization	407
C.7.7	Section 4.1.2.2 Informative Historical Notes	408
C.7.8	Section 4.1.3 Characters and case	408
C.7.9	Section 4.1.3 Characters and case	408
C.7.10	Section 4.1.8 Declarations and properties	408
C.7.11	Section 4.2 Rules for handling parsing errors	408
C.7.12	Section 4.3.2 Lengths	408
C.7.13	Section 4.3.2 Lengths	408
C.7.14	Section 4.3.4 URLs and URIs	409
C.7.15	Section 4.3.4 URLs and URIs	409
C.7.16	Section 5.8.2 Default attribute values in DTDs	409
C.7.17	Section 5.11.4 The language pseudo-class: :lang	409
C.7.18	Section 5.12 Pseudo-elements	409
C.7.19	Section 5.12.1 The :first-line pseudo-element	410
C.7.20	Section 5.12.2 The :first-letter pseudo-element	410
C.7.21	Section 6.2 Inheritance	410
C.7.22	Section 6.4.4 Precedence of non-CSS presentational hints	410
C.7.23	Section 7.3 Recognized media types	410

C.7.24 Section 8.3.1 Collapsing margins 411

C.7.25 Section 8.3.1 Collapsing margins 411

C.7.26 Section 9.2.1 Block-level elements and block boxes 411

C.7.27 Section 9.2.1.1 Anonymous block boxes 411

C.7.28 Section 9.2.1.1 Anonymous block boxes 412

C.7.29 Section 9.2.1.1 Anonymous block boxes 412

C.7.30 Section 9.2.1.1 Anonymous block boxes 412

C.7.31 Section 9.2.2 Inline-level elements and inline boxes 412

C.7.32 Section 9.2.3 Run-in boxes 412

C.7.33 Section 9.2.4 The 'display' property 413

C.7.34 Section 9.2.4 The 'display' property 413

C.7.35 Section 9.3 Positioning schemes 414

C.7.36 Section 9.4 Normal flow 414

C.7.37 Section 9.3.2 Box offsets: 'top', 'right', 'bottom', 'left' 414

C.7.38 Section 9.5 Floats 415

C.7.39 Section 9.5 Floats 415

C.7.40 Section 9.5.2 Controlling flow next to floats: the 'clear' property 416

C.7.41 Section 9.5.2 Controlling flow next to floats: the 'clear' property 416

C.7.42 Section 9.5.2 Controlling flow next to floats: the 'clear' property 416

C.7.43 Section 9.5.2 Controlling flow next to floats: the 'clear' property 417

C.7.44 Section 9.6.1 Fixed positioning 417

C.7.45 Section 9.9.1 Specifying the stack level: the 'z-index' property . 417

C.7.46 Section 9.10 Text direction: the 'direction' and 'unicode-bidi' proper-
ties 417

C.7.47 Section 9.10 Text direction: the 'direction' and 'unicode-bidi' proper-
ties 418

C.7.48 Section 9.10 Text direction: the 'direction' and 'unicode-bidi' proper-
ties 418

C.7.49 Section 10.1 Definition of "containing block" 418

C.7.50 Section 10.2 Content width: the 'width' property 419

C.7.51 Section 10.2 Content width: the 'width' property 419

C.7.52 Section 10.2 Content width: the 'width' property 419

C.7.53 Section 10.5 Content height: the 'height' property 419

C.7.54 Section 10.5 Content height: the 'height' property 419

C.7.55 Section 10.6.7 'Auto' heights for block formatting context roots 419

C.7.56 Section 10.7 Minimum and maximum heights: 'min-height' and
'max-height' 420

C.7.57 Section 10.8 Line height calculations: the 'line-height' and 'verti-
cal-align' properties 420

C.7.58 Section 10.8 Line height calculations: the 'line-height' and 'verti-
cal-align' properties 421

C.7.59 Section 10.8.1 Leading and half-leading 421

C.7.60 Section 10.8.1 Leading and half-leading 422

C.7.61 Section 10.8.1 Leading and half-leading 422

C.7.62	Section 11.1	Overflow and clipping	422
C.7.63	Section 11.1.1	Overflow: the 'overflow' property	422
C.7.64	Section 11.1.1	Overflow: the 'overflow' property	423
C.7.65	Section 11.1.1	Overflow: the 'overflow' property	423
C.7.66	Section 11.1.2	Clipping: the 'clip' property	423
C.7.67	Section 12.5	Lists	423
C.7.68	Section 12.5.1	Lists: the 'list-style-type', 'list-style-image', 'list-style-position', and 'list-style' properties	424
C.7.69	Section 12.5.1	Lists: the 'list-style-type', 'list-style-image', 'list-style-position', and 'list-style' properties	424
C.7.70	Section 12.5.1	Lists: the 'list-style-type', 'list-style-image', 'list-style-position', and 'list-style' properties	424
C.7.71	Section 12.5.1	Lists: the 'list-style-type', 'list-style-image', 'list-style-position', and 'list-style' properties	424
C.7.72	Section 12.5.1	Lists: the 'list-style-type', 'list-style-image', 'list-style-position', and 'list-style' properties	424
C.7.73	Section 13.2	Page boxes: the @page rule	425
C.7.74	Section 13.2.2	Page selectors: selecting left, right, and first pages	425
C.7.75	Section 13.3.2	Breaks inside elements: 'orphans', 'widows'	425
C.7.76	Section 13.3.3	Allowed page breaks	426
C.7.77	Section 15.3	Font family: the 'font-family' property	426
C.7.78	Section 15.3.1	Generic font families	426
C.7.79	Section 15.6	Font boldness: the 'font-weight' property	427
C.7.80	Section 15.6	Font boldness: the 'font-weight' property	427
C.7.81	Section 15.7	Font size: the 'font-size' property	427
C.7.82	Section 16.1	Indentation: the 'text-indent' property	428
C.7.83	Section 16.1	Indentation: the 'text-indent' property	428
C.7.84	Section 16.2	Alignment: the 'text-align' property	428
C.7.85	Section 16.2	Alignment: the 'text-align' property	428
C.7.86	Section 16.3.1	Underlining, overlining, striking, and blinking: the 'text-decoration' property	429
C.7.87	Section 16.3.1	Underlining, overlining, striking, and blinking: the 'text-decoration' property	429
C.7.88	Section 16.4	Letter and word spacing: the 'letter-spacing' and 'word-spacing' properties	430
C.7.89	Section 16.6	White space: the 'white-space' property	430
C.7.90	Section 16.6.1	The 'white-space' processing model	431
C.7.91	Section 16.6.1	The 'white-space' processing model	431
C.7.92	Section 16.6.1	The 'white-space' processing model	431
C.7.93	Section 17.2	The CSS table model	431
C.7.94	Section 17.2.1	Anonymous table objects	431
C.7.95	Section 17.2.1	Anonymous table objects	431
C.7.96	Section 17.4	Tables in the visual formatting model	431
C.7.97	Section 17.4	Tables in the visual formatting model	432

C.7.98 Section 17.5.2.2 Automatic table layout	432
C.7.99 Section 17.5.3 Table height algorithms	433
C.7.100 Section 17.5.4 Horizontal alignment in a column	433
C.7.101 Section B.2 Informative references	433
C.7.102 Section D. Default style sheet for HTML 4	433
C.7.103 Section E.2 Painting order	434
C.7.104 Appendix G Grammar of CSS 2.1	434

This appendix is informative, not normative.

CSS 2.1 is an updated revision of CSS2. The changes between the CSS2 specification (see [CSS2]) and this specification fall into five groups: known errors, [p. 365] typographical errors, clarifications, [p. 373] changes [p. 342] and additions. [p. 341] Typographical errors are not listed here.

In addition, this chapter lists the errata (part 1 [p. 387] and part 2) [p. 405] that were subsequently applied to CSS 2.1 since it became a Candidate Recommendation in July 2007.

This chapter is not a complete list of changes. Minor editorial changes and most changes to examples are also not listed here.

C.1 Additional property values

C.1.1 Section 4.3.6 Colors

New color value: 'orange'

C.1.2 Section 9.2.4 The 'display' property

New 'display' value: 'inline-block'

C.1.3 Section 12.2 The 'content' property

New 'content' values 'none' and 'normal'. (The values 'none' and 'normal' are equivalent in CSS 2.1, but may have different functions in CSS3.)

C.1.4 Section 16.6 White space: the 'white-space' property

New 'white-space' values: 'pre-wrap' and 'pre-line'

C.1.5 Section 18.1 Cursors: the 'cursor' property

New 'cursor' value: 'progress'

C.2 Changes

C.2.1 Section 1.1 CSS 2.1 vs CSS 2

This new section is added to explain the motivation for CSS2.1 and its relation to CSS2.

C.2.2 Section 1.2 Reading the specification

This section (formerly Section 1.1) has been marked non-normative.

C.2.3 Section 1.3 How the specification is organized

This section (formerly Section 1.2) has been marked non-normative.

C.2.4 Section 1.4.2.1 Value

This section (formerly unnumbered under 1.3.2) notes that value types are specified in terms of tokens and that spaces may appear between tokens in values. A note explains that spaces are required between some tokens.

C.2.5 Section 1.4.2.6 Media groups

This section (formerly unnumbered under 1.3.2) now declares the Media line in property definitions to be non-normative.

C.2.6 Section 1.4.2.7 Computed value

A new line is added to each property definition specifying what the computed values are for the property. (This defines what level of computation is done to a property value before inheritance and before certain other calculations.)

C.2.7 Section 1.4.4 Notes and examples

This section (formerly 1.3.4) now specifies that HTML examples lacking DOCTYPE declarations are SGML Text Entities conforming to the HTML 4.01 Strict DTD [HTML4]. The markup for many examples has been reformulated to either include a DOCTYPE or conform to this definition.

C.2.8 Section 1.5 Acknowledgments

This section (formerly 1.4) has been updated to reflect contributions to CSS2.1 and has been marked non-normative.

C.2.9 Section 3.2 Conformance

Support for user style sheets is now required (in most cases), rather than just recommended.

Support for turning of author style sheets is now required.

Application of CSS properties to form controls is explicitly undefined. Authors are recommended to treat form control styling capabilities in UAs as experimental.

C.2.10 Section 3.3 Error Conditions

This section changed to say that error handling *is* specified in most cases.

C.2.11 Section 4.1.1 Tokenization

Added INVALID token and rules for its definition.

An optional hyphen, "-", is now allowed at the beginning of an "ident" for vendor extensions. (See section 4.1.2.1)

The underscore character ("_") is allowed in identifiers. The definitions of the lexical macros "nmstart" and "nmchar" now include it. See also section 4.1.2.1 (Vendor extensions).

The "escape" macro has been modified to allow the escaping of any character except newlines, form feeds, and hex digits (to avoid conflict with Unicode escapes).

Modified "string1" and "string2" macros by defining allowed characters through excluding disallowed characters. This allows invisible ASCII characters to be included in a string.

C.2.12 Section 4.1.3 Characters and case

Updated prose about identifiers (second bullet point) to match changes in the tokenization (above).

Excluded null (0x0) character from CSS numerical escapes and indicate that it is undefined in CSS2.1 what happens if such a character is encountered.

Allowed the use of U+FFFD as a replacement for characters outside the range allowed by Unicode.

CSS is no longer case-insensitive, but case-sensitive with exceptions. Changed "All CSS style sheets are case-insensitive, except for parts that are not under the control of CSS" to "All CSS syntax is case-insensitive within the ASCII range (i.e., [a-z] and [A-Z] are equivalent), except for parts that are not under the control of CSS." See also the change to case-sensitivity of counters in 4.3.5. [p. 344]

C.2.13 Section 4.2 Rules for handling parsing errors

Defined parsing in the cases of Malformed Declarations, Unexpected End of Stylesheet, and Unexpected End of String.

C.2.14 Section 4.3 Values

Sections 4.3.7 (Angles), 4.3.8 (Times), and 4.3.9 (Frequencies) have been moved to the informative Appendix A.

C.2.15 Section 4.3.2 Lengths

Added a paragraph on heuristics for finding the x-height of a font.

C.2.16 Section 4.3.4 URLs and URIs

Updated URI references to RFC3986.

C.2.17 Section 4.3.5 Counters

Changed "Counters are denoted by identifiers" to "Counters are denoted by case-sensitive identifiers" (see also the change to case-sensitivity in 4.1.3 [p. 343]).

C.2.18 Section 4.3.6 Colors

Defined the numeric values corresponding to color keywords instead of referencing HTML4 for those values.

UAs are now allowed to intelligently map colors outside the gamut into the gamut instead of simply clipping them into the range of the gamut.

C.2.19 Section 4.3.8 Unsupported Values

Added this section to recommend that unsupported properties and values be ignored as if they were invalid.

C.2.20 Section 4.4 CSS style sheet representation

Changed character encoding detection rule 2 to include a BOM and referred to additional rules below.

Added rule 4 to provide for use of the referring style sheet or document's character encoding.

Added rule 5 to require falling back to UTF-8.

Removed the restriction on using @charset in embedded style sheets.

Allowed a BOM to precede the @charset rule.

Added requirement that @charset rule must be a literal '@charset"...";', not a CSS-syntax equivalent.

Added requirement to support for UTF-8 at minimum.

Specified that any @charset rule not at the beginning of the style sheet must be ignored.

Removed note on theoretical problem with @charset problem and precisely defined rules for character encoding detection based on @charset and/or BOM.

Specified that UAs must ignore style sheets in unknown encodings.

C.2.21 Section 5.8.1 Matching attributes and attribute values

BCP 47 replaces RFC 1766.

C.2.22 Section 5.8.3 Class selectors

Class selectors are allowed for other formats than HTML.

Added a note about matching classes in formats with multiple class attributes per element. The behavior is non-normative, because, at the time of writing, there exist no such formats.

C.2.23 Section 5.9 ID selectors

Specified how to match elements with two or more ID attributes.

C.2.24 Section 5.10 Pseudo-elements and pseudo-classes

Removed exception for HTML UAs that allowed them (and only them) to ignore ':first-letter' and ':first-line'.

C.2.25 Section 5.11.2 The link pseudo-classes: :link and :visited

UAs may return a :visited link to :link status at some point. (This was previously a note, but is now normative.)

Added a note about privacy concerns with link pseudo classes and allowed UAs to treat :visited as :link.

C.2.26 Section 5.11.4 The language pseudo-class: :lang

The identifier C in ':lang(C)' need not be a valid language code, but it must not be empty.

C.2.27 Section 5.12.1 The :first-line pseudo-element

'first-line' also applies to inline blocks, table captions and table cells. Added a definition of "first formatted line" to make the rules about which line is the first line more precise.

UAs are no longer forbidden from applying more properties than the given list.

C.2.28 Section 5.12.2 The :first-letter pseudo-element

More precise definition of first letter. Added rules for cases where the first letter is in an inline block or table cell. Added rules for cases when preceding punctuation is in a different element from the first letter itself.

UAs may apply other properties to first letters than the given list.

Unicode character classes Pi and Pf added to the definition of punctuation.

C.2.29 Section 6.1 Specified, computed, and actual values

Redefined "computed value" and created the concept of "used value" so that inheritance can be performed without laying out the document. This change has the effect of allowing (requiring) percentages to be inherited as percentages and affects many other layout calculations throughout the spec.

Since computed value of a property can now also be a percentage. In particular, the following properties now inherit the percentage if the specified value is a percentage:

- background-position
- bottom, left, right, top
- height, width
- margin-bottom, margin-left, margin-right, margin-top,
- min-height, min-width
- padding-bottom, padding-left, padding-right, padding-top
- text-indent

Note that only 'text-indent' inherits by default, the others only inherit if the 'inherit' keyword is specified.

C.2.30 Section 6.4.1 Cascading order

Changed suggestion that user be able to turn off author styles to a requirement.

C.2.31 Section 6.4.3 Calculating a selector's specificity

The "style" attribute now has a higher specificity than any style rule.

Pseudo-elements are now counted with elements in calculating a selector's specificity.

C.2.32 Section 6.4.4 Precedence of non-CSS presentational hints

"Non-CSS presentational hints" no longer exist, with the exception of a small set of attributes in HTML.

C.2.33 Section 7.3 Recognized Media Types

Added 'speech' media type.

Marked "Media" field in property descriptions informative.

C.2.34 Section 7.3.1 Media Groups

Marked this section informative.

Added sound to 'handheld' in media type/media group table.

Changed 'tactile' to be both 'static' and 'interactive'.

C.2.35 Section 8.3 Margin properties

If the containing block's width depends on an element with percentage margins, then the resulting layout is undefined in CSS 2.1.

C.2.36 Section 8.3.1 Collapsing margins

In the definition of "collapsing margins", added "non-empty content" and "clearance" to the parenthetical list of things that prevent consecutive margins from being adjoining.

Vertical margins of elements with 'overflow' other than 'visible' no longer collapse with their in-flow children.

Defined how margins collapse through an element with adjoining top and bottom margins.

Added that margins of the root element's box do not collapse.

More rigorously defined "adjoining" for margin collapsing [p. 118].

Sixth bullet, second sub-bullet: to find the position of the top border edge, assume the element has a *bottom* (rather than top) border.

Margins of relatively positioned elements *do* sometimes collapse.

C.2.37 Section 8.4 Padding properties

If the containing block's width depends on an element with percentage padding, then the resulting layout is undefined in CSS 2.1.

C.2.38 Section 8.5.2 Border color

'transparent' can now be specified independently for each border side, on par with <color>.

C.2.39 Section 8.5.3 Border style

3D border styles ('groove', 'ridge', 'inset', 'outset') now depend on the corresponding border-color rather than on 'color'.

C.2.40 Section 8.6 The box model for inline elements in bidirectional context

Added this new section to specify layout of inline boxes when affected by bidi.

C.2.41 Section 9.1.2 Containing blocks

Removed paragraphs about the initial containing block, as this is now defined differently. (See changes to section 10.1 [p. 351] .)

C.2.42 Section 9.2.1.1 Anonymous block boxes

Added a paragraph to define formatting when an inline box contains a block box.

Specified what property values are applied to anonymous boxes.

C.2.43 Section 9.2.2.1 Anonymous inline boxes

Specified that collapsed white space does not generate anonymous inline boxes.

C.2.44 Section 9.2.3 Run-in boxes

Changed run-in rules so that a) run-ins that contain blocks become blocks b) run-ins can only run into sibling blocks and c) run-ins cannot run into other run-ins.

C.2.45 Section 9.2.4 The 'display' property

The 'marker' and 'compact' values of the 'display' property are not part of CSS 2.1. Text relating to these values has been removed throughout the specification.

Defined the computed value of 'display' as the specified value except for positioned and floating elements and for the root element. The computed value of 'display' for these elements is defined in section 9.7 [p. 154] and is slightly different from the definition in CSS2.

Conforming HTML UAs are no longer allowed to ignore the 'display' property.

C.2.46 Section 9.3.1 Choosing a positioning scheme

The 'position' property now applies to all elements, including generated content.

The effect of relative positioning on table captions and internal table elements is undefined in CSS 2.1.

For fixed positioning, introduced a conflict between this section and section 10.1 rule 3. See howcome [p. ??] for rationale.

Forbid UAs from paginating the content of fixed boxes.

UAs are allowed to treat all values of 'position' as 'static' on the root element.

C.2.47 Section 9.3.2 Box offsets

Defined computed values of 'top', 'right', 'bottom', 'left' based on the value of 'position'.

Percentage offsets are no longer undefined for containing blocks without an explicit height.

C.2.48 Section 9.4.1 Block formatting contexts

Specified that floats, absolutely positioned elements, inline-blocks, table-cells, table-captions, and elements with 'overflow' other than 'visible' establish new block formatting contexts.

In the paragraph about the position of a box's outer edge with respect to its containing block, except boxes that establish a new block formatting context, as they may become narrower due to floats.

C.2.49 Section 9.4.2 Inline formatting context

Specified that the effect of 'justify' on the content of a line box does not affect the contents of inline-table and inline-block boxes.

Empty line boxes are now required to be treated as zero-height and ignored in margin collapsing.

C.2.50 Section 9.4.3 Relative positioning

Added several paragraphs and an example to explain exactly what the computed values of relatively-positioned offsets are, how they affect each other, and what happens when the positioning is overconstrained. (These were not previously defined.)

C.2.51 Section 9.5 Floats

Floats are no longer required to have an explicit width.

Floats outside of line boxes no longer align to the bottom of the preceding block box; it is implied that they are initially aligned with their non-floated position.

Specified that "If a shortened line box is too small to contain any further content, then it is shifted downward until either it fits or there are no more floats present."

Specified that the border box of a table, block-level replaced element, or element in the normal flow that establishes a new block formatting context must not overlap any floats in the same block formatting context.

C.2.52 Section 9.5.1 Positioning the float

The 'float' property now also applies to :before/:after and generated content.

UAs are now allowed to treat all values of float as 'none' on the root element.

Added to rule 4 prose to define the position of a float when it occurs between two collapsing margins.

C.2.53 Section 9.5.2 Controlling flow next to floats

Defined *clearance* to precisely detail the 'clear' property's effect on margin collapsing and the block's cleared position.

Added note to explain effect of 'clear' on inline elements since CSS1 (but not CSS2 or CSS 2.1) allows 'clear' on inline elements.

C.2.54 Section 9.7 Relationships between 'display', 'position', and 'float'

Changed rules to convert 'display' not always to 'block', but to an appropriate block-level display value as given by a mapping table.

Added rule 4 to convert root element's 'display' value according to the mapping.

C.2.55 Section 9.9 Layered presentation

Specified that the background and borders of an element that forms a stacking context are behind all of its descendants, altered stacking context prose to be more precise, and added a normative Appendix E: Elaborate description of Stacking Contexts [p. 437] to be even more precise about the position of borders, backgrounds, and content on the z-axis.

C.2.56 Section 9.10 Text direction

Conforming UAs are now allowed to not support bidirectional text; in this case they must ignore the 'direction' and 'unicode-bidi' properties. However since applying bidi can have an effect even when a document does not contain right-to-left characters, UAs that do support bidi are no longer permitted to not apply the algorithm just because the document lacks right-to-left characters.

Added a paragraph to define precisely how the Unicode bidirectional algorithm applies to text in the CSS formatting model and how the CSS 'direction' property on blocks maps into the algorithm.

Conforming HTML UAs are no longer exempt from supporting 'direction' and 'unicode-bidi'.

C.2.57 Chapter 10 Visual formatting model details

Updated prose to use the terms "specified", "computed" and "used" as appropriate when referencing values. This affects many calculations in this section. (See changes to section 6.1 [p. 346] .)

C.2.58 Section 10.1 Definition of "containing block"

In rule 1, defined the initial containing block as the viewport for continuous media and the page area for paged media. (It was previously undefined.)

In rule 2, defined the page area as the containing block for fixed positioned elements in paged media.

In rule 4.1, when the containing block of an absolutely-positioned element is formed by an inline-level element, it is now formed by that element's padding edges, not its content edges.

In rule 4, changed the containing block for absolutely positioned elements with only statically positioned elements from the root's content box to the initial containing block.

Specified the positioning and breaking behavior of absolutely-positioned elements in paged media.

C.2.59 Section 10.2 Content width

Declared that if the containing block's width depends on an element's percentage width, then the resulting layout is undefined in CSS 2.1.

C.2.60 Section 10.3 Calculating widths and margins

The computed values of 'left' and 'right' for are now defined in section 9.3.2 [p. 136] . The value 'auto' does not always compute to zero.

Added sections 10.3.9 and 10.3.10 to define calculations for inline blocks.

C.2.61 Section 10.3.2 Inline, replaced elements

The sizing algorithm for replaced elements now takes into account and attempts to preserve the replaced content's intrinsic ratio. Sizing of replaced elements with percentage intrinsic sizes and without intrinsic sizes is now also defined.

The effect of percentage intrinsic widths is now undefined for CSS level 2, rather than ignored.

C.2.62 Section 10.3.3 Block-level, non-replaced elements in normal flow

Specified that a computed total of the width, padding, and borders that is greater than the containing block width causes auto margins to be treated as zero in the rest of the rules. This avoids 'auto' margins being negative on the start edge.

C.2.63 Section 10.3.4 Block-level, replaced elements in normal flow

Applied changes to section 10.3.2 and section 10.3.3 to block-level replaced elements in normal flow by referring to the calculations in those sections.

C.2.64 Section 10.3.5 Floating, non-replaced elements

Defined computations for 'auto' width floats as shrink-to-fit. (Floats were previously required to have fixed widths.)

C.2.65 Section 10.3.6 Floating, replaced elements

Applied changes to section 10.3.2 to this section by referencing it for 'auto' width calculations.

C.2.66 Section 10.3.7 Absolutely positioned, non-replaced elements

Defined the static position of an element more precisely.

Rewrote constraint rules.

The 'direction' property of the containing block of the static position determines which side is clamped to the static position, not the 'direction' property of the containing block of the absolutely positioned element.

C.2.67 Section 10.3.8 Absolutely positioned, replaced elements

In rule 1, applied sizing rules from section 10.3.2.

In rule 2 (formerly rules 2 and 3), referred to new definition of 'static position' in section 10.3.7.

Also in rule 2, the 'direction' property of the containing block of the static position determines which side is clamped to the static position, not the 'direction' property of the containing block of the absolutely positioned element.

In rule 4 (formerly rule 5), prevented 'auto' left and right margins in resulting in a negative margin on the start edge.

C.2.68 Section 10.4 Minimum and maximum widths

Specified that if the containing block's width is negative, the used value of a percentage min/max width is zero.

Specified that if the min/max width is specified in percentages and the containing block's width depends on this element's width, then the resulting layout is undefined in CSS 2.1.

The UA is no longer allowed to select an arbitrary minimum width.

The used width of replaced elements with an intrinsic ratio and both 'width' and 'height' specified as 'auto' is now calculated according to a table designed to preserve the intrinsic ratio as much as possible within the given constraints.

C.2.69 Section 10.5 Content height

Removed mention of 'line-height' for inline elements since their content box height no longer depends on 'line-height'.

Percentage heights on absolutely-positioned elements are no longer treated as 'auto' when the containing block's height is not explicitly specified. Added a note to explain why this is possible.

Specified that a percentage height on the root element is relative to the initial containing block.

C.2.70 Section 10.6 Calculating heights and margins

The computed values of 'top' and 'bottom' for are now defined in section 9.3.2 [p. 136] . The value 'auto' does not always compute to zero.

Added section 10.6.6 to cover cases that are no longer covered under the previous sections.

Added section 10.6.7 to define 'auto' heights for block formatting context roots. (Unlike other block boxes, the height of these boxes increases to accommodate any normal-flow descendant floats.)

C.2.71 Section 10.6.1 Inline, non-replaced elements

The height of an inline box is no longer given by the 'line-height' property and is now undefined. This section now suggests that the height of the box can be based on the font.

C.2.72 Section 10.6.2 Inline replaced elements, block-level replaced elements in normal flow, 'inline-block' replaced elements in normal flow and floating replaced elements

The sizing algorithm for replaced elements now takes into account and attempts to preserve the replaced content's intrinsic ratio. Sizing of replaced elements with percentage intrinsic sizes and without intrinsic sizes is now also defined.

Specified that for inline elements, the margin box is used when calculating the height of the line box.

C.2.73 Section 10.6.3 Block-level non-replaced elements in normal flow when 'overflow' computes to 'visible'

This section now only applies to elements whose 'overflow' value computes to 'visible'; elements with other values of 'overflow' are discussed in the new section 10.6.7 ('Auto' heights for block formatting context roots).

C.2.74 Section 10.6.4 Absolutely positioned, non-replaced elements

Defined the static position of an element more precisely.

Rewrote constraint rules.

C.2.75 Section 10.6.5 Absolutely positioned, replaced elements

In rule 1, applied sizing rules from section 10.6.2.

C.2.76 Section 10.7 Minimum and maximum heights

Percentage min/max heights on absolutely-positioned elements are no longer treated as '0'/none' when the containing block's height is not explicitly specified. However if the containing block's width depends on an element's percentage width, then the resulting layout is undefined in CSS 2.1.

The used width of replaced elements with an intrinsic ratio and both 'width' and 'height' specified as 'auto' is now calculated according to a table designed to preserve the intrinsic ratio as much as possible within the given constraints.

C.2.77 Section 10.8 Line height calculations

Added rule 4 to specify that the height of the line box must be at least as much as that specified by the 'line-height' property on the this block.

C.2.78 Section 10.8.1 Leading and half-leading

UAs are no longer permitted to clip content to the line box, and are instead asked to render overlapping boxes in document order.

'line-height' set on a block no longer specifies the minimal height of each inline box; instead it specifies the minimal height of each line box. The exact effect of this requirement is expressed in terms of struts; it is affected by vertical-alignment.

Adjusted text to reflect that the content box height of an inline is no longer dictated by the 'line-height' property.

Since the content box is now defined by the font and not by the line-height, 'text-top' and 'text-bottom' refer to the content area instead of the font.

Defined 'top' and 'bottom' alignment in terms of aligned subtrees to take into account any protruding descendants.

Defined the baseline of inline tables and inline blocks.

C.2.79 Section 11.1 Overflow and clipping

Specified that 'overflow' clips to the padding edge.

C.2.80 Section 11.1.1 Overflow

'projection' media are no longer permitted to print overflowing content for 'overflow: scroll'. 'print' media now *may*, as opposed to *should*.

UAs are now required to apply the 'overflow' property set on the root element to the viewport. Additionally, HTML UAs must use the 'overflow' property on the HTML BODY element instead if the root element's 'overflow' value is 'visible'.

Specified placement of scrollbar in the box model.

The width of any scrollbars is no longer included in the width of the containing block. (And consequently, all text in section 10.3 that subtracts the scrollbar width from the containing block width has been removed.)

C.2.81 Section 11.1.2 Clipping: the 'clip' property

The 'clip' property now applies only to absolutely positioned elements. Furthermore, it applies to those elements even when their 'overflow' is 'visible'.

The default value of 'clip', 'auto', now indicates no clipping rather than clipping to the element's border box.

Values of "rect()" should be separated by commas. UAs are required to support this syntax, but may also support a space-separated syntax since CSS2 was not clear about this.

While CSS2 specified that values of "rect()" give offsets from the respective sides of the box, current implementations interpret values with respect to the top and left edges for *all* four values (top, right, bottom, and left). This is now the specified interpretation.

C.2.82 Section 11.2 Visibility

The 'visibility' property is now defined to inherit, and descendant elements can override an ancestor's hidden visibility.

C.2.83 Chapter 12 Generated content, automatic numbering, and lists

Moved all discussion of aural rendering to Appendix A.

C.2.84 Section 12.1 The :before and :after pseudo-elements

Removed restrictions on which properties and property values are allowed on ':before' and ':after' pseudo-elements.

C.2.85 Section 12.2 The 'content' property

The initial value of 'content' is now 'normal', not the empty string.

The 'content' property now distinguishes between the empty string, which creates an empty box; and 'normal'/'none', which create no box at all. (There is no distinction between 'normal' and 'none' in level 2.)

A UA is now allowed to report a URI that fails to download.

Removed recommendation to authors to put rules with media-sensitive 'content' properties inside '@media'.

Whether '\A' escapes in generated content create line breaks is now subject to the 'white-space' property.

The former section 12.3 on interaction between ':before', ':after' and elements with 'display: compact' or 'display: run-in' has been removed. (The interaction is already fully defined, because generated content consists of boxes in the tree, no different from other boxes.)

C.2.86 Section 12.3.2 Inserting quotes with the 'content' property

Specified that extra 'close-quote's and 'no-close-quote's (those without a matching 'open-quote' or 'no-open-quote') are not rendered, and that neither 'close-quote' nor 'no-close-quote' cause the quoting depth to be negative.

C.2.87 Section 12.4 Automatic counters and numbering

Defined what a rule with duplicate counters, such as 'counter-reset: section 2 section', means.

C.2.88 Section 12.4.1 Nested counters and scope

The scope of a counter no longer defaults to the whole document, but starts at the first element that uses the counter. (This affects counters that are used without a prior 'counter-reset' to set the scope explicitly.)

C.2.89 Section 12.5 Lists

Removed text in section 12.5 (formerly 12.6) relating to the 'marker' display value.

Removed the 'marker-offset' property (and thus former section 12.6.1).

C.2.90 Section 12.5.1 Lists

The list styles 'hebrew', 'armenian', 'georgian', 'cjk-ideographic', 'hiragana', 'katakana', 'hiragana-iroha' and 'katakana-iroha' have been removed due to lack of implementation experience. (They are expected to return in the CSS3 Lists module.)

Removed the sentence that said that an unknown value for 'list-style-type' should cause the value 'decimal' to be used instead. Instead, normal parsing rules apply and cause the rule to be ignored.

The size of list style markers without an intrinsic size is now defined.

C.2.91 Chapter 13 Paged media

The 'size', 'marks', and 'page' properties are not part of CSS 2.1.

C.2.92 Section 13.2.2 Page selectors

The requirement for UA's to honor different declarations for :left, :right, and :first pages has been softened to simplify implementations: the page area of the :first page may be used for :left and :right pages as well.

C.2.93 Section 13.3.1 Page break properties

UAs are now only required to apply the page break properties to block-level elements in the normal flow of the root element, not to other blocks. However, UAs are now permitted to apply these properties to elements other than block-level elements.

Defined treatment of margins, borders, and padding when a page break splits a box.

The 'page-break-inside' property no longer inherits.

C.2.94 Section 13.3.3 Allowed page breaks

The 'page-break-inside' property of all ancestors is checked for page-breaking restrictions, not just that of the breakpoint's parent.

When dropping restrictions to find a page breaking opportunity, rule A is dropped together with B and D rather than together with C.

Removed restriction on breaking within absolutely positioned boxes.

C.2.95 Section 14.2.1 Background properties

For 'background-position', the restriction that keywords cannot be combined with percentage or length values is removed. I.e., a value like: '25% top' is now allowed. Also, 'background-position' now applies to all elements, not just to block-level and replaced elements.

User agents are no longer allowed to treat a value of 'fixed' for 'background-attachment' as 'scroll'. Instead they must ignore all such declarations as if 'fixed' were an invalid value.

The size of background images without an intrinsic size is now defined.

C.2.96 Section 14.3 Gamma correction

The contents of this section is now a non-normative note.

C.2.97 Chapter 15 Fonts

The 'font-stretch' and 'font-size-adjust' properties have been removed in CSS 2.1.

Font descriptors, the '@font-face' declaration, and all associated parts of the font matching algorithm have been removed in CSS 2.1.

C.2.98 Section 15.2 Font matching algorithm

In this section (previously 15.5), in step 5 (previously 8) of the font matching algorithm, the UA is now allowed to use multiple default fallback fonts to find a glyph for a given character.

In the per-property rule 2, specified that if there is only a small-caps font in a given family, then that font will be selected by 'normal'.

C.2.99 Section 15.2.2 Font family

The "missing character" glyph is no longer considered a match for the last font in a font set, but is now considered a match for U+FFFD.

Certain punctuation characters when appearing in unquoted font family names are now required to be escaped.

C.2.100 Section 15.5 Small-caps

The 'font-variant' property's effect is no longer restricted to bicameral scripts.

C.2.101 Section 15.6 Font boldness

The computed value of 'font-weight' has been defined more precisely such that the 'bolder' and 'lighter' values have an appropriate effect when inheriting through elements with different font-families.

C.2.102 Section 15.7 Font size

Removed suggestion of 1.2 fixed ratio between keyword font sizes in favor of notes recommending a variable ratio and a smallest font-size no less than 9 pixels per EM unit.

Added table mapping CSS font-size keywords to HTML font size numbers.

C.2.103 Chapter 16 Text

The 'text-shadow' property is not in CSS 2.1.

C.2.104 Section 16.2 Alignment

The initial value of 'text-align' is no longer UA-defined but a nameless value that acts as 'left' if 'direction' is 'ltr', 'right' if 'direction' is 'rtl'.

The <string> value for 'text-align' is not part of CSS 2.1.

For 'text-align', specified that 'justify' is treated as the initial value when computed value of 'white-space' is 'pre' or 'pre-line'.

C.2.105 Section 16.3.1 Underlining, over lining, striking, and blinking

More precisely defined what boxes are affected by text decorations specified on a given element.

Specified that underlines, overlines, and line-throughs apply only to text.

Specified that an underline, overline, or line-through applied across a line must be at a constant vertical position and with a constant thickness across the entire line.

Specified how text decorations are affected by relative positioning on descendants.

User agents are now allowed to recognize the 'blink' value but not blink, whereas before they were required to ignore the 'blink' value if they chose not to support blinking text.

Added text to allow older UAs to conform to this section if they follow CSS2's 'text-decoration' requirements but not the additional requirements in CSS2.1.

C.2.106 Section 16.4 Letter and word spacing

Support for the various values of 'letter-spacing' and 'word-spacing' is no longer optional.

Specified that word spacing affects each space, non-breaking space, and ideographic space left in the text after white space processing rules have been applied.

C.2.107 Section 16.5 Capitalization

UAs are no longer allowed to not transform characters for which there is an appropriate transformation but which are outside of Latin-1.

C.2.108 Section 16.6 White space

The 'white-space' property now applies to all elements, not just to block-level elements.

"A" in generated content no longer forces a break for 'normal' and 'nowrap' values of 'white-space'.

Specified that the CSS white space processing model assumes all newlines have been normalized to line feeds.

Added section 16.6.1 [p. 265] to precisely define white space handling.

Added section 16.6.3 [p. 267] to specify handling of control and combining characters.

C.2.109 Chapter 17 Tables

Moved all discussion of aural rendering and related properties to Appendix A.

Updated prose to use the terms "specified", "computed" and "used" as appropriate when referencing values. (See changes to section 6.1 [p. 346] .)

C.2.110 Section 17.2 The CSS table model

Defined handling of multiple 'table-header-group' and 'table-footer-group' elements.

UAs are no longer allowed to ignore the table display values on arbitrary HTML elements, only on HTML table elements.

C.2.111 Section 17.2.1 Anonymous table objects

Changed rules so that internal table elements without an enclosing 'table' or 'inline-table' box generate an anonymous 'inline-table' rather than an anonymous 'table' when inside a "display: inline" parent element.

The anonymous table object rules now treat anonymous boxes as equal to elements' boxes. Replaced several instances of the term "element" with "box", removed several instances of "(in the document tree)" and clarified that anonymous boxes generated in earlier rules are part of the input to later rules. Also replaced the term "object" with "box", as is used throughout the rest of the specification.

HTML UAs are no longer exempt from the anonymous box generation rules.

C.2.112 Section 17.4 Tables in the visual formatting model

The relationship of the caption box, table box, and outer anonymous table box has been changed as follows:

- The margins of the table box now apply to the outer (anonymous) table box that encloses both the table box and the caption(s), not to the inner table box.
- The width of the anonymous box is now equal to the border-box width of the table box inside it instead of adapting to the widths and positions of both the table box and its captions.

C.2.113 Section 17.4.1 Caption position and alignment

The 'left' and 'right' values on 'caption-side' have been removed.

C.2.114 Section 17.5 Visual layout of table contents

Changed rule 5 in grid layout rules to allow overlapping of table cells instead of leaving skipping a gap in the grid to avoid overlap.

C.2.115 Section 17.5.1 Table layers and transparency

In point 6, changed 'These "empty" cells are transparent' to:

If the value of their 'empty-cells' property is 'hide' these "empty" cells are transparent through the cell, row, row group, column, and column group backgrounds, letting the table background show through.

C.2.116 Section 17.5.2.1 Fixed table layout

Specified that in fixed table layout, extra columns in rows after the first must not be rendered.

C.2.117 Section 17.5.2.2 Automatic table layout

Restricted inputs to the table layout algorithm for 'table-layout: auto', whether or not the algorithm described in this section is used, to the width of the containing block and the content of, and any CSS properties set on, the table and any of its descendants.

Added rule 4 to include the column group's width in the algorithm for determining column widths.

C.2.118 Section 17.5.3 Table height algorithms

The 'height' property on tables is now treated as a minimum height; the UA no longer has the option of using 'height' to constrain the size of the table to be smaller than its contents.

The baseline of a cell is now defined much more precisely.

Defined the baseline of a row with no baseline-aligned cells.

C.2.119 Section 17.5.4 Horizontal alignment in a column

The <string> value for 'text-align' is not part of CSS 2.1.

C.2.120 Section 17.6 Borders

Several popular browsers assume an initial value for 'border-collapse' of 'separate' rather than 'collapse' or exhibit behavior that is close to that value, even if they do not actually implement the CSS table model. 'Separate' is now the initial value.

C.2.121 Section 17.6.1 The separated borders model

Specified the effect of padding on the table element.

Specified which parts of the table are included in the width measurement.

C.2.122 Section 17.6.1.1 Borders and Backgrounds around empty cells

Refined definition of "empty" when used as a condition for the 'empty-cells' property so that it is not triggered when the cell includes any child elements, even if they are empty.

The 'empty-cells' property now hides both borders and backgrounds, not just borders.

Changed behavior of a row when it collapses due to 'empty-cells': it is no longer treated as "display: none". Instead it is given zero height and its associated border-spacing is eliminated.

C.2.123 Section 17.6.2 The collapsing border model

The outer half of the table borders no longer lie in the margin area. Specified which part of the table is considered the border area in the collapsed borders model and how its width is calculated. The edges of the box in which the table background is painted is, however left explicitly undefined.

C.2.124 Section 17.6.2.1 Border conflict resolution

Defined in rule 4 what happens when two elements of the same type conflict and their borders have the same width and style.

C.2.125 Section 18.1 Cursors: the 'cursor' property

The size of cursors without an intrinsic size is now defined.

C.2.126 Section 18.4 Dynamic outlines

Position of outline with respect to the border edge is now only suggested, not required.

Conformant UAs are now allowed to ignore the 'invert' value. In such UAs the initial value of 'outline-color' is the value of the 'color' property.

C.2.127 Chapter 12 Generated content, automatic numbering, and lists

The 'marker' value for 'display' does not exist in CSS 2.1

C.2.128 Appendix A. Aural style sheets

Chapter 19 on aural style sheets has become appendix A and is not normative in CSS 2.1. Related units (deg, grad, rad, ms, s, Hz, kHz) are also moved to this appendix, as is the 'speak-header' property from the "tables" chapter and other notes on aural table rendering. The 'aural' media type is deprecated in favor of the new 'speech' media type.

C.2.129 Appendix A Section 5 Pause properties

Changed the initial value of 'pause-before' and 'pause-after' to be 0 instead of UA-defined.

A note has been added to this section (formerly 19.4) about the change in position and behavior of pauses in CSS3 Speech compared to this appendix.

C.2.130 Appendix A Section 6 Cue properties

This section (formerly Section 19.5) now specifies the placement of cues and pauses with respect to the :before and :after pseudo-elements.

C.2.131 Appendix A Section 7 Mixing properties

The keywords 'mix' and 'repeat' may now appear in either order.

C.2.132 Appendix B Bibliography

Various references in Appendix B (formerly Appendix E) have been updated as appropriate.

- Switched [CSS1] from Normative to Informative.

- Updated URI reference from [RFC1808] and the draft-fielding-uri-syntax-01.txt to [RFC3986].

- Updated HTTP reference from [RFC2068] to [RFC2616].

- Removed normative references to [IANA] and [ICC32].

- Added normative references to [ICC42], [RFC3986], [RFC2070], [UAAG10].

Added informative references to CSS2, CSS3 Color, CSS3 Lists, Selectors, CSS3 Speech, DOM 3 Core, MathML 2, P3P, RFC1630, SVG 1.1, XHTML 1, XML ID, and XML Namespaces.

Removed informative references to [ISO10179] (DSSSL), [INFINIFONT], [ISO9899] (C), [MONOTYPE], [NEGOT], [OPENTYPE], [PANOSE], [PANOSE2], [POSTSCRIPT], [RFC1866] (HTML 2), [RFC1942] (HTML Tables), [TRUETYPEGX], [W3CStyle].

Updated language tags references from [RFC1766] to [BCP47].

C.2.133 Other

The former informative appendix C, "Implementation and performance notes for fonts," is left out of CSS 2.1.

C.3 Errors

C.3.1 Shorthand properties

Shorthand properties take a list of subproperty values *or* the value 'inherit'. One cannot mix 'inherit' with other subproperty values as it would not be possible to specify the subproperty to which 'inherit' applied. The definitions of a number of shorthand properties did not enforce this rule: 'border-top', 'border-right', 'border-bottom', 'border-left', 'border', 'background', 'font', 'list-style', 'cue', and 'outline'.

C.3.2 Applies to

The "applies to" line of many property definitions has been made more accurate by excluding or including table display types where appropriate.

C.3.3 Section 4.1.1 (and G2)

DELIM should not have included single or double quote. Refer also to section 4.1.6 on strings, which must have matching single or double quotes around them.

Removed "A-Z" from the "nmchar" token: as CSS is case insensitive anyway, it was redundant.

Corrected "unicode" macro to treat CRLF as a single character.

Corrected "block" production to allow white space between declarations.

In the rule for "any" (in the core syntax), corrected "FUNCTION" to "FUNCTION any* ')"

C.3.4 Section 4.1.3 Characters and case

Corrected third paragraph to say that an '@import' rule can only be preceded by an '@charset' rule or other '@import' rules.

C.3.5 Section 4.3 (Double sign problem)

Several values described in subsections of this section incorrectly allowed two "+" or "-" signs at their beginnings.

C.3.6 Section 4.3.2 Lengths

Fixed double sign error in definition of <length>. (<number> already has a sign.)

Corrected the suggested reference pixel to be based on a 96 dpi device, not 90 dpi. The visual angle is thus about 0.0213 degrees instead of 0.0227, and a pixel at arm's length is about 0.26 mm instead of 0.28

Corrected last sentence to refer to a unsupported *used* length, not an unsupported specified length.

C.3.7 Section 4.3.3 Percentages

Fixed double sign error in definition of <percentage>. (<number> already has a sign.)

C.3.8 Section 4.3.4 URLs and URIs

Defined escaping requirements in terms of the URI token so that no escaping requirements are missing from the prose.

Included invalid URIs in last paragraph about URI error handling.

C.3.9 Section 4.3.5 Counters

Corrected syntax of counter() and counters() notation to allow white space between tokens.

C.3.10 Section 4.3.6 Colors

Deleted the comments about range restriction after the following examples:

```
em { color: rgb(255,0,0) }
em { color: rgb(100%, 0%, 0%) }
```

C.3.11 Section 4.3.7 Strings

(Formerly section 4.3.10) Corrected text to allow all forms of Unicode escapes for U+000A, not just the "\A" form, for including newlines in strings.

C.3.12 Section 5.10 Pseudo-elements and pseudo-classes

In the second bullet, added that the ':lang()' pseudo-class can also be deduced from the document in some cases.

C.3.13 Section 6.4 The cascade

Removed paragraph about imported style sheets being overridden by rules in the importing style sheet: imported style rules follow the cascade as specified in 6.4.1 Cascading order [p. 103] , exactly as if they were inserted in place of the @import rule.

C.3.14 Section 8.1 Box Dimensions

The definition of "content edge" has been changed to depend on 'width' and 'height' rather than directly on 'rendered content'.

From the definition of "padding edge", deleted the sentence "The padding edge of a box defines the edges of the containing block established by the box." For information about containing blocks, consult Section 10.1 [p. 171] .

C.3.15 Section 8.2 Example of margins, padding, and borders

The colors in the example HTML did not match the colors in the image.

C.3.16 Section 8.5.4 Border shorthand properties

Changed various border shorthands' syntax definitions to use the <border-width>, <border-style> and <'border-top-color'> value types as appropriate.

C.3.17 Section 9.2.1 Block-level elements and block boxes

Excepted table elements from second paragraph about principal block boxes and their contents.

Corrected sentence to say "either only block boxes or only inline boxes" instead of "only block boxes".

C.3.18 Section 9.3.1 Choosing a positioning scheme

In the definition of "position: static", added 'right' and 'bottom' to the sentence saying that 'top' and 'left' do not apply.

C.3.19 Section 9.3.2 Box offsets

The properties 'top', 'right', 'bottom', and 'left', incorrectly referred to offsets with respect to a box's content edge. The proper edge is the margin edge. Thus, for 'top', the description now reads: "This property specifies how far a box's top margin edge is offset below the top edge of the box's containing block."

Corrected text under property definitions to say that for relatively-positioned elements, 'top', 'right', 'bottom', and 'left' define the offset from the box's position in the normal flow, not from the edges of the containing block. (The previous definition conflicted with that was further down; since that text is now redundant, it has been removed.)

C.3.20 Section 9.4.1 Block formatting contexts

In paragraph about relationship of a box's outer edges to its containing block's edges, corrected parenthetical to say that *line boxes*, not the *content area*, may shrink due to floats.

C.3.21 Section 9.4.2 Inline formatting context

Added "and the presence of floats" to "The width of a line box is determined by a containing block".

C.3.22 Section 9.4.3 Relative positioning

In the first paragraph, added "or floated" to the phrase "laid out according to the normal flow" as floated elements can be relatively positioned but are not part of the normal flow.

C.3.23 Section 9.5 Floats

Corrected sentence about not enough horizontal room for the float to say that it is shifted downward until either it fits *or there are no more floats present*.

C.3.24 Section 9.5.1 Positioning the float

Correct "Applies to" line and prose to say that the 'float' property can be set for any element but only applies to elements that are not absolutely positioned.

C.3.25 Section 9.5.2 Controlling flow next to floats

Removed sentence saying that 'clear' may only be specified for block-level elements: it can be specified for any element, it only *applies to* block-level elements.

C.3.26 Section 9.6 Absolute positioning

Corrected sentence that said absolutely positioned boxes establish a new containing block for absolutely positioned descendants to except fixed positioned descendants.

C.3.27 Section 9.7 Relationships between 'display', 'position', and 'float'

In rule 1, corrected "user agents must ignore 'position' and 'float' to "'position' and 'float' do not apply".

C.3.28 Section 9.10 Text direction

Corrected note about 'direction' on table column elements to say that "columns are not the ancestors of the cells in the document tree" rather than saying "columns do not exist in the document tree".

Added table cells, table captions, and inline blocks alongside block-level elements in description of 'bidi-override' value. Also corrected the prose to handle anonymous child blocks.

Updated mention of Unicode's embedding limit from 15 to 61.

C.3.29 Section 10.1 Definition of "containing block"

Included table cells (and inline blocks) together with block-level elements in rule 2 defining the containing block of non-absolutely-positioned elements.

C.3.30 Section 10.3.3 Block-level, non-replaced elements in normal flow

In the last sentence of the paragraph following the equation ("If the value of 'direction' is 'ltr', this happens to 'margin-left' instead") substituted 'rtl' for 'ltr'.

C.3.31 Section 10.4 Minimum and maximum widths

The initial value for 'min-width' is now '0' rather than UA-dependent.

Corrected "applies to" exception for both 'min-width' and 'max-width' from "table elements" to "table rows and row groups".

Specified that negative values for 'min-width' and 'max-width' are illegal.

C.3.32 Section 10.6.3 Block-level non-replaced elements in normal flow when 'overflow' computes to 'visible'

Added that 'auto' height also depends on whether the element has padding or borders, as these influence margin-collapsing behavior.

Added text to correctly account for margin collapsing behavior.

C.3.33 Section 10.7 Minimum and maximum heights

Corrected "applies to" exception for both 'min-width' and 'max-width' from "table elements" to "table columns and column groups".

Specified that negative values for 'min-height' and 'max-height' are illegal.

C.3.34 Section 11.1.1 Overflow

Corrected "applies to" line for 'overflow' from "block-level and replaced elements" to "non-replaced block-level elements, table cells, and inline-block elements".

The example of a DIV element containing a BLOCKQUOTE containing another DIV was not rendered correctly. The first style rule applied to both DIVs, so the second DIV box should have been rendered with a red border as well. The second DIV has now been changed to a CITE, which does not have a red border.

C.3.35 Section 11.1.2 Clipping: the 'clip' property

Corrected "rect (<top> <right> <bottom> <left>)" to "rect(<top>, <right>, <bottom>, <left>)".

C.3.36 Section 11.2 Visibility

Corrected initial value of 'visibility' to 'visible'.

C.3.37 Section 12.4.2 Counter styles

The example used the style 'hebrew', which does not exist in CSS level 2. Changed to 'lower-greek'.

C.3.38 Section 12.6.2 Lists

Under the 'list-style' property, the example:

```
ul > ul { list-style: circle outside } /* Any UL child of a UL */
```

could never match valid HTML markup (since a UL element cannot be a child of another UL element). An LI has been inserted in between.

C.3.39 Section 14.2 The background

Second sentence: "In terms of the box model, 'background' refers to the background of the content and the padding areas" now also mentions the border area. (See also errata to section 8.1 [p. 367] above.) Thus:

In terms of the box model, "background" refers to the background of the content, padding and border areas.

C.3.40 Section 14.2.1 Background properties

Under 'background-image', defined the image tile size used when the background image has intrinsic sizes specified in percentages or no intrinsic size.

Under 'background-repeat', the sentence "All tiling covers the content and padding areas [...]" has been corrected to

"All tiling covers the content, padding and border areas [...]".

Under 'background-attachment', the value 'scroll' is defined to scroll with the "containing block" rather than with the "document". Also the sentence "Even if the image is fixed [...] background or padding area of the element" has been corrected to

Even if the image is fixed, it is still only visible when it is in the background, padding or border area of the element.

C.3.41 Section 15.2 Font matching algorithm

In bullet 2, changed "the UA uses the 'font-family' descriptor" to "the UA uses the 'font-family' property".

C.3.42 Section 15.7 Font size

The statement "Negative values are not allowed" for 'font-size' now applies to percentages as well as lengths.

C.3.43 Section 16.1 Indentation

Corrected 'text-indent' to apply to table cells (and inline blocks) as well as block-level elements.

C.3.44 Section 16.2 Alignment

Corrected 'text-align' to apply to table cells (and inline blocks) as well as block-level elements.

Changed prose about the effect of 'justify' to be less correct.

Corrected the note to say that justification is also dependent on the script, not just the language, of the text.

C.3.45 Section 17.2 The CSS table model

In the definition of **table-header-group**, changed "footer" to "header" in "Print user agents may repeat footer rows on each page spanned by a table."

C.3.46 Section 17.2.1 Anonymous table objects

Added 'table-header-group' and 'table-footer-group' alongside mentions of 'table-row-group' where missing.

Corrected 'caption' to 'table-caption'.

Added missing rule (#3) for 'table-column' boxes.

Added 'table-caption' and 'table-column-group' to list of boxes requiring a 'table' or 'inline-table' parent in rule 4.

Added rules 5 and 6 to generate 'table-row' boxes where necessary for children of 'table'/'inline-table' and 'table-row-group'/'table-header-group'/'table-footer-group' boxes.

C.3.47 Section 17.4 Tables in the visual formatting model

Specified handling of multiple caption boxes.

Specified that the anonymous outer table box is a 'block' box if the table is block-level and an 'inline-block' box if the table is inline-level but that the anonymous outer table box cannot accept run-ins.

C.3.48 Section 17.5 Visual layout of table contents

Correct text that said all internal table elements have padding; change to say that of these only table cells have padding.

The following note:

Note. Table cells may be relatively and absolutely positioned, but this is not recommended: positioning and floating remove a box from the flow, affecting table alignment.

has been amended as follows:

Note. Table cells may be positioned, but this is not recommended: absolute and fixed positioning, as well as floating, remove a box from the flow, affecting table size.

C.3.49 Section 17.5.1 Table layers and transparency

The rows and columns only cover the whole table in the collapsed borders model, not in the separated borders model.

The points 2, 3, 4 and 5 have been corrected to define the area covered by rows, columns, row groups and column groups and thus the positioning and painting of backgrounds on those elements.

Specify the handling of "missing cells".

C.3.50 Section 17.6.1 The separated borders model

In the image, changed "cell-spacing" to "border-spacing".

C.3.51 Section 18.2 System Colors

For the 'ButtonHighlight' value, changed the description from "Dark shadow" to "Highlight color".

C.3.52 Section E.2 Painting order

Changed "but any descendants which actually create a new stacking context" to "but any positioned descendants and descendants which actually create a new stacking context" (3 times).

This change also occurred once in section 9.5 (Floats) [p. 143] and once in section 9.9 (Layered presentation). [p. 164]

C.4 Clarifications

C.4.1 Section 2.1 A brief CSS 2.1 tutorial for HTML

This section has been marked non-normative.

C.4.2 Section 2.2 A brief CSS 2.1 tutorial for XML

This section has been marked non-normative.

Added a statement about case-sensitivity of selectors for XML.

The specification for the XML style sheet PI [p. ??] was written after CSS2 was finalized. The first line of the full XML example should not have been `<?XML:stylesheet type="text/css" href="bach.css" ?>`, but

```
<?xml-stylesheet type="text/css" href="bach.css" ?>
```

C.4.3 Section 2.3 The CSS 2.1 processing model

This section has been marked non-normative.

C.4.4 Section 3.1 Definitions

Added a note to clarify that the deprecated/non-deprecated status of a feature is distinct from its normative/non-normative status.

Under 'document language' clarified that CSS only describes the presentation of a document language, and has no effect on its semantics.

Changed definition of 'replaced element' to "an element whose content is outside the scope of the CSS formatting model" and added further clarifying text. This clarifies that e.g., SVG images embedded in an XML document are also considered replaced elements, not just those linked in from an outside file. Also changed definition of 'rendered content' to be consistent with this clarification.

Added under "Intrinsic dimension" that raster images without reliable resolution information are assumed to have a size of 1 px unit per image source pixel.

Added definition for 'ignore'.

Added definition for 'HTML user agent'.

Added definition for 'property'.

C.4.5 Section 4.1 Syntax

Moved definitions of "immediately before" and "immediately after" forward so they apply to the whole Syntax section.

Added sections 4.1.2.1 and 4.1.2.2 to defined vendor-specific extensions.

C.4.6 Section 4.1.1 Tokenization

Clarified that input that cannot be parsed according to the core syntax is ignored according to the rules for handling parsing errors.

Clarified that input that cannot be tokenized or parsed has no meaning in CSS2.1.

C.4.7 Section 4.1.3 Characters and case

Clarified that when a CRLF pair terminates an escape sequence, the pair is treated as a single white space character as corrected [p. 365] in the tokenization rules.

Replaced "[a-z0-9]" by "[a-zA-Z0-9]" as an extra reminder that CSS identifiers are case-insensitive.

C.4.8 Section 4.1.7 Rule sets, declaration blocks, and selectors

Replaced the term "{}-block" with "declaration block".

C.4.9 Section 4.2 Rules for handling parsing errors

Clarified that all property:value combinations and @-keywords that do not contain an identifier beginning with dash or underscore are reserved by CSS for future use.

Clarified that when something inside an at-rule is ignored because it is invalid, this does not make the entire at-rule invalid.

Referenced section 4.1.7 for parsing invalid bits inside declaration blocks.

C.4.10 Section 4.3.1 Integers and real numbers

Clarified that '-0' is equivalent to '0' and is not a negative number.

C.4.11 Section 4.3.2 Lengths

Clarified that negative length values on properties that do not allow them cause the declaration to be ignored.

C.4.12 Section 4.3.4 URLs and URIs

Reduced unnecessary discussion of what a URI is.

C.4.13 Section 5.1 Pattern matching

Added note about terminology change ("simple selector") between CSS2 and CSS3.

C.4.14 Section 5.7 Adjacent sibling selectors

Clarified that text nodes and comments do not affect whether a sibling selector matches.

C.4.15 Section 5.8.1 Matching attributes and attribute values

Clarified ~ = and | = by using the definitions from the Selectors module.

C.4.16 Section 5.8.2 Default attribute values in DTDs

Clarified that rules about default attribute values are the same, whether the default is specified in a DTD or by other means.

C.4.17 Section 5.9 ID selectors

Added a note that it depends on the document format which attributes are ID attributes.

C.4.18 Section 5.11.3 The dynamic pseudo-classes: `:hover`, `:active`, and `:focus`

Clarified that CSS 2.1 does *not* define if the parent of an element that matches `:active` or `:hover` itself also matches `:active` or `:hover`.

Added note that, in CSS1, `:active` only applies to links.

C.4.19 Section 5.11.4 The language pseudo-class: `:lang`

Added a note to show the differences between `:lang(xx)` and `[lang=xx]`.

C.4.20 Section 5.12.2 The `:first-letter` pseudo-element

Clarified that digits can also be first letter.

C.4.21 Section 6.2 Inheritance

Clarified that computed values are inherited (not specified values) and that they become the specified value on the inheritor.

Removed discussion of "default" styles for a document.

C.4.22 Section 6.2.1 The `'inherit'` value

Clarify that `'inherit'` can be used on properties that are not normally inherited and that when set on the root element, it has the effect of assigning the property's initial value.

C.4.23 Section 6.3 The `@import` rule

Except `@charset` from the statement that `@imports` must precede all other rules.

C.4.24 Section 6.4 The Cascade

Obfuscated note about system settings and UA limitations.

C.4.25 Section 6.4.1 Cascading order

Various editorial changes to clarify sort order.

C.4.26 Section 6.4.3 Calculating a selector's specificity

Added a note:

The specificity is based only on the form of the selector. In particular, a selector of the form "[id=p33]" is counted as an attribute selector (a=0, b=1, c=0), even if the id attribute is defined as an "ID" in the source document's DTD.

C.4.27 Section 7.2.1 The @media rule

Clarify that Style rules outside of @media rules apply to the same media types that the style sheet itself applies to.

C.4.28 Section 7.3 Recognized media types

Added text to clarify that media types are mutually exclusive, but a UA can render simultaneously to canvases with different media types.

C.4.29 Section 7.3.1 Media groups

Split "aural" media group into "audio" and "speech".

C.4.30 Section 8.1 Box dimensions

- The terms "content box", "padding box", "border box", and "margin box" have been defined.
- Border backgrounds are not specified by border properties. Changed the last paragraph of 8.1 to:

The background style of the content, padding, and border areas of a box is specified by the 'background' property of the generating element. Margin backgrounds are always transparent.

- Removed definition of "box width" and "height".

C.4.31 Section 8.3 Margin properties

Added a sentence to note that vertical margins have no effect on non-replaced inline elements.

C.4.32 Section 8.3.1 Collapsing margins

Changed "absolute maximum" to "maximum of the absolute values" in sentence about negative margins collapsing.

Added this clarifying note to the first bullet of the explanation of vertical collapsing of margins:

Note. Adjoining boxes may be generated by elements that are not related as siblings or ancestors.

Emphasized that floating elements' margins do not collapse even between a float and its in-flow children.

Emphasized that absolutely positioned elements' margins do not collapse even between the positioned element and its in-flow children.

C.4.33 Section 8.5.3 Border style

Changed description of 'none' value to not imply that all four border widths are set to zero.

C.4.34 Section 9.1.1 The viewport

Changed the sentence "When the viewport is smaller than the ..., the user agent should offer a scrolling mechanism" to use "area of the canvas on which the document is rendered" instead of "document's initial containing block".

C.4.35 Section 9.2.4 The 'display' property

Clarified that 'display: none' also applies to non-visual media.

C.4.36 Section 9.3.1 Choosing a positioning scheme

Clarified that the margins of fixed positioned boxes do not collapse with any other margins.

Clarified that in print media fixed boxes are rendered on every page.

C.4.37 Section 9.3.2 Box offsets

Clarified that negative lengths and percentages are allowed as values of 'top', 'right', 'bottom', and 'left'.

Added "For replaced elements, the effect of this value depends only on the intrinsic dimensions of the replaced content. See the sections on the width and height of absolutely positioned, replaced elements for details." to the definition of 'auto' because that's not what chapter 10 says at all.

C.4.38 Section 9.4.2 Inline formatting context

Clarified that 'justify' stretches "spaces and words in inline boxes"; previous text simply said that it stretches "inline boxes".

The statement "When an inline box is split, margins, borders, and padding have no visual effect where the split occurs." has been generalized. Margins, borders, and padding have no visual effect where one or more splits occur.

Clarified that an inline box that exceeds the width of a line box and cannot be split therefore overflows the line box.

Removed sentence about formatting of margins, borders, and padding for split inline boxes not being fully defined when affected by bidi as that situation is now defined in section 8.6 [p. 126] .

C.4.39 Section 9.4.3 Relative positioning

Clarified that although relative positioning normally does not directly affect layout, it may affect layout indirectly through the creation of scrollbars.

Relatively positioned boxes do not always establish new containing blocks. Changed the second paragraph to refer to the section on containing blocks accordingly.

The paragraph about dynamic movement and superscripting has been shifted into a non-normative note.

C.4.40 Section 9.5 Floats

Clarified that line boxes are shortened to make room for the *margin box* of the float.

Added some text to clarify what "Any content in the current line before a floated box is reflowed in the first available line on the other side of the float" means.

Clarified floats' position in the stacking order.

C.4.41 Section 9.5.1 Positioning the float

Clarified that the elements referenced in the float behavior rules are in the same block formatting context as the float.

C.4.42 Section 9.5.2 Controlling flow next to floats

Clarified that the effects of 'clear' do not consider floats in other block formatting contexts.

C.4.43 Section 9.8 Comparison of normal flow, floats, and absolute positioning

Added a note to clarify that the images in this section are not drawn to scale and are illustrations, not reference renderings.

C.4.44 Section 10.1 Definition of "containing block"

Noted that a containing block formed by inline elements may wind up with a negative containing block width.

C.4.45 Section 10.2 Content width

In the definition of <length> values for the 'width' property, changed "Specifies a fixed width" to "Specifies the width of the content area using a length unit".

C.4.46 Section 10.3.3 Block-level, non-replaced elements in normal flow

Clarified that setting both left and right margins to 'auto' horizontally centers the element within its containing block.

C.4.47 Section 10.3.8 Absolutely positioning, replaced elements

Clarified which part of the text of section 10.3.7 is re-used.

C.4.48 Section 10.4 Minimum and maximum widths

Clarified that 'min-width' and 'max-width' do not affect the computed values of any properties. (They only affect the used value.)

C.4.49 Section 10.6 Calculating heights and margins

Clarified that these rules apply to the root element just as to any other element.

C.4.50 Section 10.7 Minimum and maximum heights

Clarified that 'min-width' and 'max-width' do not affect the computed values of any properties. (They only affect the used value.)

C.4.51 Section 10.8 Line height calculations

Removed clarifying note about line height being taller than tallest single inline box due to vertical alignment.

C.4.52 Section 10.8.1 Leading and half-leading

Removed "slightly" from the note "Values of this property have slightly different meanings in the context of tables."

C.4.53 Section 11.1 Overflow and clipping

Clarified when absolute positioning and negative margins cause overflow.

Added 'text-indent' to the list of things that can cause overflow.

Removed mention of 'clip' since it no longer affects most elements; mentioned that the 'overflow' property also specifies whether a scrolling mechanism is provided to access clipped content.

C.4.54 Section 11.1.1 Overflow

Clarified that descendant elements whose containing block is the viewport or an ancestor of the element are not affected by overflow clipping.

Removed unnecessary mentions of the 'clip' property from the 'hidden' value definition.

C.4.55 Section 11.1.2 Clipping

Changed "portion of an element's rendered content" to "portion of an element's border box" since clipping also affects the element's backgrounds and borders.

Clarified what parts of the element are affected by clipping.

Clarified that clipped content does not cause overflow.

Clarified that arguments of clip() can be separated by spaces or by commas, *but not a combination*.

C.4.56 Section 11.2 Visibility

Clarified that descendants of a 'visibility: hidden' element will be visible if they have 'visibility: visible'.

C.4.57 Section 12.1 The :before and :after pseudo-elements

Clarified that :before and :after pseudo-elements interact with other boxes as if they were real elements just inside their associated element.

Noted that the interaction of :before and :after with replaced elements is left undefined for now.

C.4.58 Section 12.2 The 'content' property

Clarified which counters are used for counter() and counters() in case there are multiple counters of the same name.

C.4.59 Section 12.3.2 Inserting quotes with the 'content' property

Removed note about common typographic practices when quotes in different languages are mixed.

C.4.60 Section 12.4 Automatic counters and numbering

In the "self-nesting" behavior of counters, clarified that merely using a counter in a child element does not create a new instance of it: only resetting it does.

Clarified that the scope of a counter does not include any elements in the scope of a counter with the same name created by a 'counter-reset' on a later sibling or a later 'counter-reset' on the same element.

Removed sentence about scope of 'counter-increment' without prior 'counter-reset' as that is now defined (differently) under "12.4.1 Nested counters and scope."

C.4.61 Section 12.4.3 Counters in elements with 'display: none'

Clarified that pseudo-elements that generate no boxes also do not increment counters.

C.4.62 Section 14.2 The background

Clarified that the root background image, although painted over the entire canvas, is anchored as if painted only for the root element, and that the root's background is only painted once.

Clarified rules for propagation of background settings on HTML's <body> element to the root.

Added statement about z-index of backgrounds for elements that form a stacking context and referred to z-index property for details.

Added this note after the first paragraph after 'background-attachment':

Note that there is only *one* viewport per document. I.e., even if an element has a scrolling mechanism (see 'overflow'), a 'fixed' background does not move with it.

Definition of 'background-position' has been rewritten as normative rules rather than just examples.

Stated that the tiling and positioning of background images for inline elements is undefined in CSS2.1.

C.4.63 Section 15.1 Fonts Introduction

Drastically shortened introduction.

C.4.64 Section 15.2 Font matching algorithm

In the per-property rule 2, clarified that 'normal' matches the non-small-caps variant (if there is one).

C.4.65 Section 15.2.2 Font family

Removed discussion of font-matching algorithm. (It is already covered in the font-matching algorithm's own section [p. 241] .

Clarified that quoted strings that are the same as a keyword value must be treated as font family names and not as the keyword value (which must be unquoted).

C.4.66 Section 15.3.1 Generic font families

This section, previously section 15.2.6, has been moved but no other change was made.

C.4.67 Section 15.4 Font styling

The text for this section (formerly part of 15.2.3) has been reverted to its CSS1 format.

C.4.68 Section 15.5 Small-caps

The text for this section (formerly part of 15.2.3) has been reverted to its CSS1 format.

Clarified that CSS2.1 cannot select font variants besides small-caps.

Clarified that when "font-variant: small-caps" results in the substitution of full-caps, the behavior is the same as for text-transform.

C.4.69 Section 15.6 Font boldness

The text for this section (formerly part of 15.2.3) has been reverted to its CSS1 format. Also, discussion of font-weight from other parts of the Fonts chapter has been aggregated under this section.

Removed statement that says "User agents must map names to values in a way that preserves visual order; a face mapped to a value must not be lighter than faces mapped to lower values." This is otherwise implied by "The only guarantee is that a face of a given value will be no less dark than the faces of lighter values."

C.4.70 Section 15.7 Font size

Clarified relationship of font size to em squares.

Added a totally irrelevant note about font sizes virtual reality scenes.

C.4.71 Section 16.1 Indentation

Clarified that text overflowing due to text-indent is affected by the 'overflow' property.

Added a note about text-indent inheriting behavior and suggesting 'text-indent: 0' on inline-blocks.

C.4.72 Section 16.2 Alignment

Changed "double justify" to "justify" under "left, right, center, and justify".

C.4.73 Section 16.3.1 Underlining, over lining, striking, and blinking

Added an example to illustrate how underlining affects descendant boxes.

C.4.74 Section 16.5 Capitalization

Switched language reference from RFC2070 to BCP47.

C.4.75 Section 16.6 White space

Added section 16.6.1 [p. 266] as an example to illustrate the interaction of white space collapsing and bidi.

C.4.76 Section 17.1 Introduction to tables

Expanded introduction to include a brief discussion of the two table layout models. Mentioned that the automatic table algorithm is not fully defined in CSS 2.1 but that some implementations have achieved relatively close interoperability.

C.4.77 Section 17.2 The CSS table model

Clarify that all table captions must be rendered if more than one exists.

Specified that replaced elements with table display values are treated as table elements in table layout.

C.4.78 Section 17.2.1 Anonymous table objects

Moved the first bullet text to the prose before the list of generation rules as it is a general statement of what the rules are supposed to accomplish.

C.4.79 Section 17.4 Tables in the visual formatting model

Clarified that "display: table" elements behave as block-level elements and "display: inline-table" elements behave as inline-level elements and not the other way around.

Clarified that 'table-caption' boxes behave as normal block boxes within the outer anonymous table box.

Clarified that percentage 'width' and 'height' on the table box is relative to the anonymous box's containing block, not the anonymous box itself.

Clarified that the 'position', 'float', 'top', 'right', 'bottom', and 'left' values on the table box are used on the anonymous outer box instead of the table box and that the table box itself uses the initial values of those properties.

C.4.80 Section 17.5 Visual layout of table contents

To remove ambiguity about the position of extent of internal table boxes, the following paragraph was added after point 6:

the edges of the rows, columns, row groups and column groups in the collapsing borders model [p. 291] coincide with the hypothetical grid lines on which the borders of the cells are centered. (And thus, in this model, the rows together exactly cover the table, leaving no gaps; ditto for the columns.) In the separated borders model, [p. 288] the edges coincide with the border edges [p. 112] of cells. (And thus, in this model, there may be gaps between the rows and columns, corresponding to the 'border-spacing' property.)

Changed warning note about positioning of table cells to be more precise about the possibly unintended effects.

C.4.81 Section 17.5.1 Table layers and transparency

At the end of the section added the following paragraph:

Note that if the table has 'border-collapse: separate', the background of the area given by the 'border-spacing' property is always the background of the table element. See 17.6.1

C.4.82 Section 17.5.2 Table width algorithms

Added a paragraph to clarify the interaction of the table width algorithms with the rules in section 10.3 [p. 175] (Calculating widths and margins).

C.4.83 Section 17.5.2.1 Fixed table layout

Explicitly mentioned that the fixed table layout algorithm may be used with the algorithm of section 10.3.3 [p. 176] when 'table-layout' is 'fixed' but 'width' is 'auto'.

C.4.84 Section 17.5.2.2 Automatic table layout

Clarified that UAs can use other algorithms besides the one in this section *even if* it results in different behavior. Also marked the rest of the section non-normative in accordance with that statement.

C.4.85 Section 17.5.4 Horizontal alignment in a column

Changed "The horizontal alignment of a cell's content within a cell box is specified with the 'text-align' property" to "The horizontal alignment of a cell's inline content within a cell box can be specified with the 'text-align' property."

C.4.86 Section 17.5.5 Dynamic row and column effects

Clarified that not affecting layout means that 'visibility: collapse' causes the part of row- and column-spanning cells that span into the collapsed row to be clipped.

C.4.87 Section 17.6.1 The separated borders model

Added a note explaining that 'border-spacing' can be used as a substitute for the non-standard 'framespacing' attribute on frameset elements (which are out-of-scope for CSS2.1).

Added clarification about backgrounds: the sentence "This space is filled with the background of the table element" was replaced by:

In this space, the row, column, row group, and column group backgrounds are invisible, allowing the table background to show through.

C.4.88 Section 17.6.2 The collapsing borders model

In the sentence after the question, added "and padding-left_i and padding-right_i refer to the left (resp., right) padding of cell i."

C.4.89 Section 18.2 System Colors

Noted that system colors are deprecated in CSS3.

C.4.90 Section 18.4 Dynamic outlines

Clarified that outlines do not cause overflow.

Clarified that outlines are only fully connected "if possible".

C.4.91 Section 18.4.1 Outlines and the focus

Clarify that changing outlines in response to focus should not cause a document to reflow.

C.4.92 Appendix D Default style sheet for HTML 4

Added paragraph clarifying that some presentational markup in HTML can be replaced with CSS, but it requires different markup.

C.5 Errata since the Candidate Recommendation of July 2007

Errata to CSS 2.1 since CR version of July 19, 2007. [p. ??]

C.5.1 Section 1.4.2.1 Value

[2009-04-15] The notation “&&” may be used in syntax definitions in future CSS specifications.

C.5.2 Section 2.3 The CSS 2.1 processing model

[2008-08-19] The first part of the section is not normative.

C.5.3 Section 3.1 Definitions

[2007-11-14] Append “For raster images without reliable resolution information, a size of 1 px unit per image source pixel must be assumed.” to the definition of “intrinsic dimensions.”

C.5.4 Section 4.1.1 Tokenization

[2007-09-27] Remove “DELIM?” from the grammar rule

```
declaration : DELIM? property S* ':' S* value;
```

The DELIM was allowed there so that unofficial properties could start with a dash (-), but the dash was already allowed because of the definition of “IDENT.”

[2009-02-02] Change \cup to u in token UNICODE-RANGE. (It means the same, but seems to avoid confusion.)

[2009-02-02] Clarify where comments are allowed:

COMMENT tokens do not occur in the grammar (to keep it readable), but any number of these tokens may appear anywhere ~~between~~ outside other tokens. (Note, however, that a comment before or within the @charset rule disables the @charset.)

C.5.5 Section 4.1.2.2 Informative Historical Notes

[2008-12-09] Other known vendor prefixes are: -xv-, -ah-, prince-, -webkit-, and -khtml-.

C.5.6 Section 4.1.3 Characters and case

[2007-11-14] In the second bullet, change “[a-z0-9]” to “[a-zA-Z0-9]”; in the third bullet, change “[0-9a-f]” to “[0-9a-fA-F]”.

Although the preceding bullet already says that CSS is case-insensitive, the explicit mention of upper and lower case letters helps avoid mistakes.

C.5.7 Section 4.1.3 Characters and case

[2008-03-05] CSS is now case-sensitive, except for certain parts:

All CSS syntax is case-insensitive within the ASCII range (i.e., [a-z] and [A-Z] are equivalent), except for parts that are not under the control of CSS.

C.5.8 Section 4.1.3 Characters and case

[2008-12-02] The pair “*/” ends a comment, even if preceded by a backslash. Change this sentence in the third bullet:

Except within CSS comments, any character (except a hexadecimal digit) can be escaped with a backslash to remove its special meaning.

C.5.9 Section 4.1.3 Characters and case

[2009-04-15] Text added to match the grammar:

[] any character (except a hexadecimal digit , linefeed, carriage return or form feed) can be escaped []

C.5.10 Section 4.1.5 At-rules

[2009-04-15] Clarified that unknown statements are ignored when looking for @import:

CSS 2.1 user agents must ignore any ‘@import’ rule that occurs inside a block or after any valid non-ignored statement other than an @charset or an @import rule.

C.5.11 Section 4.1.7 Rule sets, declaration blocks, and selectors

[2008-11-26] More precise statement of what is ignored:

When a user agent cannot parse the selector (i.e., it is not valid CSS 2.1), it must ignore the selector and the following declaration block (if any) as well.

C.5.12 Section 4.2 Rules for handling parsing errors

[2009-04-15] Added error recovery rule for unexpected tokens at the top level:

Malformed statements. User agents must handle unexpected tokens encountered while parsing a statement by reading until the end of the statement, while observing the rules for matching pairs of (), [], {}, "", and ", and correctly handling escapes. For example, a malformed statement may contain an unexpected closing brace or at-keyword. E.g., the following lines are all ignored:

```
p @here {color: red}      /* ruleset with unexpected at-keyword "@here" */
@foo @bar;              /* at-rule with unexpected at-keyword "@bar" */
}} {{ - }}             /* ruleset with unexpected right brace */
) [ {} ] p {color: red } /* ruleset with unexpected right parenthesis */
```

C.5.13 Section 4.2 Rules for handling parsing errors

[2008-11-26] Change “or block” as follows:

User agents must ignore an invalid at-keyword together with everything following it, up to and including the next semicolon (;), ~~or block ({...})~~ the next block ({...}), or the end of the block (}) that contains the invalid at-keyword, whichever comes first.

C.5.14 Section 4.3.2 Lengths

[2008-08-19] Add recommendation about size of px:

[] the user agent should rescale pixel values. It is recommended that the pixel unit refer to the whole number of device pixels that best approximates the reference pixel.

C.5.15 Section 4.3.5 Counters

[2008-03-05] Insert “case-sensitive” in “Counters are denoted by case-sensitive identifiers”.

C.5.16 Section 5.8.1 Matching attributes and attribute values

[2008-04-07] Clarified `~=` and `|=` by using the definitions from the Selectors [p. ??] module.

[2008-11-03] Clarified that `[foo~=]"` (i.e., with an empty value) will not match anything.

C.5.17 Section 5.8.2 Default attribute values in DTDs

[2007-11-14] Replace “`tag selector`” by “`type selector`”.

C.5.18 Section 5.11.4 The language pseudo-class: `:lang`

[2009-04-15] The language code is case-insensitive.

C.5.19 Section 5.12.3 The `:before` and `:after` pseudo-elements

[2008-11-03] Clarified text:

When the `:first-letter` and `:first-line` pseudo-elements are ~~combined with~~ applied to an element having content generated using `:before` and `:after`, they apply to the first letter or line of the element including the ~~inserted text~~ generated content.

C.5.20 Section 6.3 The `@import` rule

[2008-08-19] Add “In CSS 2.1” and “See the section on parsing for when user agents must ignore `@import` rules” to

In CSS 2.1, any `@import` rules must precede all other rules (except the `@charset` rule, if present). See the section on parsing for when user agents must ignore `@import` rules.

C.5.21 Section 6.3 The `@import` rule

[2008-11-26] Define what it means to import a style sheet twice and how the media list is matched. Add at the end:

In the absence of any media types, the import is unconditional. Specifying `'all'` for the medium has the same effect. The import only takes effect if the target medium matches the media list.

A target medium matches a media list if one of the items in the media list is the target medium or `'all'`.

Note that Media Queries [MEDIAQ] extends the syntax of media lists and the definition of matching.

When the same style sheet is imported or linked to a document in multiple places, user agents must process (or act as though they do) each link as though the link were to a separate style sheet.

C.5.22 Section 6.4.1 Cascading order

[2007-11-22] Spelling error: “preceadence”.

C.5.23 Section 6.4.1 Cascading order

[2008-11-26] Define the meaning of a media list:

Find all declarations that apply to the element and property in question, for the target media type. Declarations apply if the associated selector matches the element in question and the target medium matches the media list on all @media rules containing the declaration and on all links on the path through which the style sheet was reached.

C.5.24 Section 7.2.1 The @media rule

[2008-12-02] The rules for parsing unknown statements inside @media blocks were ambiguous. Change the first sentence as follows:

An @media rule specifies the target media types (separated by commas) of a set of rules statements (delimited by curly braces). Invalid statements must be ignored per 4.1.7 "Rule sets, declaration blocks, and selectors" and 4.2 "Rules for handling parsing errors."

Also make it explicit that CSS level 2 (unlike higher levels) has no nested @-rules. Add at the end of the section: "At-rules inside @media are invalid in CSS 2.1."

C.5.25 Section 8.3.1 Collapsing margins

[2008-08-18] In bullet 6, sub-bullet 2, the position of the top border edge is determined by assuming the element has a non-zero *bottom* (not: top) border.

C.5.26 Section 8.3.1 Collapsing margins

[2009-02-02] Rephrased the rule for adjoining margins so that the 'min-height' and 'max-height' of an element have no influence over whether the element's bottom margin is adjoining to its last child's bottom margin.

C.5.27 Section 8.3.1 Collapsing margins

[2008-12-02] Not only elements with 'overflow' other than 'visible', but *all* block formatting contexts avoid collapsing their margins with their children. Change the third bullet as follows:

- Vertical margins of elements with ~~'overflow' other than 'visible'~~ that establish new block formatting contexts (such as floats and elements with 'overflow' other than 'visible') do not collapse with their in-flow children.

C.5.28 Section 9.2.2 Inline-level elements and inline boxes

[2008-12-02] Added missing 'inline-block' in: "Several values of the 'display' property make an element inline: 'inline', 'inline-table', 'inline-block' and 'run-in' (part of the time; see run-in boxes)."

C.5.29 Section 9.2.4 The 'display' property

[2008-04-07] Clarified that 'display: none' also applies to non-visual media.

C.5.30 Section 9.3.2 Box offsets: 'top', 'right', 'bottom', 'left'

[2008-08-19] Remove true but confusing note (occurs 4x):

~~Note: For absolutely positioned elements whose containing block is based on a block-level element, this property is an offset from the padding edge of that element.~~

C.5.31 Section 9.5 Floats

[2008-08-19] Positioned descendants of a float are in the stacking context of the float's parent. Add "positioned elements and" to

[] except that any positioned elements and elements that actually create new stacking contexts take part in the float's parent's stacking context.

Same change in Section 9.9 Layered presentation [p. ??] :

[] except that any positioned elements and any elements that actually create new stacking contexts take part in the parent stacking context."

C.5.32 Section 9.5 Floats

[2008-12-02] Remove "s" that may be misinterpreted: "the float's parent's stacking context."

C.5.33 Section 9.5.2 Controlling flow next to floats: the 'clear' property

[2009-02-02] Add an example of negative clearance after the first note.

C.5.34 Section 9.6.1 Fixed positioning

[2008-11-03] Added:

Boxes with fixed position that are larger than the page box are clipped. Parts of the fixed position box that are not visible in the initial containing block will not print.

C.5.35 Section 9.9.1 Specifying the stack level: the 'z-index' property

[2008-12-02] The list of stacking levels is ambiguous: relatively positioned elements could fall under items 3/4/5 or under item 6. Meant is item 6, so exclude them from 3/4/5 as follows:

1. the background and borders of the element forming the stacking context.
2. the stacking contexts of descendants with negative stack levels.
3. a stacking level containing in-flow non-inline-level non-positioned descendants.
4. a stacking level for non-positioned floats and their contents.
5. a stacking level for in-flow inline-level non-positioned descendants.
6. a stacking level for positioned descendants with 'z-index: auto', and any descendant stacking contexts with 'z-index: 0'.
7. the stacking contexts of descendants with positive stack levels.

C.5.36 Section 10.1 Definition of "containing block"

[2009-02-02] Rephrase first bullet point to make easier to read:

~~The containing block in which the root element lives is a rectangle with the dimensions of the viewport, anchored at the canvas origin for continuous media, and the page area for paged media. This containing block is called the initial containing block.~~

The containing block in which the root element lives is a rectangle called the initial containing block. For continuous media, it has the dimensions of the viewport and is anchored at the canvas origin; it is the page area for paged media.

C.5.37 Section 10.3 Calculating widths and margins

[2009-04-15] The values of 'left' and 'right' are only determined by section 9.4.3 in the case of relatively positioned elements:

For Points 1-6 and 9-10, the values of 'left' and 'right' ~~used for layout~~ in the case of relatively positioned elements are determined by the rules in section 9.4.3. [p. 142]

C.5.38 Section 10.3.1 Inline, non-replaced elements

[2009-04-15] The only case in which 'left' or 'right' can be 'auto' is when the element is statically positioned. In that case 'left' and 'right' are ignored and there is thus no need to determine a used value:

A computed value of 'auto' for 'left', 'right', 'margin-left' or 'margin-right' becomes a used value of '0'.

C.5.39 Section 10.3.2 Inline, replaced elements

[2007-11-14] Add the following paragraph:

Otherwise, if 'width' has a computed value of 'auto', and the element has an intrinsic width, then that intrinsic width is the used value of 'width'.

just before the paragraph beginning "Otherwise, if 'width' has a computed value of 'auto', but none of the conditions above are met, []".

C.5.40 Section 10.3.2 Inline, replaced elements

[2008-03-05] Change the last paragraph as follows:

If it does, ~~then a percentage intrinsic width on that element cannot be resolved and the element is assumed to have no intrinsic width~~ then the resulting layout is undefined in CSS2.1.

C.5.41 Section 10.3.3 Block-level, non-replaced elements in normal flow

[2008-03-05] Scrollbar widths are no longer included in the containing block width. Remove scrollbar width from:

'margin-left' + 'border-left-width' + 'padding-left' + 'width' + 'padding-right' + 'border-right-width' + 'margin-right' + ~~scrollbar width (if any)~~ = width of containing block

and from:

If 'width' is not 'auto' and 'border-left-width' + 'padding-left' + 'width' + 'padding-right' + 'border-right-width' + ~~scrollbar width (if any)~~ [...]

and remove the paragraph:

~~The "scrollbar width" value is only relevant if the user agent uses a scrollbar as its scrolling mechanism. See the definition of the 'overflow' property.~~

C.5.42 Section 10.3.7 Absolutely positioned, non-replaced elements

[2008-03-05] Scrollbar widths are no longer included in the containing block width.

Remove scrollbar width from:

'left' + 'margin-left' + 'border-left-width' + 'padding-left' + 'width' + 'padding-right' + 'border-right-width' + 'margin-right' + 'right' + ~~scrollbar width (if any)~~ = width of containing block

and remove the paragraph:

~~The "scrollbar width" value is only relevant if the user agent uses a scrollbar as its scrolling mechanism. See the definition of the 'overflow' property.~~

C.5.43 Section 10.3.7 Absolutely positioned, non-replaced elements

[2008-03-05] Add the following definition.

[2008-08-19] Add the following note to that definition.

The *static-position containing block* is the containing block of a hypothetical box that would have been the first box of the element if its specified 'position' property had been 'static' and its 'float' had been 'none'. (Note that due to the rules in section 9.7 this hypothetical calculation might require also assuming a different computed value for 'display'.)

And change which 'direction' property is used as follows (two occurrences):

[...] if the 'direction' property of the element establishing the static-position containing block is [...]

C.5.44 Section 10.3.8 Absolutely positioned, replaced elements

[2008-03-05] Change bullet 2 as follows:

[...] if the 'direction' property of the element establishing the static-position containing block is [...]

C.5.45 Section 10.3.8 Absolutely positioned, replaced elements

[2008-03-05] Clarification. Replace

This situation is similar to the previous one, except that the element has an intrinsic width. The sequence of substitutions is now:

by

In this case, section 10.3.7 applies up through and including the constraint equation, but the rest of section 10.3.7 is replaced by the following rules:

C.5.46 Section 10.3.8 Absolutely positioned, replaced elements

[2008-04-07] Clarified that margins are *not* calculated as for inline elements.

C.5.47 Section 10.5 Content height: the 'height' property

Under “<percentage>,” add the same note as under “<percentage>,” in section 10.2 (“Content width: the 'width' property”).

C.5.48 Section 10.6.2 Inline replaced elements [□]

[2007-11-14] Add the following paragraph:

Otherwise, if 'height' has a computed value of 'auto', and the element has an intrinsic height, then that intrinsic height is the used value of 'height'.

just before the paragraph beginning “Otherwise, if 'height' has a computed value of 'auto', but none of the conditions above are met [□]”.

C.5.49 Section 10.6.4 Absolutely positioned, non-replaced elements

[2008-11-26] The static position is determined considering *neither* float *nor* clear. Add this:

[□] and its specified 'float' had been 'none' and 'clear' had been 'none'.

C.5.50 Section 10.6.5 Absolutely positioned, replaced elements

[2008-04-07] Clarified that margins are *not* calculated as for inline elements.

C.5.51 Section 10.8.1 Leading and half-leading

[2007-11-14] In the Note under 'vertical-align', remove “slightly” from “Values of this property have slightly different meanings in the context of tables.”

C.5.52 Section 11.1.1 Overflow: the 'overflow' property

[2008-03-05] Scrollbar widths are no longer included in the containing block width. Replace

~~The space taken up by the scrollbars affects the computation of the dimensions in the rendering model.~~

by

Any space taken up by the scrollbars should be taken out of (subtracted from the dimensions of) the containing block formed by the element with the scrollbars.

[2008-11-03] 'Overflow' on BODY is special not only in HTML but also in XHTML. Change the sentence ~~"HTML UAs must instead apply the 'overflow' property from the BODY element to the viewport, if the value on the HTML element is 'visible'."~~ to:

When the root element is an HTML "HTML" element or an XHTML "html" element, and that element has an HTML "BODY" element or an XHTML "body" element as a child, user agents must instead apply the 'overflow' property from the first such child element to the viewport, if the value on the root element is 'visible'.

C.5.53 Section 11.1.2 Clipping: the 'clip' property

[2008-03-05] Insert "(but not a combination)" in "User agents must support separation with commas, but may also support separation without commas (but not a combination)".

C.5.54 Section 12.2 The 'content' property

[2009-04-15] (And also in section 12.4:) certain keywords, in particular 'none', 'inherit' and 'initial' (the latter being reserved for future use) cannot be used as names for counters.

C.5.55 Section 12.4.2 Counter styles

[2008-03-05] Error in example. Replace hebrew by lower-greek:

```
BLOCKQUOTE:after { content: " [" counter(bq, hebrew lower-greek) "]" }
```

C.5.56 Section 12.5 Lists

[2008-12-01] Change "in" to "with respect to" in

The list properties describe basic visual formatting of lists: they allow style sheets to specify the marker type (image, glyph, or number), and the marker position with respect to the principal box (outside it or within it before content).

because the marker is, as the rest of the sentence itself makes clear, not necessarily *in* the principal box.

C.5.57 Section 12.5.1 Lists: the 'list-style-type', 'list-style-image', 'list-style-position', and 'list-style' properties

[2008-04-07] The size of list style markers without an intrinsic size is now defined.

C.5.58 Section 12.5.1 Lists: the 'list-style-type', 'list-style-image', 'list-style-position', and 'list-style' properties

[2008-12-01] CSS 2.1 does not specify the position of the list item marker, but *does* require it to be on the left or right of the content. Also, the marker is not affected by 'overflow', but *may* influence the height of the principal box. Add to the definition of 'outside':

□ but does require that for list items whose 'direction' property is 'ltr' the marker box be on the left side of the content and for elements whose 'direction' property is 'rtl' the marker box be on the right side of the content. 'overflow' on the element does not clip the marker box. The marker box is fixed with respect to the principal block box's border and does not scroll with the principal block box's content. The size or contents of the marker box may affect the height of the principal block box and/or the height of its first line box, and in some cases may cause the creation of a new line box. Note: This interaction may be more precisely defined in a future level of CSS.

C.5.59 Section 12.5.1 Lists: the 'list-style-type', 'list-style-image', 'list-style-position', and 'list-style' properties

[2009-04-015] Meaning of 'none' for 'list-style' was only defined by an example.

C.5.60 Section 13.2 Page boxes: the @page rule

[2008-08-19] Add rules for drawing canvas to:

- The page area. The page area includes the boxes laid out on that page. The edges of the first page area establish the rectangle that is the initial containing block of the document. The canvas background is painted within and covers the page area.
- The margin area, which surrounds the page area. The page margin area is transparent.

C.5.61 Section 13.2.1.1 Rendering page boxes that do not fit a target sheet

[2009-02-02]

Remove sections 13.2.1.1 and 13.2.1.2. (The described situations cannot occur in CSS 2.1, because CSS 2.1 does not have a 'size' property.)

C.5.62 Section 13.2.3 Content outside the page box

[2008-11-03] Clarified what locations are inconvenient for printing:

When formatting content in the page model, some content may end up outside the current page box. For example, an element whose 'white-space' property has the value 'pre' may generate a box that is wider than the page box. As another example, when boxes are positioned absolutely or relatively, they may end up in "inconvenient" locations. For example, images may be placed on the edge of the page box or 100,000 meters below the page box.

C.5.63 Section 13.3.1 Page break properties:

'page-break-before', 'page-break-after', 'page-break-inside'

[2008-04-30] The 'page-break-inside' property no longer inherits.

C.5.64 Section 13.3.1 Page break properties:

'page-break-before', 'page-break-after', 'page-break-inside'

[2008-12-01] UAs *may* apply 'page-break-before', 'page-break-after' and 'page-break-inside' to other elements than block-level ones.

C.5.65 Section 13.3.2 Breaks inside elements: 'orphans', 'widows'

[2009-02-02] "Paragraph" is not a defined term. Change ~~of a paragraph~~ to in a block element (twice).

C.5.66 Section 13.3.2 Breaks inside elements: 'orphans', 'widows'

[2009-04-15] 'Widows' and 'orphans' only accept positive values.

C.5.67 Section 13.3.3 Allowed page breaks

[2008-04-30] The 'page-break-inside' property of all ancestors is checked for page-breaking restrictions, not just that of the breakpoint's parent.

C.5.68 Section 13.3.3 Allowed page breaks

[2009-02-02] Remove possible confusion:

Rule D: In addition, breaking at (2) is allowed only if the 'page-break-inside' property of the element and all its ancestors is 'auto'.

C.5.69 Section 13.3.3 Allowed page breaks

[2009-02-02] Top margins do *not* disappear at a page break that is forced by a 'page-break-after' or 'page-break-before'. Correct the first bullet to:

When an unforced page break occurs here, the used values of the relevant 'margin-top' and 'margin-bottom' properties are set to '0'. When a forced page break occurs here, the used value of the relevant 'margin-bottom' property is set to '0'; the relevant 'margin-top' used value may either be set to '0' or retained.

And add the following note:

Note: It is expected that CSS3 will specify that the relevant 'margin-top' applies (i.e., is not set to '0') after a forced page break.

C.5.70 Section 13.3.5 "Best" page breaks

[2009-02-02] Remove the advice to user agents to avoid breaking inside elements with borders, inside tables or inside floating elements; add the advice to avoid breaking inside replaced elements.

C.5.71 Section 14.2 The background

[2008-11-03] The 'background' property is special on BODY not only in HTML but also in XHTML.

C.5.72 Section 14.2 The background

[2009-04-15] The whole 'background' property is used for the canvas, not just the color and the image:

For documents whose root element is an HTML "HTML" element or an XHTML "html" element that has computed values of 'transparent' for 'background-color' and 'none' for 'background-image', user agents must instead use the computed value of these the background properties from that element's first HTML "BODY" element or XHTML "body" element child [□]

C.5.73 Section 14.2.1 Background properties: 'background-color', 'background-image', 'background-repeat', 'background-attachment', 'background-position', and 'background'

[2008-04-07] The size of background images without an intrinsic size is now defined.

C.5.74 Section 15.6 Font boldness: the 'font-weight' property

[2008-11-26] Remove incorrect text:

- 'bolder' selects the next weight that is assigned to a font that is darker than the inherited one. ~~If there is no such weight, it simply results in the next darker numerical value (and the font remains unchanged), unless the inherited value was '900' in which case the resulting weight is also '900'.~~
- 'lighter' is similar, but works in the opposite direction: it selects the next lighter keyword with a different font from the inherited one, ~~unless there is no such font, in which case it selects the next lighter numerical value (and keeps the font unchanged).~~

and:

The computed value of "font-weight" is either:

- one of the legal number values, or
- ~~one of the legal number values combined with one or more of the relative values (bolder or lighter). This type of computed values is necessary to use when the font in question does not have all weight variations that are needed.~~

And instead add this note:

Note: A set of nested elements that mix 'bolder' and 'lighter' will give unpredictable results depending on the UA, OS, and font availability. This behavior will be more precisely defined in CSS3.

C.5.75 Section 16.6 Whitespace: the 'white-space' property

[2008-08-19] Remove rules about generated text from:

The following examples show what whitespace behavior is expected from the PRE and P elements, the "nowrap" attribute in HTML, ~~and in generated content.~~

```
pre      { white-space: pre }
p        { white-space: normal }
td[nowrap] { white-space: nowrap }
:-before, :-after { white-space: pre-line }
```

C.5.76 Section 16.6.1 The 'white-space' processing model

[2009-02-02] Collapsing of white space does not remove any line breaking opportunities. Add the following clarification:

Then, the entire block is rendered. Inlines are laid out, taking bidi reordering into account, and wrapping as specified by the 'white-space' property. When wrapping, line breaking opportunities are determined based on the text prior to the white space collapsing steps above.

C.5.77 Section 17.2.1 Anonymous table objects

[2007-11-14] Spelling error: "boxess".

C.5.78 Section 17.2.1 Anonymous table objects

[2008-10-13] Added new rule after bullet 4:

5. If a child T of a 'table', 'inline-table', 'table-row-group', 'table-header-group', 'table-footer-group', or 'table-row' box is an anonymous inline box that contains only white space, then it is treated as if it has 'display: none'.

C.5.79 Section 17.4 Tables in the visual formatting model

[2009-02-02] The anonymous block containing the table and its caption establishes a block formatting context:

The anonymous box is a 'block' box if the table is block-level, and an 'inline-block' box if the table is inline-level ~~except that this block is never considered as a block for 'run-in' interaction, and that~~ The anonymous box establishes a block formatting context. The table box (not the anonymous box) is used when doing baseline vertical alignment for an 'inline-table'.

The diagram now shows the caption's margins *inside* the anonymous box.

C.5.80 Section 17.5.4 Horizontal alignment in a column

[2008-04-07] Clarification:

The horizontal alignment of a cell's inline content within a cell box is can be specified ~~with the 'text-align' property~~ by the value of the 'text-align' property on the cell.

C.5.81 Section 18.1 Cursors: the 'cursor' property

[2008-04-07] The size of cursors without an intrinsic size is now defined.

C.5.82 Section B.2 Informative references

[2007-11-14] Spelling error: change “?lik” to “Çelik” (2x).

C.5.83 Appendix D. Default style sheet for HTML 4

[2008-08-19] Replace

```
br:before      { content: "\A" }
:before, :after { white-space: pre-line }
```

with

```
br:before      { content: "\A"; white-space: pre-line }
```

C.5.84 Appendix D. Default style sheet for HTML 4

[2008-08-19] Add tr to:

```
td, th, tr     { vertical-align: inherit }
```

C.5.85 Section E.2 Painting order

[2007-11-14] Replace “but any descendants which actually create a new stacking context” by “but any positioned descendants and descendants which actually create a new stacking context”.

C.5.86 Appendix G. Grammar of CSS 2.1

[2007-09-27] Change the last “S” in the grammar rule for “combinator” to “S+”:

```
combinator
  : PLUS S*
  | GREATER S*
  | S+
```

and remove the rule

```
{s}+ \ \ * [^*] * \ * + ( [^/*] [^*] * \ * + ) * \ / {unput(' '); /*replace by space*/}
```

in the tokenizer. The resulting language is the same, but the grammar is easier to read and relies less on specific notations of Flex.

C.5.87 Section G.1 Grammar

[2007-09-27] Changes to remove ambiguity with respect to the S token and avoid nullable non-terminals.

C.5.88 Section G.2 Lexical scanner

[2007-09-27] Change the tokenizer rule

```
@{C}{H}{A}{R}{S}{E}{T} {return CHARSET_SYM;}
```

to

```
@charset " {return CHARSET_SYM;}
```

The @charset must be in lowercase and must have a space after it (as defined in section 4.4 CSS style sheet representation [p. ??]).

C.5.89 Section G.2 Lexical scanner

[2008-03-05] Change the tokenizer rules

```
url("{w}{string}{w}") {return URI;}
```

```
url("{w}{url}{w}") {return URI;}
```

to

```
{U}{R}{L}("{w}{string}{w}") {return URI;}
```

```
{U}{R}{L}("{w}{url}{w}") {return URI;}
```

C.5.90 Section G.2 Lexical scanner

[2008-04-07] The definition of the macro “O” is wrong. The letters O and o can be written with hexadecimal escapes as “\4f” and “\6f” respectively (*not* as “\51” and “\71”). The macro should therefore be

```
o o|\0{0,4}(4f|6f)(\r\n|[\t\r\n\f])?|\0o
```

C.5.91 Section G.2 Lexical scanner

“The two occurrences of “\377””: There is in fact only one occurrence.

C.5.92 Appendix I. Index

Add a TITLE attribute to all links and which is equal to the lemma.

C.6 Errata since the Candidate Recommendation of April 2009

These are the errata for CSS level 2 revision 1, CR version of 23 April 2009. [p. ??]
These corrections have the status of a draft.

C.6.1 Section 4.2 Rules for handling parsing errors

[2009-08-06] Clarified the rules for ignoring invalid at-keywords:

Invalid at-keywords. User agents must ignore an invalid at-keyword together with everything following it, up to the end of the block that contains the invalid at-keyword, or up to and including the next semicolon (;), or up to and including the next block ({...}), ~~or the end of the block (}) that contains the invalid at-keyword,~~ whichever comes first.

C.6.2 Section 13.3.3 Allowed page breaks

[2009-08-06] Page breaks are also allowed when there is a gap after the last content of a block. Added the following to the first list:

3. Between the content edge of a block box and the outer edges of its child content (margin edges of block-level children or line box edges for inline-level children) if there is a (non-zero) gap between them.

C.6.3 Section 15.3 Font family: the 'font-family' property

[2009-08-31] The list of keywords in “(e.g., 'initial', 'inherit', 'default', 'serif', 'sans-serif', 'monospace', 'fantasy', and 'cursive’)” isn't an example, but is in fact the complete and normative list.

C.6.4 Section 15.3.1.1 serif

[2009-08-31] Spelling errors in font names. The correct names are “Excelsior Cyrillic Upright” and “ER Bukinist.”

C.6.5 Section 15.7 Font size: the 'font-size' property

[2009-08-31] The two notes “Note: implementation experience has demonstrated□” and “Note 2. In CSS1, the suggested scaling factor□ say essentially the same thing. They are replaced by a single note:

Note 2. In CSS1, the suggested scaling factor between adjacent indexes was 1.5, which user experience proved to be too large. In CSS2, the suggested scaling factor for a computer screen between adjacent indexes was 1.2, which still created issues for the small sizes. Implementation experience has demonstrated that a fixed ratio between adjacent absolute-size keywords is problem-

atic, and this specification does *not* recommend such a fixed ratio.

C.6.6 Section 17.5.2.1 Fixed table layout

[2009-05-20] UAs *may* render extra columns if there are unexpected columns in later rows of a 'fixed' table layout. In that case, the width of the columns and of the table is undefined.

C.6.7 Section 17.5.3 Table height layout

[2009-08-06] Replaced “Percentage heights on table cells, table rows, and table row groups compute to 'auto'” by

CSS 2.1 does not define how the height of table cells and table rows is calculated when their height is specified using percentage values. CSS 2.1 does not define the meaning of 'height' on row groups.

C.6.8 Appendix G. Grammar of CSS 2.1

[2009-08-06] Removed ambiguities from the grammar. (The ambiguities only affected spaces and were harmless.)

C.7 Errata since the Candidate Recommendation of September 2009

These are the errata for CSS level 2 revision 1, CR version of 8 September 2009. [p. ??] These corrections have the status of a draft.

C.7.1 Section 1.4.2.1 Value

[2010-08-06] (Also in various other sections throughout the specification.) Distinguished all cases where the word *value* referred to a whole property value from where it referred to only part of such a value (such as a component in a comma-separated list). The former is now *property value*, the latter *component value*.

C.7.2 Section 3.1 Definitions

[2010-04-19] Add a clarification to the definition of replaced element:

The content of replaced elements is not considered in the CSS rendering model.

(Previously, the definition only said that the content was “outside the scope of CSS.”)

C.7.3 Section 4.1.1 Tokenization

[2010-04-19] The definition of “identifier” in 4.1.3 (2nd bullet) and in the grammar were contradictory w.r.t. whether no-break space (U+00A0) was allowed in identifiers or not. Change the text in 4.1.3 to allow no-break space: “characters U+00A1 U+00A0 and higher.”

Also, change the macro “nonascii” in the token definition from “[\A0-\177]” to “[\A0-\237]”. (When CSS was first written, Unicode didn’t have code points U+0080 to U+009F, i.e., \200-\237 in octal.)

C.7.4 Section 4.1.1 Tokenization

[2010-09-29] The tokenizer has been modified so that it can be implemented as a state machine without back-up (e.g., with Lex). This changes the meaning of an input of the form “url(□(□)□)”, i.e., input that starts like a URI token but then contains a parenthesis (which is not allowed in a URI token). Previously, such input was re-parsed to yield a FUNCTION token followed by other things; now it yields a BAD_URI token. Given that CSS has never used a FUNCTION token of the form “url(” this should not affect any existing CSS style sheets.

A non-normative section has been added to appendix G with an explanation of how to make a tokenizer without back-up.

C.7.5 Section 4.1.1 Tokenization

[2010-09-29] The definition of the URI token was ambiguous: it allowed a backslash to be either parsed on its own or as part of an escape. A backslash in a URI token must always be interpreted as part of an escape.

C.7.6 Section 4.1.1 Tokenization

[2010-09-29] Error handling for illegal tokens (braces, at-keywords, and SGML comment tokens) inside parenthesized expressions was not well defined. Change the production for “any” as follows

```
any          : [ IDENT | NUMBER | PERCENTAGE | DIMENSION | STRING
                | DELIM | URI | HASH | UNICODE-RANGE | INCLUDES
                | DASHMATCH | ':' | FUNCTION S* [any|unsused]* ')'
                | '(' S* [any|unused]* ')' | '[' S* [any|unused]* ']'
                ] S*;
unused      : block | ATKEYWORD S* | ';' S* | CDO S* | CDC S*;
```

and add the following explanation:

The “unused” production is not used in CSS and will not be used by any future extension. It is included here only to help with error handling. (See 4.2 “Rules for handling parsing errors.”)

C.7.7 Section 4.1.2.2 Informative Historical Notes

[2010-04-19] Add “-tc-” to the list of existing vendor prefixes.

C.7.8 Section 4.1.3 Characters and case

[2010-08-06] The handling of a backslash before a newline or at the end of a file is no longer undefined: it is parsed as a DELIM.

C.7.9 Section 4.1.3 Characters and case

[2010-08-06] Make text and formal grammar the same:

In CSS, identifiers []; they cannot start with a digit, two hyphens, or a hyphen followed by a digit.

C.7.10 Section 4.1.8 Declarations and properties

[2010-05-12] Remove “2.1” from

Every CSS 2.1 property has its own syntactic and semantic restrictions

C.7.11 Section 4.2 Rules for handling parsing errors

[2010-07-07] Clarify that the fifth bullet only applies to at-rules. (At-keywords in other constructs are already handled in the preceding bullets.)

- **Invalid at-keywords At-rules with unknown at-keywords.** User agents must ignore

C.7.12 Section 4.3.2 Lengths

[2010-04-19] Make explicit that ‘ex’, when used in the ‘font-size’ property, refers to the *parent element’s* ‘ex’ (just as ‘em’ refers to the parent’s ‘em’ in that case.)

C.7.13 Section 4.3.2 Lengths

[2010-10-28] A UA must now *either* display absolute lengths (cm, in, pt, etc.) at their real size *or* make px align with device pixel boundaries near the 0.0213 degrees viewing angle, but not both. In either case, 3px must equal 4pt.

(Until now, authors could use absolute lengths for physical sizes and px for aligning to device pixels, but couldn’t know the number of pt in a px, except in combination with Media Queries. Authors can no longer choose between absolute or device-related units, but can use px and pt interchangeably. This should only affect relatively low-resolution devices: above 300 dots per inch, the maximum error is about 16%.)

C.7.14 Section 4.3.4 URLs and URIs

[2010-05-12] Commas do not have to be escaped in <uri> tokens:

Some characters appearing in an unquoted URI, such as parentheses, commas, white space characters, single quotes (') and double quotes ("), must be escaped

C.7.15 Section 4.3.4 URLs and URIs

[2010-04-21] Describe in English what was only expressed through the grammar:

Note. Since URIs may contain characters that would otherwise be used as delimiters in CSS, the entire URI value must be treated as a single unit by the tokenizer and normal tokenization behavior does not apply within a URI value. Therefore comments are not allowed within a URI value.

C.7.16 Section 5.8.2 Default attribute values in DTDs

[2010-09-29] Clarify what is meant by "is not required":

More precisely, a UA may, but is *not* required to, read an "external subset" of the DTD but *is* required to look for default attribute values in the document's "internal subset." (See [XML10] for definitions of these subsets.) Depending on the UA, a default attribute value defined in the external subset of the DTD might or might not appear in the document tree.

A UA that recognizes an XML namespace [XMLNAMESPACES] may, but is not required to, use its knowledge of that namespace to treat default attribute values as if they were present in the document. (E.g., an XHTML UA is not required to use its built-in knowledge of the XHTML DTD.)

and:

the first rule ~~will~~ might not match elements whose "notation" attribute is set by default, i.e., not set explicitly. To catch all cases, the attribute selector for the default value must be dropped:

C.7.17 Section 5.11.4 The language pseudo-class: :lang

[2010-08-06] The argument of ':lang()' is only case-insensitive for characters in ASCII.

C.7.18 Section 5.12 Pseudo-elements

[2010-08-06] Clarify that pseudo-elements behave like elements for the aspects not explicitly mentioned:

Pseudo-elements behave just like real elements in CSS with the exceptions described below and elsewhere. [p. ??]

C.7.19 Section 5.12.1 The :first-line pseudo-element

[2010-08-24] More consistent use of “block” and “block-level.” Change:

The :first-line pseudo-element can only be attached to a ~~block-level element, inline-block, table-caption or a table-cell~~ block container element.

C.7.20 Section 5.12.2 The :first-letter pseudo-element

[2010-08-24] More consistent use of “block” and “block-level.” Change:

The :first-letter pseudo-element applies to ~~block, list-item, table-cell, table-caption and inline-block elements~~ block container elements.

C.7.21 Section 6.2 Inheritance

[2010-08-06] Add a note that, because it follows the document tree, inheritance is not intercepted by anonymous boxes

C.7.22 Section 6.4.4 Precedence of non-CSS presentational hints

[2010-10-05] Give other languages than HTML (such as SVG) the possibility to define certain attributes as “presentational attributes”:

For other languages, all document language-based styling ~~should be handled in the user agent style sheet~~ must be translated to the corresponding CSS and either enter the cascade at the user agent level or, as with HTML presentational hints, be treated as author level rules with a specificity of zero placed at the start of the author style sheet.

C.7.23 Section 7.3 Recognized media types

[2010-09-08] Clarify what is ignored. Change:

@media and @import rules with unknown media types (that are nonetheless valid identifiers) are treated as if the unknown media types are not present. If an @media/@import rule contains a malformed media type (not an identifier) then the statement is invalid.

C.7.24 Section 8.3.1 Collapsing margins

[2010-05-12] Simplify/clarify text:

An element that has ~~had clearance applied to it~~ never collapses

and:

When an element's own margins collapse, and that element has ~~had clearance applied to it~~

C.7.25 Section 8.3.1 Collapsing margins

[2010-08-24] More consistent use of “block box” vs “block-level element.” Include table captions in the set of block-level elements. See also changes to 9.2.1 [p. 411] and to 9.2.1.1. [p. 412]

Two or more adjoining vertical margins of block-level boxes in the normal flow collapse.

and

The top margin of an in-flow ~~block-level element~~ block box is adjoining to its first in-flow block-level child's top margin

and

The bottom margin of an in-flow ~~block-level element~~ block box with a 'height' of 'auto'

C.7.26 Section 9.2.1 Block-level elements and block boxes

[2010-08-24] Define the term “block-level element” more precisely. Also define auxiliary terms “block container box” and “block box”:

More consistent use of block box vs block-level element in section 9.2.1.1. See also changes to section 8.3.1 [p. 411] and 9.4. [p. 414]

C.7.27 Section 9.2.1.1 Anonymous block boxes

[2010-05-12] The example has invalid HTML mark-up. Change it to use P and SPAN elements instead of BODY and P.

[2010-08-06] Also clarify that “block box” only refers to boxes in the same flow.

C.7.28 Section 9.2.1.1 Anonymous block boxes

[2010-09-29] Percentage values that refer to dimensions of parent boxes ignore any intervening anonymous boxes. Add this paragraph:

Anonymous block boxes are ignored when resolving percentage values that would refer to it: the closest non-anonymous ancestor box is used instead. For example, if the child of the anonymous block box inside the DIV above needs to know the height of its containing block to resolve a percentage height, then it will use the height of the containing block formed by the DIV, not of the anonymous block box.

C.7.29 Section 9.2.1.1 Anonymous block boxes

[2010-09-29] Clarify the wording:

When an inline box contains an in-flow block box [□] When such an inline box is affected by relative positioning, the relative positioning also affects the block-level box contained in the block box.

C.7.30 Section 9.2.1.1 Anonymous block boxes

[2010-10-13] Clarify that an inline box that is broken around a block-level box is always broken into two pieces, even if one or both are empty:

When an inline box contains an in-flow block-level box, the inline box (and its inline ancestors within the same line box) are broken around the block-level box, dividing the inline box into two pieces, even if either side is empty..

C.7.31 Section 9.2.2 Inline-level elements and inline boxes

[2010-08-24] Better define the term “inline-level element/box” and define the auxiliary terms “inline box” and “atomic inline-level box.”

C.7.32 Section 9.2.3 Run-in boxes

[2010-04-19] Make the definition of ‘run-in’ more precise:

A run-in box behaves as follows:

- 1. If the run-in box contains a block box, the run-in box becomes a block box.*
- 2. If a sibling block box (that does not float and is not absolutely positioned) follows the run-in box, the run-in box becomes the first inline box of the block box. A run-in cannot run in to a block that already starts with a run-in or that itself is a run-in.*
- 3. Otherwise, the run-in box becomes a block box.*

A run-in element (or pseudo-element) A behaves as follows:

1. If A has any children that inhibit run-in behavior (see below), then A is rendered as if it had 'display: block'.
2. Let B be the first of A's following siblings that is neither floating nor absolutely positioned nor has 'display: none'. If B exists and has a specified value for 'display' of 'block' or 'list-item' and is not replaced, then A is rendered as an 'inline' element at the start of B's principal box. Note: A is rendered before B's ':before' pseudo-element, if any. See 12.1.
3. Otherwise, A is rendered as if it had 'display: block'.

In the above, "siblings" and "children" include both normal elements and :before/:after pseudo-elements.

An element or pseudo-element C inhibits run-in behavior if one of the following is true. (Note that the definition is recursive.)

1. C is not floating and not absolutely positioned and the computed value of its 'display' is one of 'block', 'list-item', 'table' or 'run-in'.
2. C has a computed value for 'display' of 'inline' and it has one or more children that inhibit run-in behavior. (Where "children" includes both normal elements and :before/:after pseudo-elements.)

It remains undefined how 'run-in' and ':first-line' interact:

It is undefined in CSS 2.1 if a run-in inherits from a ':first-line' pseudo-element.

C.7.33 Section 9.2.4 The 'display' property

[2010-08-06] Use the same terminology as in chapter 12:

list-item

This value causes an element (e.g., LI in HTML) to generate a principal block box and a ~~list-item inline~~ marker box.

C.7.34 Section 9.2.4 The 'display' property

[2010-08-24] More consistent use of "inline-level."

inline-block

This value causes an element to generate a ~~block box, which itself is flowed as a single inline box, similar to a replaced element~~ inline-level block container. The inside of an inline-block is formatted as a block box, and the element itself is formatted as an ~~inline-replaced element~~ atomic inline-level box.

C.7.35 Section 9.3 Positioning schemes

[2010-08-24] More consistent use of “inline-level” and “block-level.”

1. Normal flow. In CSS 2.1, normal flow includes block formatting of block-level boxes, inline formatting of inline-level boxes, relative positioning of block-level or and inline-level boxes, and positioning formatting of run-in boxes.

C.7.36 Section 9.4 Normal flow

[2010-08-24] More consistent use of “inline-level” and “block-level.”

Boxes in the normal flow belong to a formatting context, which may be block or inline, but not both simultaneously. Block-level boxes participate in a block formatting context. Inline-level boxes participate in an inline formatting context.

In 9.4.1:

~~Floats, absolutely positioned elements, inline-blocks, table-cells, table-captions, and elements with 'overflow' other than 'visible' (except when that value has been propagated to the viewport) establish new block formatting contexts~~ block containers (such as inline-blocks, table-cells, and table-captions) that are not block boxes, and block boxes with 'overflow' other than 'visible'.

In a block formatting context, boxes are laid out one after the other, vertically, beginning at the top of a containing block. The vertical distance between two sibling boxes is determined by the 'margin' properties. Vertical margins between adjacent block-level boxes in a block formatting context collapse.

In 9.4.2:

[\square] When several inline-level boxes cannot fit horizontally within a single line box, they are distributed among two or more vertically-stacked line boxes.

When the total width of the inline-level boxes on a line [\square] is less than the width of the line box containing them, their horizontal distribution within the line box is determined by the 'text-align' property. If that property has the value 'justify', the user agent may stretch spaces and words in inline boxes (except for but not inline-table and inline-block boxes) as well.

C.7.37 Section 9.3.2 Box offsets: 'top', 'right', 'bottom', 'left'

[2010-07-19] If 'top', 'right', 'bottom' or 'left' is specified as 'auto', the used value rather than the computed value is set to the negative of the opposite side. For all four, change:

Computed value: *for 'position:relative', see section Relative Positioning. For 'position:static', 'auto'. Otherwise: if specified as a length, the corresponding absolute length; if specified as a percentage, the specified value; otherwise, 'auto'.*

And in section 9.4.3:

[] Since boxes are not split or stretched as a result of 'left' or 'right', the computed used values are always: left = -right.

If both 'left' and 'right' are 'auto' (their initial values), the computed used values are '0' (i.e., the boxes stay in their original position).

If 'left' is 'auto', its computed used value is minus the value of 'right' (i.e., the boxes move to the left by the value of 'right').

If 'right' is specified as 'auto', its computed used value is minus the value of 'left'.

[] Since boxes are not split or stretched as a result of 'top' or 'bottom', the computed used values are always: top = -bottom. If both are 'auto', their computed used values are both '0'. If one of them is 'auto', it becomes the negative of the other. If neither is 'auto', 'bottom' is ignored (i.e., the computed used value of 'bottom' will be minus the value of 'top').

C.7.38 Section 9.5 Floats

[2010-08-24] More consistent use of “inline-level” and “block-level.”

[] In other words, if inline-level boxes are placed on the line before a left float is encountered that fits in the remaining line box space, the left float is placed on that line, aligned with the top of the line box, and then the inline-level boxes already on the line are moved accordingly to the right of the float (the right being the other side of the left float) and vice versa for rtl and right floats.

In 9.5.2:

Values have the following meanings when applied to non-floating block-level boxes:

C.7.39 Section 9.5 Floats

[2010-10-25] Define exactly what it means for a line box to be next to a float:

[] However, line boxes created next to the float are shortened to make room for the margin box of the float.

A line box is next to a float when there exists a vertical position that satisfies all of these four conditions: (a) at or below the top of the line box, (b) at or above the bottom of the line box, (c) below the top margin edge of the float, and (d)

above the bottom margin edge of the float.

Note: this means that floats with zero height or negative height do not move line boxes.

C.7.40 Section 9.5.2 Controlling flow next to floats: the 'clear' property

[2010-05-12] Clarify that 'clear' only introduces clearance above an element if necessary; and that clearance may have zero height.

C.7.41 Section 9.5.2 Controlling flow next to floats: the 'clear' property

[2010-10-13] Added an example of calculating clearance from two collapsing margins M1 and M2 and the height H of a float.

C.7.42 Section 9.5.2 Controlling flow next to floats: the 'clear' property

[2010-10-13] Clarify the language:

Computing the clearance of an element on which 'clear' is set is done by first determining the hypothetical position of the element's top border edge within its parent block. ~~This position is determined after the top margin of the element has been collapsed with previous adjacent margins (including the top margin of the parent block).~~ This position where the actual top border edge would have been if the element had a non-zero top border and its 'clear' property had been 'none'.

If this hypothetical position of the element's top border edge is not past the relevant floats, then clearance ~~must be~~ is introduced, and margins collapse according to the rules in 8.3.1.

Then the amount of clearance is set to the greater of:

1. The amount necessary to place the border edge of the block even with the bottom outer edge of the lowest float that is to be cleared.
2. ~~The amount necessary to make the sum of the following equal to the distance to which these margins collapsed when the hypothetical position was calculated:~~
 - ~~the margins collapsing above the clearance~~
 - ~~the clearance itself~~
 - ~~if the block's own margins collapse together: the block's top margin~~
 - ~~if the block's own margins do not collapse together: the margins collapsing below the clearance~~

The amount necessary to place the top border edge of the block at its hypothetical position.

C.7.43 Section 9.5.2 Controlling flow next to floats: the 'clear' property

[2010-10-13] Correction: The hypothetical position is determined by assuming the box has a non-zero bottom border (see section 8.3.1):

This position is where the actual top border edge would have been if the element had a non-zero top bottom border and its 'clear' property had been 'none'.

C.7.44 Section 9.6.1 Fixed positioning

[2010-04-19] 'Fixed' backgrounds in paged media are positioned relative to the page box (and thus repeat on every page, just like 'fixed' elements). The position of fixed backgrounds in paged media was previously undefined.

C.7.45 Section 9.9.1 Specifying the stack level: the 'z-index' property

[2010-07-07] Some ambiguities in the description of stacking contexts are fixed and the description is clearly marked as non-normative. (Appendix E holds the normative description.)

C.7.46 Section 9.10 Text direction: the 'direction' and 'unicode-bidi' properties

[2010-08-24] More consistent use of "inline-level" and "block-level."

User agents that support bidirectional text must apply the Unicode bidirectional algorithm to every sequence of inline-level boxes uninterrupted by a forced line break or block boundary. This sequence forms the "paragraph" unit in the bidirectional algorithm. The paragraph embedding level is set according to the value of the 'direction' property of the containing block rather than by the heuristic given in steps P2 and P3 of the Unicode algorithm.

[]

For the 'direction' property to affect reordering in inline-level elements, the 'unicode-bidi' property's value must be 'embed' or 'override'.

[]

normal

The element does not open an additional level of embedding with respect to the bidirectional algorithm. For inline-level elements, implicit reordering works across element boundaries.

embed

If the element is inline-level, this value opens an additional level of embedding with respect to the bidirectional algorithm. The direction of this embed-

ding level is given by the 'direction' property. Inside the element, reordering is done implicitly. This corresponds to adding a LRE (U+202A; for 'direction: ltr') or RLE (U+202B; for 'direction: rtl') at the start of the element and a PDF (U+202C) at the end of the element.

bidirectional-override

For inline-level elements this creates an override. For ~~block-level, table-cell, table-caption, or inline-block~~ block container elements this creates an override for inline-level descendants not within another block-level, table-cell, table-caption, or inline-block element. This means that inside the element, reordering is strictly in sequence according to the 'direction' property; the implicit part of the bidirectional algorithm is ignored. This corresponds to adding a LRO (U+202D; for 'direction: ltr') or RLO (U+202E; for 'direction: rtl') at the start of the element or at the start of each anonymous child block box, if any, and a PDF (U+202C) at the end of the element.

The final order of characters in each ~~block-level-element~~ block container is []

C.7.47 Section 9.10 Text direction: the 'direction' and 'unicode-bidi' properties

[2010-10-05] Add a reference to bidi class B [p. ??] in Unicode TR 9 to clarify what a "forced break" is in the context of the Unicode bidi algorithm:

[] inline-level boxes uninterrupted by a forced ~~line~~ (bidi class B [p. ??]) break or block boundary

C.7.48 Section 9.10 Text direction: the 'direction' and 'unicode-bidi' properties

[2010-10-25] clarify "non-textual entities":

In this process, ~~non-textual entities such as images~~ replaced elements with 'display: inline' (and replaced elements with 'display: run-in', when they generate inline-level boxes) are treated as neutral characters, []

C.7.49 Section 10.1 Definition of "containing block"

[2010-08-24] More consistent use of "inline-level" and "block-level."

1. []
2. For other elements, if the element's position is 'relative' or 'static', the containing block is formed by the content edge of the nearest ~~block-level, table-cell or inline-block~~ block container ancestor box.
3. []
4. []
 1. In the case that the ancestor is ~~inline-level~~ an inline box, the containing block depends on the 'direction' property of the ancestor:

C.7.50 Section 10.2 Content width: the 'width' property

[2010-05-12] The computed value of 'width' doesn't depend on whether the property applies or not:

Computed value: the percentage or 'auto' as specified or the absolute length; 'auto' if the property does not apply

C.7.51 Section 10.2 Content width: the 'width' property

[2010-08-24] More consistent use of "inline-level" and "block-level."

This property specifies the content width of boxes ~~generated by block-level and replaced elements.~~

This property does not apply to non-replaced inline-level elements.

C.7.52 Section 10.2 Content width: the 'width' property

[2010-10-05] Remove unclear and redundant sentence:

~~The width of a replaced element's box is intrinsic and may be scaled by the user agent if the value of this property is different than 'auto'.~~

C.7.53 Section 10.5 Content height: the 'height' property

[2010-05-12] The computed value of 'height' doesn't depend on whether the property applies or not:

Computed value: the percentage or 'auto' (see prose under <percentage>) or the absolute length; 'auto' ~~if the property does not apply~~

C.7.54 Section 10.5 Content height: the 'height' property

[2010-08-24] More consistent use of "inline-level" and "block-level."

This property specifies the content height of boxes ~~generated by block-level, inline-block and replaced elements.~~

This property does not apply to non-replaced inline-level elements. See the section on computing heights and margins for non-replaced inline elements for the rules used instead.

C.7.55 Section 10.6.7 'Auto' heights for block formatting context roots

[2010-08-06] Clarify "bottom" and "preceding":

In certain cases (see ~~the preceding sections~~ e.g., sections 10.6.4 and 10.6.6), the height of an element that establishes a block formatting context is computed as follows:

[]

In addition, if the element has any floating descendants whose bottom margin edge is below the ~~bottom~~ the element's bottom content edge, then the height is increased to include those edges. Only floats that are children of the element itself or of descendants in the normal flow are taken into account, e.g., floats inside absolutely positioned descendants or other floats are not.

C.7.56 Section 10.7 Minimum and maximum heights: 'min-height' and 'max-height'

[2010-10-26] The effect of 'min-height' and 'max-height' on table cells is still undefined in CSS:

In CSS 2.1, the effect of 'min-height' and 'max-height' on table cells, table rows, and row groups is undefined.

C.7.57 Section 10.8 Line height calculations: the 'line-height' and 'vertical-align' properties

[2010-06-02] Clarifications to the calculation of the line boxes and the minimum line height ("strut"). Item 2 in the bulleted list is expanded and items 3 and 4 are merged, as follows:

1. The height of each inline box in the line box is calculated (see "Calculating heights and margins" and the 'line-height' property).
2. The inline boxes are aligned vertically according to their 'vertical-align' property. In case they are aligned 'top' or 'bottom', they must be aligned so as to minimize the line box height. If such boxes are tall enough, there are multiple solutions and CSS 2.1 does not define the position of the line box's baseline (i.e., the position of the strut, see below).
3. The line box height is the distance between the uppermost box top and the lowermost box bottom. (This includes the strut, as explained under 'line-height' below.)
4. ~~If the resulting height is smaller than the minimal height of line boxes for this block, as specified by the 'line-height' property, the height is increased to be that minimal height.~~

Furthermore, in 10.8.1, after the definition of "strut," clarify that the font determines the initial baseline:

The height and depth of the font above and below the baseline are assumed to be metrics that are contained in the font. (For more details, see CSS level 3.)

C.7.58 Section 10.8 Line height calculations: the 'line-height' and 'vertical-align' properties

[2010-08-24] More consistent use of "inline-level" and "block-level."

As described in the section on inline formatting contexts, user agents flow inline-level boxes into a vertical stack of line boxes. The height of a line box is determined as follows:

1. The height of each inline-level box in the line box is calculated (see "Calculating heights and margins" and the 'line-height' property).
2. The inline-level boxes are aligned vertically according to their 'vertical-align' property.

In 10.8.1:

On a ~~block-level, table-cell, table-caption or inline-block~~ block container element whose content is composed of inline-level elements, 'line-height' specifies the minimal height of line boxes within the element. []

On an ~~inline-level~~ element, 'line-height' specifies the height that is used in the calculation of the line box height []

After the definition of 'vertical-align':

The following values only have meaning with respect to a parent ~~inline-level~~ element, or to the strut of a parent ~~block-level, table-cell, table-caption or inline-block~~ block container element.

C.7.59 Section 10.8.1 Leading and half-leading

[2010-07-19] Clarify text:

On a ~~block-level, table-cell, table-caption or inline-block~~ element whose content is composed of inline-level elements, 'line-height' specifies the minimal height of line boxes within the element. The minimum height consists of a minimum height above the ~~block's~~ baseline and a minimum depth below it, exactly as if each line box starts with a zero-width inline box with the ~~block's~~ element's font and line height properties. (what ~~TEX~~ calls a "strut"). We call that imaginary box a "strut." (The name is inspired by TeX.).

C.7.60 Section 10.8.1 Leading and half-leading

[2010-08-20] Remove text that talks about the “content area” of an inline box and about “center vertically” and instead make it more explicit how leading is added to a glyph: leading is added above and below a hypothetical box around each glyph that represents the (normal or ideal) height of a line of text in that font, as given in the font metrics.

Add a note referring to 10.6.1 (which defines that the content area is undefined) and explaining that the exact position of backgrounds and borders relative to the line box is undefined.

Also add a note about how to find the relevant metrics in OpenType and TrueType fonts.

C.7.61 Section 10.8.1 Leading and half-leading

[2010-08-20] Clarify some imprecise terms:

When an element contains text that is rendered in more than one font, user agents may determine the ‘normal’ ‘line-height’ value according to the largest font size.

Generally, when there is only one value of ‘line-height’ for all inline boxes in a paragraph block-level box (and no ~~full images~~ replaced elements, inline-block elements, etc.), the above will ensure that baselines of successive lines are exactly ‘line-height’ apart. This is important when columns of text in different fonts have to be aligned, for example in a table.

C.7.62 Section 11.1 Overflow and clipping

[2010-10-25] Clarify which ancestors are meant:

- A descendant box is positioned absolutely [p. 152], partly outside the box. Such boxes are not always clipped by the overflow property on their ancestors; specifically, they are not clipped by the overflow of any ancestor between themselves and their containing block

C.7.63 Section 11.1.1 Overflow: the ‘overflow’ property

[2010-08-06] The phrase “containing block” in the example doesn’t refer to the technical term “containing block” [p. ??] but simply to the containing box. Change “containing block” to “containing div.”

C.7.64 Section 11.1.1 Overflow: the 'overflow' property

[2010-08-24] More consistent use of "inline-level" and "block-level."

This property specifies whether content of a ~~block-level~~ block container element is clipped when it overflows the element's box.

C.7.65 Section 11.1.1 Overflow: the 'overflow' property

[2010-10-25] Add missing inline-table:

Applies to:	<i>non-replaced block-level elements, table cells, inline-table, and inline-block elements</i>
-------------	--

C.7.66 Section 11.1.2 Clipping: the 'clip' property

[2010-10-25] The computed value of 'auto' is 'auto' also when 'auto' is specified inside 'rect()':

Computed value:	<i>For rectangle values, a rectangle consisting of four computed lengths; otherwise, as specified 'auto' if specified as 'auto', otherwise a rectangle with four values, each of which is 'auto' if specified as 'auto' and the computed length otherwise</i>
-----------------	--

And:

<top>, <right>, <bottom>, and <left> may either have a <length> value or 'auto'. Negative lengths are permitted. The value 'auto' means that a given edge of the clipping region will be the same as the edge of the element's generated border box (i.e., 'auto' means the same as '0' for <top> and <left> (in left-to-right text, <right> in right-to-left text), the same as the ~~computed~~ used value of the height plus the sum of vertical padding and border widths for <bottom>, and the same as the ~~computed~~ used value of the width plus the sum of the horizontal padding and border widths for <right> (in left-to-right text, <left> in right-to-left text), such that four 'auto' values result in the clipping region being the same as the element's border box).

C.7.67 Section 12.5 Lists

[2010-10-05] Improve wording: the marker box of a list item isn't "optional," it is sometimes absent. Change:

CSS 2.1 offers basic visual formatting of lists. An element with 'display: list-item' generates a principal box for the element's content ~~and an optional marker box~~ and, depending on the values of 'list-style-type' and 'list-style-image', possibly also a marker box as a visual indication that the

element is a list item.

C.7.68 Section 12.5.1 Lists: the *'list-style-type'*, *'list-style-image'*, *'list-style-position'*, and *'list-style'* properties

[2010-07-14] Because of persistent incompatibilities between implementations, the constraints on the position of *'outside'* markers are relaxed in the presence of floats. This will be fixed in a future specification.

C.7.69 Section 12.5.1 Lists: the *'list-style-type'*, *'list-style-image'*, *'list-style-position'*, and *'list-style'* properties

[2010-08-06] The *'armenian'* *list-style-type* refers to uppercase Armenian numbering.

C.7.70 Section 12.5.1 Lists: the *'list-style-type'*, *'list-style-image'*, *'list-style-position'*, and *'list-style'* properties

[2010-08-06] Define the order of *'inside'* marker boxes and *':before'* pseudo-elements:

inside

The marker box is placed as the first inline box in the principal block box, after which the element's content flows before the element's content and before any *':before'* pseudo-elements.

C.7.71 Section 12.5.1 Lists: the *'list-style-type'*, *'list-style-image'*, *'list-style-position'*, and *'list-style'* properties

[2010-08-06] CSS 2.1 does not specify the precise location of an *'outside'* marker box, including its z-order. Append:

CSS 2.1 does not specify the precise location of the marker box or its position in the painting order

C.7.72 Section 12.5.1 Lists: the *'list-style-type'*, *'list-style-image'*, *'list-style-position'*, and *'list-style'* properties

[2010-11-25] Because of historical ambiguity, CSS level 2 does not yet require the marker to be visible when *'list-style-position'* is *'outside'* and *'overflow'* is other than *'visible'*. Insert in the definition of *'outside'*:

In CSS 2.1, a UA may hide the marker if the element's *'overflow'* is other than *'visible'*. (This is expected to change in the future.)

C.7.73 Section 13.2 Page boxes: the @page rule

[2010-07-07] The @page rule can contain not just declarations but also other @-rules. (There aren't any such nested @-rules defined in level 2, but there are in level 3.)

An @page rule consists of the keyword "@page", followed by an optional page selector, followed by a block of declarations containing declarations and at-rules.

Note: CSS level 2 has no at-rules that may appear inside @page, but such at-rules are expected to be defined in level 3.

And add just above section 13.2.1:

The rules for handling malformed declarations, malformed statements, and invalid at-rules inside @page are as defined in section 4.2, with the following addition: when the UA expects the start of a declaration or at-rule (i.e., an IDENT token or an ATKEYWORD token) but finds an unexpected token instead, that token is considered to be the first token of a malformed declaration. I.e., the rule for malformed declarations, rather than malformed statements is used to determine which tokens to ignore in that case.

C.7.74 Section 13.2.2 Page selectors: selecting left, right, and first pages

[2010-10-25] Whether the first page of a document is :left or :right depends on the major writing direction. Give an example of how:

All pages are automatically classified by user agents into either the :left or :right pseudo-class. Whether the first page of a document is :left or :right depends on the major writing direction of the root element. For example, the first page of a document with a left-to-right major writing direction would be a :right page, and the first page of a document with a right-to-left major writing direction would be a :left page. To explicitly force a document to begin printing on a left or right page, authors can insert a page break before the first generated box.

And in 13.3.1:

~~Whether the first page of a document is :left or :right depends on the major writing direction of the document.~~

C.7.75 Section 13.3.2 Breaks inside elements: 'orphans', 'widows'

[2010-08-24] More consistent use of “inline-level” and “block-level.” Change for both ‘orphans’ and ‘widows’:

Applies to: ~~block-level~~ block container elements

And change:

The ‘orphans’ property specifies the minimum number of lines in a block element container that must be left at the bottom of a page. The ‘widows’ property specifies the minimum number of lines in a block element container that must be left at the top of a page. Examples of how they are used to control page breaks are given below.

C.7.76 Section 13.3.3 Allowed page breaks

[2010-08-24] More consistent use of “inline-level” and “block-level.” Change:

1. In the vertical margin between block-level boxes. [□]
2. Between line boxes inside a block container box.
3. Between the content edge of a block container box and the outer edges of its child content [□]

C.7.77 Section 15.3 Font family: the ‘font-family’ property

[2010-07-19] The specification was ambiguous as to whether parentheses, brackets and braces in font names must always be escaped, or only when needed to conform to the syntax for declarations. Because of that, and because of the many bugs in implementations, all font names must now either be quoted, or be escaped so as to consist of only identifiers.

C.7.78 Section 15.3.1 Generic font families

[2010-08-26] Make it clearer that CSS does not try to define what fonts are serif or sans-serif:

15.3.1.1 serif

Glyphs of serif fonts, as the term is used in CSS, tend to have finishing strokes, flared or tapering ends, or have actual serified endings (including slab serifs). [□]

15.3.1.2 sans-serif

Glyphs in sans-serif fonts, as the term is used in CSS, tend to have stroke endings that are plain – *without any* with little or no flaring, cross stroke, or other ornamentation. [□]

C.7.79 Section 15.6 Font boldness: the 'font-weight' property

[2010-04-19] The meaning of the keywords 'bolder' and 'lighter' no longer depends on both the inherited weight and the actually used font, but only on the inherited weight.

C.7.80 Section 15.6 Font boldness: the 'font-weight' property

[2010-10-13] Clarify the algorithm for mapping CSS font weight values to the actual weights of a font and make it normative:

The association of other weights within a family to the numerical weight values is intended only to preserve the ordering of darkness within that family. However, the following heuristics tell how the assignment is done in typical cases:

- If the font family already uses a numerical scale with nine values (like e.g., OpenType does), the font weights should be mapped directly.
- If there is both a face labeled Medium and one labeled Book, Regular, Roman or Normal, then the Medium is normally assigned to the '500'.
- The font labeled "Bold" will often correspond to the weight value '700'.

Once the font family's weights are mapped onto the CSS scale, missing weights are selected as follows:

- ~~If there are fewer than 9 weights in the family, the default algorithm for filling the "holes" is as follows. If '500' is unassigned, it will be assigned the same font as '400'. If any of the values '600', '700', '800' or '900' remains unassigned, they are assigned to the same face as the next darker assigned keyword, if any, or the next lighter one otherwise. If any of '300', '200' or '100' remains unassigned, it is assigned to the next lighter assigned keyword, if any, or the next darker otherwise.~~
- If the desired weight is less than 400, weights below the desired weight are checked in descending order followed by weights above the desired weight in ascending order until a match is found.
- If the desired weight is greater than 500, weights above desired weight are checked in ascending order followed by weights below the desired weight in descending order until a match is found.
- If the desired weight is 400, 500 is checked first and then the rule for desired weights less than 400 is used.
- If the desired weight is 500, 400 is checked first and then the rule for desired weights less than 400 is used.

C.7.81 Section 15.7 Font size: the 'font-size' property

[2010-08-06] Changed "Percentages: refer to parent element's font size" to "Percentages: refer to inherited font size" so that it uses the same terminology as Section 4.3.3. [p. ??]

C.7.82 Section 16.1 Indentation: the 'text-indent' property

[2010-08-24] More consistent use of “inline-level” and “block-level.” Change:

Applies to: ~~block-level elements, table cells and inline blocks~~ block containers

[]

This property specifies the indentation of the first line of text in a block container.

C.7.83 Section 16.1 Indentation: the 'text-indent' property

[2010-10-25] Clarify that the “first line” of the “first box,” etc., is the same as the “first formatted line” of chapter 5:

'Text-indent' only affects a line if it is the first formatted line of an element. For example, the first line of an anonymous block box is only affected if it is the first child of its parent element.

C.7.84 Section 16.2 Alignment: the 'text-align' property

[2010-07-19] The value 'pre-line' of 'white-space' does not inhibit justification. (Only lines that end with an explicit newline aren't justified, as is the case for any value of 'white-space'.) But, 'pre-wrap' does inhibit justification. Replace

~~If the computed value of text-align is 'justify' while the computed value of white-space is 'pre' or 'pre-line', the actual value of text-align is set to the initial value.~~

with

If an element has a computed value for 'white-space' of 'pre' or 'pre-wrap', then neither the glyphs of that element's text content nor its white space may be altered for the purpose of justification.

C.7.85 Section 16.2 Alignment: the 'text-align' property

[2010-08-24] More consistent use of “inline-level” and “block-level.” Change:

Applies to: ~~block-level elements, table cells and inline blocks~~ block containers

This property describes how inline-level content of a block container is aligned.

And:

~~[] In the case of 'left', 'right' and 'center', this property specifies how the inline-level boxes within each line box align with respect to the line box's left and right sides; alignment is not with respect to the viewport. In the case of 'justify', this property specifies that the inline-level boxes are to be made flush with both sides of the block container if possible, by expanding or contracting the contents of inline boxes, else aligned as for the initial value.~~

C.7.86 Section 16.3.1 Underlining, overlining, striking, and blinking: the 'text-decoration' property

[2010-08-24] Clarify that 'text-decoration' does not propagate to inline-table and inline-block elements. Change:

~~This property describes decorations that are added to the text of an element using the element's color. When specified on an inline element, it affects all the boxes generated by that element; for all other elements, the decorations are propagated to an anonymous inline box that wraps all the in-flow inline children of the element, and to any block-level in-flow descendants. It is not, however, further propagated to floating and absolutely positioned descendants, nor to the contents of 'inline-table' and 'inline-block' descendants. or propagated to an inline element, it affects all the boxes generated by that element, and is further propagated to any in-flow block-level boxes that split the inline (see section 9.2.1.1). For block containers that establish an inline formatting context, the decorations are propagated to an anonymous inline element that wraps all the in-flow inline-level children of the block container. For all other elements it is propagated to any in-flow children. Note that text decorations are not propagated to floating and absolutely positioned descendants, nor to the contents of atomic inline-level descendants such as inline blocks and inline tables.~~

and:

~~If an element contains no text, user agents must refrain from rendering these text decorations on the element. For example, images will not be underlined. User agents must not render these text decorations on content that is not text. For example, images and inline blocks must not be underlined.~~

C.7.87 Section 16.3.1 Underlining, overlining, striking, and blinking: the 'text-decoration' property

[2010-10-05] CSS 2.1 does not specify if a text decoration that is specified on a transparent element ('visibility: hidden') is itself transparent, or only transparent where the text is transparent. Add this note:

Note. If an element E has both 'visibility: hidden' and 'text-decoration: underline', the underline is invisible (although any decoration of E's parent **is** visible.) However, CSS 2.1 does not specify if the underline is visible or invisible in E's children:

```
<span style="visibility: hidden; text-decoration: underline">
  <span style="visibility: visible">
    underlined or not?
  </span>
</span>
```

This is expected to be specified in level 3 of CSS.

C.7.88 Section 16.4 Letter and word spacing: the 'letter-spacing' and 'word-spacing' properties

[2010-04-19] *Word spacing does not affect fixed-width spaces. Change:*

Word spacing affects each space (U+0020), and non-breaking space (U+00A0) and ideographic space (U+3000), left in the text after the white space processing rules have been applied. The effect of the property on other word-separator characters is undefined. However general punctuation, characters with zero advance width (such as the zero with space U+200B) and fixed-width spaces (such as U+3000 and U+2000 through U+200A) are not affected.

C.7.89 Section 16.6 White space: the 'white-space' property

[2010-10-25] *If the document language specifies how newlines are represented, those newlines must be passed to the CSS UA as line feed (LF) characters. If the document language does not define how newlines are expressed (e.g., if text is inserted with the 'content' property), the CSS UA must treat CR, and CRLF as if they were LF:*

Newlines in the source can be represented by a carriage return (U+000D), a linefeed (U+000A) or both (U+000D U+000A) or by some other mechanism that identifies the beginning and end of document segments, such as the SGML RECORD-START and RECORD-END tokens. The CSS 'white-space' processing model assumes all newlines have been normalized to line feeds. UAs that recognize other newline representations must apply the white space processing rules as if this normalization has taken place. If no newline rules are specified for the document language, each carriage return (U+000D) and CRLF sequence (U+000D U+000A) in the document text is treated as single line feed character. This default normalization rule also applies to generated content.

[]

1. Each tab (U+0009), ~~carriage return (U+000D)~~, or space (U+0020) character surrounding a linefeed (U+000A) character is removed if 'white-space' is set to 'normal', 'nowrap', or 'pre-line'.

C.7.90 Section 16.6.1 The 'white-space' processing model

[2010-08-06] The sentence that absolutely positioned elements do not create line breaking opportunities is normative, not informative.

C.7.91 Section 16.6.1 The 'white-space' processing model

[2010-08-06] The first paragraph is moved to 9.2.2.1. Also, as is clear from the latter section, the "should" is a "must":

Any text that is directly contained inside a block container element (not inside an inline element) ~~should~~ must be treated as an anonymous inline element.

C.7.92 Section 16.6.1 The 'white-space' processing model

[2010-08-24] More consistent use of "inline-level" and "block-level." Change:

Then, the ~~entire block is rendered~~ block container's inlines are laid out.

C.7.93 Section 17.2 The CSS table model

[2010-08-04] Clarify that the term "row group" includes header groups and footer groups as well:

Thus, the table model consists of tables, captions, rows, row groups (including header groups and footer groups), columns, column groups, and cells.

C.7.94 Section 17.2.1 Anonymous table objects

[2010-08-24] XML and HTML5, unlike SGML, do not automatically remove insignificant white space. Change the rules for generating anonymous table elements to suppress most white space between elements, rather than consider it the content of an anonymous table cell.

C.7.95 Section 17.2.1 Anonymous table objects

[2010-08-24] The static position of absolutely positioned elements between table cells or rows was not very useful. Define that the static position of such an element is found not just as if the element had 'position: static', but also had 'display: inline' and zero width and height.

C.7.96 Section 17.4 Tables in the visual formatting model

[2010-04-19] The caption of the image still describes the image as it was in the previous version. Change:

~~Diagram of a table with a caption above it; the top margin of the caption is collapsed with the top margin of the table.~~

C.7.97 Section 17.4 Tables in the visual formatting model

[2010-10-13] Clarify which of the two boxes generated by a table element is the principal box:

In both cases, the table box generates an anonymous box a principal block box called the table wrapper box that contains the table box itself and any caption boxes (in document order). The table box is a block-level box that contains the table's internal table boxes. The caption boxes are block-level boxes that retain their own content, padding, margin, and border areas, and are rendered as normal blocks block boxes inside the anonymous table wrapper box. Whether the caption boxes are placed before or after the table box is decided by the 'caption-side' property, as described below.

The anonymous table wrapper box is a 'block' box if the table is block-level, and an 'inline-block' box if the table is inline-level. The anonymous table wrapper box establishes a block formatting context. The table box (not the anonymous table wrapper box) is used when doing baseline vertical alignment for an 'inline-table'. The width of the anonymous table wrapper box is the border-edge width of the table box inside it, as described by section 17.5.2. Percentages on 'width' and 'height' on the table are relative to the anonymous table wrapper box's containing block, not the anonymous table wrapper box itself.

The computed values of properties 'position', 'float', 'margin-*', 'top', 'right', 'bottom', and 'left' on the table box are used on the anonymous table wrapper box instead of the table box. The table box uses the initial values for those properties.

C.7.98 Section 17.5.2.2 Automatic table layout

[2010-10-25] The width of the table caption contributes to the width of the table if 'table-layout' is 'auto':

This gives a maximum and minimum width for each column.

The caption width minimum (CAPMIN) is determined by calculating for each caption the minimum caption outer width as the MCW of a hypothetical table cell that contains the caption formatted as "display: block". The greatest of the minimum caption outer widths is CAPMIN.

Column and caption widths influence the final table width as follows:

1. If the 'table' or 'inline-table' element's 'width' property has a computed value (W) other than 'auto', the ~~property's value as used for layout~~ used width is the greater of W , CAPMIN, and the minimum width required by all the columns plus cell spacing or borders (MIN). If ~~W~~ the used width is greater

than MIN, the extra width should be distributed over the columns.

2. If the 'table' or 'inline-table' element has 'width: auto', the ~~table width used for layout~~ used width is the greater of the table's containing block width, CAPMIN, and MIN. However, if either CAPMIN or the maximum width required by the columns plus cell spacing or borders (MAX) is less than that of the containing block, use ~~MAX~~ $\max(\text{MAX}, \text{CAPMIN})$.

C.7.99 Section 17.5.3 Table height algorithms

[2010-07-15] Clarify that the height of a table row can be influenced by 'vertical-align' and 'height', but the content box of the table cell is not affected.

[\square] it is the maximum of the row's specified 'height', the specified 'height' of each cell in the row, and the minimum height (MIN) required by the cells

and

In CSS 2.1, the height of a cell box is the ~~maximum of the table cell's 'height' property and the minimum height required by the content (MIN)~~: minimum height required by the content. The table cell's 'height' property can influence the height of the row, but it does not increase the height of the cell box. A value of 'auto' for 'height' implies that the value MIN will be used for layout.

C.7.100 Section 17.5.4 Horizontal alignment in a column

[2010-08-24] More consistent use of "inline-level." Change:

The horizontal alignment of a ~~cell's inline content~~ inline-level content within a cell box

C.7.101 Section B.2 Informative references

[2010-08-06] BCP 47 replaces RFC 3066.

C.7.102 Section D. Default style sheet for HTML 4

[2010-10-05] HTML defines that HTML's block elements represent a Unicode embedding even if they are displayed inline by means of a style sheet. The default style sheet for HTML didn't yet express that. Add:

```
html, address,
blockquote,
body, dd, div,
dl, dt, fieldset, form,
frame, frameset,
h1, h2, h3, h4,
h5, h6, noframes,
ol, p, ul, center,
dir, hr, menu, pre { display: block; unicode-bidi: embed }
```

C.7.103 Section E.2 Painting order

[2010-07-07] Clarification:

- █ The ~~stacking order~~ for painting order for the descendants of an element generating a stacking context (see the 'z-index' property) is: [□]

C.7.104 Appendix G Grammar of CSS 2.1

[2010-10-25] The appendix is not normative.

Appendix D. Default style sheet for HTML 4

This appendix is informative, not normative.

This style sheet describes the typical formatting of all HTML 4 ([HTML4]) elements based on extensive research into current UA practice. Developers are encouraged to use it as a default style sheet in their implementations.

The full presentation of some HTML elements cannot be expressed in CSS 2.1, including replaced [p. 44] elements ("img", "object"), scripting elements ("script", "applet"), form control elements, and frame elements.

For other elements, the legacy presentation can be described in CSS but the solution removes the element. For example, the FONT element can be replaced by attaching CSS declarations to other elements (e.g., DIV). Likewise, legacy presentation of presentational attributes (e.g., the "border" attribute on TABLE) can be described in CSS, but the markup in the source document must be changed.

```
html, address,
blockquote,
body, dd, div,
dl, dt, fieldset, form,
frame, frameset,
h1, h2, h3, h4,
h5, h6, noframes,
ol, p, ul, center,
dir, hr, menu, pre { display: block; unicode-bidi: embed }
li { display: list-item }
head { display: none }
table { display: table }
tr { display: table-row }
thead { display: table-header-group }
tbody { display: table-row-group }
tfoot { display: table-footer-group }
col { display: table-column }
colgroup { display: table-column-group }
td, th { display: table-cell }
caption { display: table-caption }
th { font-weight: bolder; text-align: center }
caption { text-align: center }
body { margin: 8px }
h1 { font-size: 2em; margin: .67em 0 }
h2 { font-size: 1.5em; margin: .75em 0 }
h3 { font-size: 1.17em; margin: .83em 0 }
h4, p,
blockquote, ul,
fieldset, form,
ol, dl, dir,
menu { margin: 1.12em 0 }
h5 { font-size: .83em; margin: 1.5em 0 }
h6 { font-size: .75em; margin: 1.67em 0 }
h1, h2, h3, h4,
h5, h6, b,
```

Default style sheet for HTML 4

```
strong          { font-weight: bolder }
blockquote     { margin-left: 40px; margin-right: 40px }
i, cite, em,
var, address   { font-style: italic }
pre, tt, code,
kbd, samp     { font-family: monospace }
pre           { white-space: pre }
button, textarea,
input, select  { display: inline-block }
big           { font-size: 1.17em }
small, sub, sup { font-size: .83em }
sub          { vertical-align: sub }
sup         { vertical-align: super }
table       { border-spacing: 2px; }
thead, tbody,
tfoot      { vertical-align: middle }
td, th, tr { vertical-align: inherit }
s, strike, del { text-decoration: line-through }
hr         { border: 1px inset }
ol, ul, dir,
menu, dd   { margin-left: 40px }
ol        { list-style-type: decimal }
ol ul, ul ol,
ul ul, ol ol { margin-top: 0; margin-bottom: 0 }
u, ins    { text-decoration: underline }
br:before { content: "\A"; white-space: pre-line }
center    { text-align: center }
:link, :visited { text-decoration: underline }
:focus    { outline: thin dotted invert }

/* Begin bidirectionality settings (do not change) */
BDO[DIR="ltr"] { direction: ltr; unicode-bidi: bidi-override }
BDO[DIR="rtl"] { direction: rtl; unicode-bidi: bidi-override }

*[DIR="ltr"] { direction: ltr; unicode-bidi: embed }
*[DIR="rtl"] { direction: rtl; unicode-bidi: embed }

@media print {
  h1 { page-break-before: always }
  h1, h2, h3,
  h4, h5, h6 { page-break-after: avoid }
  ul, ol, dl { page-break-before: avoid }
}
```

Appendix E. Elaborate description of Stacking Contexts

Contents

E.1 Definitions	437
E.2 Painting order	437
E.3 Notes	440

This chapter defines the CSS 2.1 painting order in more detail than described in the rest of the specification.

E.1 Definitions

Tree Order

Preorder depth-first traversal of the *rendering tree*, in logical (not visual) order for bidirectional content, after taking into account properties that move boxes around such as the 'run-in' value of 'display'.

Element

In this description, "element" refers to actual elements, pseudo-elements, and anonymous boxes. Pseudo-elements and anonymous boxes are treated as descendants in the appropriate places. For example, an outside list marker comes before an adjoining ':before' box in the line box, which comes before the content of the box, and so forth.

E.2 Painting order

The bottom of the stack is the furthest from the user, the top of the stack is the nearest to the user:

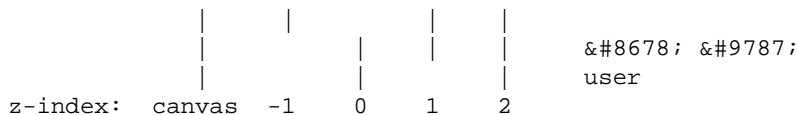

The stacking context background and most negative positioned stacking contexts are at the bottom of the stack, while the most positive positioned stacking contexts are at the top of the stack.

The canvas is transparent if contained within another, and given a UA-defined color if it is not. It is infinite in extent and contains the root element. Initially, the viewport is anchored with its top left corner at the canvas origin.

The painting order for the descendants of an element generating a stacking context (see the 'z-index' property) is:

1. If the element is a root element:
 1. background color of element over the entire canvas.
 2. background image of element, over the entire canvas, anchored at the origin that would be used if it was painted for the root element.
2. If the element is a block, list-item, or other block equivalent:
 1. background color of element unless it is the root element.
 2. background image of element unless it is the root element.
 3. border of element.

Otherwise, if the element is a block level table:

 1. table backgrounds (color then image) unless it is the root element.
 2. column group backgrounds (color then image).
 3. column backgrounds (color then image).
 4. row group backgrounds (color then image).
 5. row backgrounds (color then image).
 6. cell backgrounds (color then image).
 7. all table borders (in tree order for separated borders).
3. Stacking contexts formed by positioned descendants with negative z-indices (excluding 0) in z-index order (most negative first) then tree order.
4. For all its in-flow, non-positioned, block-level descendants in tree order: If the element is a block, list-item, or other block equivalent:
 1. background color of element.
 2. background image of element.
 3. border of element.

Otherwise, the element is a table:

 1. table backgrounds (color then image).
 2. column group backgrounds (color then image).
 3. column backgrounds (color then image).
 4. row group backgrounds (color then image).
 5. row backgrounds (color then image).
 6. cell backgrounds (color then image).
 7. all table borders (in tree order for separated borders).
5. All non-positioned floating descendants, in tree order. For each one of these, treat the element as if it created a new stacking context, but any positioned descendants and descendants which actually create a new stacking context should be considered part of the parent stacking context, not this new one.
6. If the element is an inline element that generates a stacking context, then:
 1. For each line box that the element is in:
 1. Jump to 7.2.1 [p. 439] for the box(es) of the element in that line box (in tree order).

7. Otherwise: first for the element, then for all its in-flow, non-positioned, block-level descendants in tree order:
 1. If the element is a block-level replaced element, then: the replaced content, atomically.
 2. Otherwise, for each line box of that element:
 - 1.

For each box that is a child of that element, in that line box, in tree order:

1. background color of element.
2. background image of element.
3. border of element.
4. For inline elements:
 1. For all the element's in-flow, non-positioned, inline-level children that are in this line box, and all runs of text inside the element that is on this line box, in tree order:
 1. If this is a run of text, then:
 1. any underlining affecting the text of the element, in tree order of the elements applying the underlining (such that the deepest element's underlining, if any, is painted topmost and the root element's underlining, if any, is drawn bottommost).
 2. any overlining affecting the text of the element, in tree order of the elements applying the overlining (such that the deepest element's overlining, if any, is painted topmost and the root element's overlining, if any, is drawn bottommost).
 3. the text.
 4. any line-through affecting the text of the element, in tree order of the elements applying the line-through (such that the deepest element's line-through, if any, is painted topmost and the root element's line-through, if any, is drawn bottommost).
 2. Otherwise, jump to 7.2.1 [p. 439] for that element.

For inline-block and inline-table elements:

1. For each one of these, treat the element as if it created a new stacking context, but any positioned descendants and descendants which actually create a new stacking context should be considered part of the parent stacking context, not this new one.

For inline-level replaced elements:

1. the replaced content, atomically.

Some of the boxes may have been generated by line splitting or the Unicode bidirectional algorithm.

2. Optionally, the outline of the element (see 10 below [p. 440]).
3. Optionally, if the element is block-level, the outline of the element (see 10 below [p. 440]).
8. All positioned descendants with 'z-index: auto' or 'z-index: 0', in tree order. For those with 'z-index: auto', treat the element as if it created a new stacking context, but any positioned descendants and descendants which actually create a new stacking context should be considered part of the parent stacking context, not this new one. For those with 'z-index: 0', treat the stacking context generated atomically.
9. Stacking contexts formed by positioned descendants with z-indices greater than or equal to 1 in z-index order (smallest first) then tree order.
- 10.

Finally, implementations that do not draw outlines in steps above must draw outlines from this stacking context at this stage. (It is recommended to draw outlines in this step and not in the steps above.)

E.3 Notes

The background of the root element is only painted once, over the whole canvas.

While the backgrounds of bidirectional inlines are painted in tree order, they are positioned in visual order. Since the positioning of inline backgrounds is unspecified in CSS 2.1, the exact result of these two requirements is UA-defined. CSS3 may define this in more detail.

Appendix F. Full property table

This appendix is informative, not normative.

Name	Values	Initial value	Applies to (Default: all)	Inherited?	Percentages (Default: N/A)	Media groups
'azimuth' [p. 314]	<angle> [[left-side far-left left center-left center center-right right far-right right-side] behind] leftwards rightwards inherit	center		yes		aural [p. 305]
'background-attachment' [p. 235]	scroll fixed inherit	scroll		no		visual [p. 110]
'background-color' [p. 232]	<color> transparent inherit	transparent		no		visual [p. 110]
'background-image' [p. 233]	<uri> none inherit	none		no		visual [p. 110]
'background-position' [p. 236]	[[[<percentage> <length> left center right] [<percentage> <length> top center bottom]?] [[left center right] [top center bottom]] inherit	0% 0%		no	refer to the size of the box itself	visual [p. 110]
'background-repeat' [p. 234]	repeat repeat-x repeat-y no-repeat inherit	repeat		no		visual [p. 110]
'background' [p. 237]	['background-color' 'background-image' 'background-repeat' 'background-attachment' 'background-position'] inherit	see individual properties		no	allowed on 'background-position'	visual [p. 110]
'border-collapse' [p. 288]	collapse separate inherit	separate	'table' and 'inline-table' elements	yes		visual [p. 110]
'border-color' [p. 122]	[<color> transparent]{1,4} inherit	see individual properties		no		visual [p. 110]
'border-spacing' [p. 288]	<length> <length>? inherit	0	'table' and 'inline-table' elements	yes		visual [p. 110]
'border-style' [p. 124]	<border-style>{1,4} inherit	see individual properties		no		visual [p. 110]
'border-top' [p. 124] 'border-right' [p. 124] 'border-bottom' [p. 124] 'border-left' [p. 124]	[<border-width> <border-style> 'border-top-color'] inherit	see individual properties		no		visual [p. 110]
'border-top-color' [p. 121] 'border-right-color' [p. 121] 'border-bottom-color' [p. 121] 'border-left-color' [p. 121]	<color> transparent inherit	the value of the 'color' property		no		visual [p. 110]

Full property table

Name	Values	Initial value	Applies to (Default: all)	Inherited?	Percentages (Default: N/A)	Media groups
'border-top-style' [p. 123] 'border-right-style' [p. 123] 'border-bottom-style' [p. 123] 'border-left-style' [p. 123]	<border-style> inherit	none		no		visual [p. 110]
'border-top-width' [p. 120] 'border-right-width' [p. 120] 'border-bottom-width' [p. 120] 'border-left-width' [p. 120]	<border-width> inherit	medium		no		visual [p. 110]
'border-width' [p. 121]	<border-width>{1,4} inherit	see individual properties		no		visual [p. 110]
'border' [p. 125]	[<border-width> <border-style> 'border-top-color'] inherit	see individual properties		no		visual [p. 110]
'bottom' [p. 137]	<length> <percentage> auto inherit	auto	positioned elements	no	refer to height of containing block	visual [p. 110]
'caption-side' [p. 277]	top bottom inherit	top	'table-caption' elements	yes		visual [p. 110]
'clear' [p. 149]	none left right both inherit	none	block-level elements	no		visual [p. 110]
'clip' [p. 198]	<shape> auto inherit	auto	absolutely positioned elements	no		visual [p. 110]
'color' [p. 231]	<color> inherit	depends on user agent		yes		visual [p. 110]
'content' [p. 205]	normal none [<string> <uri> <counter> attr(<identifier>) open-quote close-quote no-open-quote no-close-quote]+ inherit	normal	:before and :after pseudo-elements	no		all [p. 110]
'counter-increment' [p. 210]	[<identifier> <integer>?]+ none inherit	none		no		all [p. 110]
'counter-reset' [p. 210]	[<identifier> <integer>?]+ none inherit	none		no		all [p. 110]
'cue-after' [p. 311]	<uri> none inherit	none		no		aural [p. 305]
'cue-before' [p. 311]	<uri> none inherit	none		no		aural [p. 305]
'cue' [p. 312]	['cue-before' 'cue-after'] inherit	see individual properties		no		aural [p. 305]

Full property table

Name	Values	Initial value	Applies to (Default: all)	Inherited?	Percentages (Default: N/A)	Media groups
'cursor' [p. 297]	[[<uri> ,]* [auto crosshair default pointer move e-resize ne-resize nw-resize n-resize se-resize sw-resize s-resize w-resize text wait help progress]] inherit	auto		yes		visual [p. 110] , interactive [p. 110]
'direction' [p. 167]	ltr rtl inherit	ltr	all elements, but see prose	yes		visual [p. 110]
'display' [p. 133]	inline block list-item run-in inline-block table inline-table table-row-group table-header-group table-footer-group table-row table-column-group table-column table-cell table-caption none inherit	inline		no		all [p. 110]
'elevation' [p. 315]	<angle> below level above higher lower inherit	level		yes		aural [p. 305]
'empty-cells' [p. 290]	show hide inherit	show	'table-cell' elements	yes		visual [p. 110]
'float' [p. 147]	left right none inherit	none	all, but see 9.7 [p. 154]	no		visual [p. 110]
'font-family' [p. 242]	[[<family-name> <generic-family>] [, <family-name> <generic-family>]*] inherit	depends on user agent		yes		visual [p. 110]
'font-size' [p. 251]	<absolute-size> <relative-size> <length> <percentage> inherit	medium		yes	refer to inherited font size	visual [p. 110]
'font-style' [p. 247]	normal italic oblique inherit	normal		yes		visual [p. 110]
'font-variant' [p. 247]	normal small-caps inherit	normal		yes		visual [p. 110]
'font-weight' [p. 248]	normal bold bolder lighter 100 200 300 400 500 600 700 800 900 inherit	normal		yes		visual [p. 110]
'font' [p. 253]	[['font-style' 'font-variant' 'font-weight']? 'font-size' [/ 'line-height']? 'font-family'] caption icon menu message-box small-caption status-bar inherit	see individual properties		yes	see individual properties	visual [p. 110]
'height' [p. 182]	<length> <percentage> auto inherit	auto	all elements but non-replaced inline elements, table columns, and column groups	no	see prose	visual [p. 110]
'left' [p. 138]	<length> <percentage> auto inherit	auto	positioned elements	no	refer to width of containing block	visual [p. 110]

Full property table

Name	Values	Initial value	Applies to (Default: all)	Inherited?	Percentages (Default: N/A)	Media groups
'letter-spacing' [p. 262]	normal <length> inherit	normal		yes		visual [p. 110]
'line-height' [p. 191]	normal <number> <length> <percentage> inherit	normal		yes	refer to the font size of the element itself	visual [p. 110]
'list-style-image' [p. 216]	<uri> none inherit	none	elements with 'display: list-item'	yes		visual [p. 110]
'list-style-position' [p. 217]	inside outside inherit	outside	elements with 'display: list-item'	yes		visual [p. 110]
'list-style-type' [p. 215]	disc circle square decimal decimal-leading-zero lower-roman upper-roman lower-greek lower-latin upper-latin armenian georgian lower-alpha upper-alpha none inherit	disc	elements with 'display: list-item'	yes		visual [p. 110]
'list-style' [p. 219]	['list-style-type' 'list-style-position' 'list-style-image'] inherit	see individual properties	elements with 'display: list-item'	yes		visual [p. 110]
'margin-right' [p. 116] 'margin-left' [p. 116]	<margin-width> inherit	0	all elements except elements with table display types other than table-caption, table and inline-table	no	refer to width of containing block	visual [p. 110]
'margin-top' [p. 115] 'margin-bottom' [p. 115]	<margin-width> inherit	0	all elements except elements with table display types other than table-caption, table and inline-table	no	refer to width of containing block	visual [p. 110]
'margin' [p. 116]	<margin-width>{1,4} inherit	see individual properties	all elements except elements with table display types other than table-caption, table and inline-table	no	refer to width of containing block	visual [p. 110]
'max-height' [p. 188]	<length> <percentage> none inherit	none	all elements but non-replaced inline elements, table columns, and column groups	no	see prose	visual [p. 110]
'max-width' [p. 180]	<length> <percentage> none inherit	none	all elements but non-replaced inline elements, table rows, and row groups	no	refer to width of containing block	visual [p. 110]
'min-height' [p. 188]	<length> <percentage> inherit	0	all elements but non-replaced inline elements, table columns, and column groups	no	see prose	visual [p. 110]
'min-width' [p. 180]	<length> <percentage> inherit	0	all elements but non-replaced inline elements, table rows, and row groups	no	refer to width of containing block	visual [p. 110]

Full property table

Name	Values	Initial value	Applies to (Default: all)	Inherited?	Percentages (Default: N/A)	Media groups
'orphans' [p. 227]	<integer> inherit	2	block container elements	yes		visual [p. 110] , paged [p. 110]
'outline-color' [p. 301]	<color> invert inherit	invert		no		visual [p. 110] , interactive [p. 110]
'outline-style' [p. 301]	<border-style> inherit	none		no		visual [p. 110] , interactive [p. 110]
'outline-width' [p. 301]	<border-width> inherit	medium		no		visual [p. 110] , interactive [p. 110]
'outline' [p. 300]	['outline-color' 'outline-style' 'outline-width'] inherit	see individual properties		no		visual [p. 110] , interactive [p. 110]
'overflow' [p. 195]	visible hidden scroll auto inherit	visible	non-replaced block-level elements, table cells, inline-table, and inline-block elements	no		visual [p. 110]
'padding-top' [p. 119] 'padding-right' [p. 119] 'padding-bottom' [p. 119] 'padding-left' [p. 119]	<padding-width> inherit	0	all elements except table-row-group, table-header-group, table-footer-group, table-row, table-column-group and table-column	no	refer to width of containing block	visual [p. 110]
'padding' [p. 119]	<padding-width>{1,4} inherit	see individual properties	all elements except table-row-group, table-header-group, table-footer-group, table-row, table-column-group and table-column	no	refer to width of containing block	visual [p. 110]
'page-break-after' [p. 226]	auto always avoid left right inherit	auto	block-level elements (but see text)	no		visual [p. 110] , paged [p. 110]
'page-break-before' [p. 225]	auto always avoid left right inherit	auto	block-level elements (but see text)	no		visual [p. 110] , paged [p. 110]
'page-break-inside' [p. 226]	avoid auto inherit	auto	block-level elements (but see text)	no		visual [p. 110] , paged [p. 110]
'pause-after' [p. 310]	<time> <percentage> inherit	0		no	see prose	aural [p. 305]
'pause-before' [p. 310]	<time> <percentage> inherit	0		no	see prose	aural [p. 305]
'pause' [p. 310]	[[<time> <percentage>]{1,2}] inherit	see individual properties		no	see descriptions of 'pause-before' and 'pause-after'	aural [p. 305]
'pitch-range' [p. 318]	<number> inherit	50		yes		aural [p. 305]

Full property table

Name	Values	Initial value	Applies to (Default: all)	Inherited?	Percentages (Default: N/A)	Media groups
'pitch' [p. 317]	<frequency> x-low low medium high x-high inherit	medium		yes		aural [p. 305]
'play-during' [p. 312]	<uri> [mix repeat]? auto none inherit	auto		no		aural [p. 305]
'position' [p. 135]	static relative absolute fixed inherit	static		no		visual [p. 110]
'quotes' [p. 207]	[<string> <string>]+ none inherit	depends on user agent		yes		visual [p. 110]
'richness' [p. 319]	<number> inherit	50		yes		aural [p. 305]
'right' [p. 137]	<length> <percentage> auto inherit	auto	positioned elements	no	refer to width of containing block	visual [p. 110]
'speak-header' [p. 321]	once always inherit	once	elements that have table header information	yes		aural [p. 305]
'speak-numeral' [p. 320]	digits continuous inherit	continuous		yes		aural [p. 305]
'speak-punctuation' [p. 319]	code none inherit	none		yes		aural [p. 305]
'speak' [p. 309]	normal none spell-out inherit	normal		yes		aural [p. 305]
'speech-rate' [p. 316]	<number> x-slow slow medium fast x-fast faster slower inherit	medium		yes		aural [p. 305]
'stress' [p. 318]	<number> inherit	50		yes		aural [p. 305]
'table-layout' [p. 282]	auto fixed inherit	auto	'table' and 'inline-table' elements	no		visual [p. 110]
'text-align' [p. 258]	left right center justify inherit	a nameless value that acts as 'left' if 'direction' is 'ltr', 'right' if 'direction' is 'rtl'	block containers	yes		visual [p. 110]
'text-decoration' [p. 259]	none [underline overline line-through blink] inherit	none		no (see prose)		visual [p. 110]
'text-indent' [p. 257]	<length> <percentage> inherit	0	block containers	yes	refer to width of containing block	visual [p. 110]
'text-transform' [p. 263]	capitalize uppercase lowercase none inherit	none		yes		visual [p. 110]
'top' [p. 136]	<length> <percentage> auto inherit	auto	positioned elements	no	refer to height of containing block	visual [p. 110]
'unicode-bidi' [p. 168]	normal embed bidi-override inherit	normal	all elements, but see prose	no		visual [p. 110]
'vertical-align' [p. 192]	baseline sub super top text-top middle bottom text-bottom <percentage> <length> inherit	baseline	inline-level and 'table-cell' elements	no	refer to the 'line-height' of the element itself	visual [p. 110]

Full property table

Name	Values	Initial value	Applies to (Default: all)	Inherited?	Percentages (Default: N/A)	Media groups
'visibility' [p. 201]	visible hidden collapse inherit	visible		yes		visual [p. 110]
'voice-family' [p. 317]	[[<specific-voice> <generic-voice>],]* [<specific-voice> <generic-voice>] inherit	depends on user agent		yes		aural [p. 305]
'volume' [p. 308]	<number> <percentage> silent x-soft soft medium loud x-loud inherit	medium		yes	refer to inherited value	aural [p. 305]
'white-space' [p. 264]	normal pre nowrap pre-wrap pre-line inherit	normal		yes		visual [p. 110]
'widows' [p. 227]	<integer> inherit	2	block container elements	yes		visual [p. 110] , paged [p. 110]
'width' [p. 174]	<length> <percentage> auto inherit	auto	all elements but non-replaced inline elements, table rows, and row groups	no	refer to width of containing block	visual [p. 110]
'word-spacing' [p. 262]	normal <length> inherit	normal		yes		visual [p. 110]
'z-index' [p. 164]	auto <integer> inherit	auto	positioned elements	no		visual [p. 110]

Full property table

Appendix G. Grammar of CSS 2.1

Contents

G.1 Grammar	449
G.2 Lexical scanner	451
G.3 Comparison of tokenization in CSS 2.1 and CSS1	453
G.4 Implementation note	454

This appendix is non-normative.

The grammar below defines the syntax of CSS 2.1. It is in some sense, however, a superset of CSS 2.1 as this specification imposes additional semantic constraints not expressed in this grammar. A conforming UA must also adhere to the forward-compatible parsing rules [p. 49], the selectors notation, the property and value notation [p. 29], and the unit notation. However, not all syntactically correct CSS can take effect, since the document language may impose restrictions that are not in CSS, e.g., HTML imposes restrictions on the possible values of the "class" attribute.

G.1 Grammar

The grammar below is LALR(1) (but note that most UA's should not use it directly, since it does not express the parsing conventions [p. 60], only the CSS 2.1 syntax). The format of the productions is optimized for human consumption and some short-hand notation beyond Yacc (see [YACC]) is used:

- *: 0 or more
- +: 1 or more
- ?: 0 or 1
- |: separates alternatives
- []: grouping

The productions are:

```
stylesheet
: [ CHARSET_SYM STRING ';' ]?
  [S|CDO|CDC]* [ import [ CDO S* | CDC S* ]* ]*
  [ [ ruleset | media | page ] [ CDO S* | CDC S* ]* ]*
;
import
: IMPORT_SYM S*
  [STRING|URI] S* media_list? ';' S*
;
media
: MEDIA_SYM S* media_list LBRACE S* ruleset* '}' S*
;
media_list
```

```

    : medium [ COMMA S* medium]*
    ;
medium
    : IDENT S*
    ;
page
    : PAGE_SYM S* pseudo_page?
      '{' S* declaration? [ ';' S* declaration? ]* '}' S*
    ;
pseudo_page
    : ':' IDENT S*
    ;
operator
    : '/' S* | ',' S*
    ;
combinator
    : '+' S*
    | '>' S*
    ;
unary_operator
    : '-' | '+'
    ;
property
    : IDENT S*
    ;
ruleset
    : selector [ ',' S* selector ]*
      '{' S* declaration? [ ';' S* declaration? ]* '}' S*
    ;
selector
    : simple_selector [ combinator selector | S+ [ combinator? selector ]? ]?
    ;
simple_selector
    : element_name [ HASH | class | attrib | pseudo ]*
    | [ HASH | class | attrib | pseudo ]+
    ;
class
    : '.' IDENT
    ;
element_name
    : IDENT | '*'
    ;
attrib
    : '[' S* IDENT S* [ [ '=' | INCLUDES | DASHMATCH ] S*
      [ IDENT | STRING ] S* ]? ']'
    ;
pseudo
    : ':' [ IDENT | FUNCTION S* [IDENT S*]? ')' ]
    ;
declaration
    : property ':' S* expr prio?
    ;
prio
    : IMPORTANT_SYM S*
    ;
expr
    : term [ operator? term ]*

```

```

;
term
: unary_operator?
  [ NUMBER S* | PERCENTAGE S* | LENGTH S* | EMS S* | EXS S* | ANGLE S* |
    TIME S* | FREQ S* ]
  | STRING S* | IDENT S* | URI S* | hexcolor | function
;
function
: FUNCTION S* expr ')' S*
;
/*
* There is a constraint on the color that it must
* have either 3 or 6 hex-digits (i.e., [0-9a-fA-F])
* after the "#"; e.g., "#000" is OK, but "#abcd" is not.
*/
hexcolor
: HASH S*
;

```

G.2 Lexical scanner

The following is the tokenizer, written in Flex (see [FLEX]) notation. The tokenizer is case-insensitive.

The "\377" represents the highest character number that current versions of Flex can deal with (decimal 255). It should be read as "\4177777" (decimal 1114111), which is the highest possible code point in Unicode/ISO-10646.

```

%option case-insensitive

h          [0-9a-f]
nonascii  [\\200-\\377]
unicode   \\{h}{1,6}(\r\n|[\t\r\n\f])?
escape    {unicode}|\\[^r\n\f0-9a-f]
nmstart   [_a-z]|{nonascii}|{escape}
nmchar    [_a-z0-9-]|{nonascii}|{escape}
string1   \"([^\n\r\f\\\"]|\\{nl}|{escape})*\"
string2   \'([^\n\r\f\\\' ]|\\{nl}|{escape})*\'
badstring1 \"([^\n\r\f\\\"]|\\{nl}|{escape})*\\?
badstring2 \'([^\n\r\f\\\' ]|\\{nl}|{escape})*\\?
badcomment1 \\/*[^\n\r\f\\*+([^\n\r\f\\*+)]*
badcomment2 \\/*[^\n\r\f\\*+([^\n\r\f\\*+)]*
baduri1   url\({w}\)([!#$%&*~\-\[\]~]|{nonascii}|{escape})*{w}
baduri2   url\({w}\){string}{w}
baduri3   url\({w}\){badstring}
comment   \\/*[^\n\r\f\\*+([^\n\r\f\\*+)]*\/
ident     -?{nmstart}{nmchar}*
name      {nmchar}+
num       [0-9]+|[0-9]*\".[0-9]+
string    {string1}|{string2}
badstring {badstring1}|{badstring2}
badcomment {badcomment1}|{badcomment2}
baduri    {baduri1}|{baduri2}|{baduri3}
url       ([!#$%&*~\-\[\]~]|{nonascii}|{escape})*
s         [\t\r\n\f]+
w         {s}?

```

Grammar of CSS 2.1

```

nl          \n|\r\n|\r|\f

A          a|\0{0,4}(41|61)(\r\n|[ \t\r\n\f])?
C          c|\0{0,4}(43|63)(\r\n|[ \t\r\n\f])?
D          d|\0{0,4}(44|64)(\r\n|[ \t\r\n\f])?
E          e|\0{0,4}(45|65)(\r\n|[ \t\r\n\f])?
G          g|\0{0,4}(47|67)(\r\n|[ \t\r\n\f])?|\g
H          h|\0{0,4}(48|68)(\r\n|[ \t\r\n\f])?|\h
I          i|\0{0,4}(49|69)(\r\n|[ \t\r\n\f])?|\i
K          k|\0{0,4}(4b|6b)(\r\n|[ \t\r\n\f])?|\k
L          l|\0{0,4}(4c|6c)(\r\n|[ \t\r\n\f])?|\l
M          m|\0{0,4}(4d|6d)(\r\n|[ \t\r\n\f])?|\m
N          n|\0{0,4}(4e|6e)(\r\n|[ \t\r\n\f])?|\n
O          o|\0{0,4}(4f|6f)(\r\n|[ \t\r\n\f])?|\o
P          p|\0{0,4}(50|70)(\r\n|[ \t\r\n\f])?|\p
R          r|\0{0,4}(52|72)(\r\n|[ \t\r\n\f])?|\r
S          s|\0{0,4}(53|73)(\r\n|[ \t\r\n\f])?|\s
T          t|\0{0,4}(54|74)(\r\n|[ \t\r\n\f])?|\t
U          u|\0{0,4}(55|75)(\r\n|[ \t\r\n\f])?|\u
X          x|\0{0,4}(58|78)(\r\n|[ \t\r\n\f])?|\x
Z          z|\0{0,4}(5a|7a)(\r\n|[ \t\r\n\f])?|\z

%%

{s}                {return S;}

\/\*[\^]*\*+([\^/\*][\^]*\*+)*\/          /* ignore comments */
{badcomment}                /* unclosed comment at EOF */

"<!--"            {return CDO;}
"-->"            {return CDC;}
"~="             {return INCLUDES;}
"|="            {return DASHMATCH;}

{string}          {return STRING;}
{badstring}      {return BAD_STRING);}

{ident}          {return IDENT;}

"#"{name}        {return HASH;}

@{I}{M}{P}{O}{R}{T}    {return IMPORT_SYM;}
@{P}{A}{G}{E}        {return PAGE_SYM;}
@{M}{E}{D}{I}{A}     {return MEDIA_SYM;}
"@charset "        {return CHARSET_SYM;}

"! "("{w} | {comment})*{I}{M}{P}{O}{R}{T}{A}{N}{T} {return IMPORTANT_SYM;}

{num}{E}{M}        {return EMS;}
{num}{E}{X}        {return EXS;}
{num}{P}{X}        {return LENGTH;}
{num}{C}{M}        {return LENGTH;}
{num}{M}{M}        {return LENGTH;}
{num}{I}{N}        {return LENGTH;}
{num}{P}{T}        {return LENGTH;}
{num}{P}{C}        {return LENGTH;}
{num}{D}{E}{G}     {return ANGLE;}

```

```

{num}{R}{A}{D}           {return ANGLE;}
{num}{G}{R}{A}{D}       {return ANGLE;}
{num}{M}{S}              {return TIME;}
{num}{S}                 {return TIME;}
{num}{H}{Z}              {return FREQ;}
{num}{K}{H}{Z}          {return FREQ;}
{num}{ident}             {return DIMENSION;}

{num}%                   {return PERCENTAGE;}
{num}                    {return NUMBER;}

{U}{R}{L}" (" {w} {string} {w} )"  {return URI;}
{U}{R}{L}" (" {w} {url} {w} )"     {return URI;}
{baduri}                     {return BAD_URI;}

{ident}" ("                {return FUNCTION;}

.                             {return *yytext;}

```

G.3 Comparison of tokenization in CSS 2.1 and CSS1

There are some differences in the syntax specified in the CSS1 recommendation ([CSS1]), and the one above. Most of these are due to new tokens in CSS2 that did not exist in CSS1. Others are because the grammar has been rewritten to be more readable. However, there are some incompatible changes, that were felt to be errors in the CSS1 syntax. They are explained below.

- CSS1 style sheets could only be in 1-byte-per-character encodings, such as ASCII and ISO-8859-1. CSS 2.1 has no such limitation. In practice, there was little difficulty in extrapolating the CSS1 tokenizer, and some UAs have accepted 2-byte encodings.
- CSS1 only allowed four hex-digits after the backslash (\) to refer to Unicode characters, CSS2 allows six [p. 55]. Furthermore, CSS2 allows a white space character to delimit the escape sequence. E.g., according to CSS1, the string "\abcdef" has 3 letters (\abcd, e, and f), according to CSS2 it has only one (\abcdef).
- The tab character (ASCII 9) was not allowed in strings. However, since strings in CSS1 were only used for font names and for URLs, the only way this can lead to incompatibility between CSS1 and CSS2 is if a style sheet contains a font family that has a tab in its name.
- Similarly, newlines (escaped with a backslash [p. 70]) were not allowed in strings in CSS1.
- CSS2 parses a number immediately followed by an identifier as a DIMENSION token (i.e., an unknown unit), CSS1 parsed it as a number and an identifier. That means that in CSS1, the declaration 'font: 10pt/1.2serif' was correct, as was 'font: 10pt/12pt serif'; in CSS2, a space is required before "serif". (Some UAs accepted the first example, but not the second.)
- In CSS1, a class name could start with a digit (".55ft"), unless it was a dimension (".55in"). In CSS2, such classes are parsed as unknown dimensions (to

allow for future additions of new units). To make ".55ft" a valid class, CSS2 requires the first digit to be escaped (".\35 5ft")

G.4 Implementation note

The lexical scanner for the CSS core syntax in section 4.1.1 [p. 50] can be implemented as a scanner without back-up. In Lex notation, that requires the addition of the following patterns (which do not change the returned tokens, only the efficiency of the scanner):

```
{ident}/\ \      return IDENT;
#{name}/\ \      return HASH;
@{ident}/\ \     return ATKEYWORD;
#/\ \           return DELIM;
@/\ \           return DELIM;
@/-            return DELIM;
@/--\ \        return DELIM;
-/\ \           return DELIM;
-/-            return DELIM;
\
```

Has been intentionally left blank

Appendix H: Has been intentionally left blank

Has been intentionally left blank

Appendix I. Index

This appendix is informative, not normative.

:active, **89**
:after, **203, 97**
:before, **203, 97**
:first, **224**
:first-child, **88**
:first-letter, **94**
:first-line, **92**
:focus, **89**
:hover, **89**
:lang, **91**
:left, **224**
:link, **89**
:right, **224**
:visited, **89**
=, **82**
~=, **82**
|=, **82**

@charset, 57, 71, 71
"@charset", **71**
@import, **102**, 102, 107
@media, 107, 108
@page, **222**

absolute length, **64**
absolutely positioned element, **152**
active (pseudo-class), **89**
actual value, **100**
after, **203**
'all' media group, **110**
ancestor, **45**
<angle>, 314, 315
 definition of, **307**
anonymous, **129**
anonymous boxes., 101

anonymous inline boxes, **132**
 armenian, **216**
 at-rule, **57**
 at-rules, 56
 atomic inline-level box, **131**
 attr(), **206**
 attribute, **45**
 'audio' media group, **110**
 auditory icon, **306**
 Author, **46**
 authoring tool, **46**
 automatic numbering, **203**
 'azimuth', **314**

'background', **237**
 'background-attachment', **235**
 'background-color', **232**
 'background-image', **233**
 'background-position', **236**
 'background-repeat', **234**
 backslash escapes, **55**
 before, **203**
 bidirectionality (bidi), **166**
 'bitmap' media group, **110**
 block, 57
 block box, **129**
 'block', definition of, **133**
 block-level box, **129**
 block-level element, **129**
 BOM, 71
 border edge, **112**
 'border', **125**
 'border-bottom', **124**
 'border-bottom-color', **121**
 'border-bottom-style', **123**
 'border-bottom-width', **120**
 'border-collapse', **288**
 'border-color', **122**
 'border-left', **124**
 'border-left-color', **121**
 'border-left-style', **123**
 'border-left-width', **120**

- 'border-right', **124**
- 'border-right-color', **121**
- 'border-right-style', **123**
- 'border-right-width', **120**
- 'border-spacing', **288**
- <border-style>, **294**
- <border-style>, definition of, **123**
- 'border-style', **124**
- 'border-top', **124**
- 'border-top-color', **121**
- 'border-top-style', **123**
- 'border-top-width', **120**
- <border-width>
 - definition of, **120**
- 'border-width', **121**
- border
 - of a box, **111**
- <bottom>
 - definition of, **199**
- 'bottom', **137**
- box
 - border, **111**
 - content, **111**
 - content height, **113**
 - content width, **113**
 - margin, **111**
 - overflow, **195**
 - padding, **111**

- canvas, 306, **40**
- 'caption-side', **277**
- cascade, **103**
- case sensitivity, **55**
- character encoding, **71**
 - default, **71**
 - user agent's determination of, **71**
- child, **45**
- child selector, **81**
- circle, **215**
- 'clear', **149**
- 'clip', **198**
- clipping region, **198**

close-quote, **209**, 206
 collapsing margin, **117**
 color, 451
 <color>, 122, 233
 definition of, **68**
 'color', **231**
 combinator, **79**
 comments, 60
 computed value, **100**
 conditional import, **102**
 conformance, **47**, 259
 containing block, **171**, **128**, **128**
 initial, **171**
 content, **45**
 content edge, **112**
 'content', **205**
 content
 of a box, **111**
 rendered, **45**
 'continuous' media group, **110**
 <counter>, 206
 <counter>, definition of, **68**
 counter(), **68**
 'counter-increment', **210**
 'counter-reset', **210**
 counters, **210**
 'cue', **312**
 'cue-after', **311**
 'cue-before', **311**
 cursive, definition of, **246**
 'cursor', **297**

'dashed', **123**, 294
 decimal, **215**
 decimal-leading-zero, **215**
 declaration, **59**
 declaration block, **58**
 default style sheet, **103**
 default
 character encoding, 71
 descendant, **45**
 descendant-selectors, **80**

block container box,
border box,
inline box,
padding box, **112**
disc, **215**
'display', **133**
document language, **44**
document tree, **45**
'dotted', **123**, 294
'double', **123**, 295
drop caps, 94
DTD, 84, 169

element, **44**
 following, **46**
 preceding, **46**
'elevation', **315**
em (unit), **63**
empty, **45**
'empty-cells', **290**
ex (unit), **64**
exact matching, **82**

fantasy, definition of, **246**
fictional tag sequence, **92**, 95, 97
first-child, **88**
first-letter, **94**
first-line, **92**
float rules, **148**
'float', **147**
focus, **302**
focus (pseudo-class), **89**
following element, **46**
'font', **253**
'font-family', **242**
'font-size', **251**
'font-style', **247**
'font-variant', **247**
'font-weight', **248**
formatting context, **138**

formatting structure, **40**
forward-compatible parsing, **49**
<frequency>, 318
 definition of, **307**

generated content, **203**
<generic-voice>, definition of, **317**
georgian, **215**
'grid' media group, **110**
'groove', **123**, 295

'height', **182**
'hidden', 294
'hidden', **123**
horizontal margin, 117
hover (pseudo-class), **89**
hyphen-separated matching, **82**

identifier, **55**
identifier, definition of, **55**
ignore, **45**, 47, 47, **60**, 57, 58, 58, 58, 59, 60, 60, 61, 61, 62, 62, 57, 289
inherit, definition of, **101**
initial caps, 94
initial containing block, **171**
initial value, **99**
'inline', definition of, **134**
inline-block, 117
'inline-block', definition of, **134**
inline-level box, **131**
inline-level element, **131**
inline-table, **271**
inner edge, **112**
'inset', **123**, 295
<integer>, 164
 definition of, **63**
'interactive media group, **110**
internal table element, **271**
intrinsic dimensions, **45**
invert, **302**

iso-10646, 451

LALR(1), 449

lang (pseudo-class), **91**

language (human), 91

language code, 82

<left>

definition of, **199**

'left', **138**

<length>, 237, 258, 263, 262, 183, 189, 192, 193, 174, 180

definition of, **63**

'letter-spacing', **262**

ligatures, 262

line box, **139**

line-box, 148

'line-height', **191**

link (pseudo-class), **89**

list properties, **215**

'list-item', definition of, **134**

'list-style', **219**

'list-style-image', **216**

'list-style-position', **217**

'list-style-type', **215**

lower-greek, **216**

lower-latin, **216**

lower-roman, **215**

mapping elements to table parts, 271

margin edge, **112**

'margin', **116**

'margin-bottom', **115**

'margin-left', **116**

'margin-right', **116**

'margin-top', **115**

<margin-width>

definition of, **115**

margin

horizontal, 117

of a box, **111**

vertical, 117

match, **77**
'max-height', **188**
'max-width', **180**
MAY, **43**
media, **108**
media group, **110**
media-dependent import, **102**
message entity, **48**
'min-height', **188**
'min-width', **180**
monospace, definition of, **246**
multiple declarations, **79**
MUST, **43**
MUST NOT, **43**

newline, 70
no-close-quote, **210**, 206
no-open-quote, **210**, 206
none, 205
'none'
 as border style, **123**, 294
 as display value, **134**
normal, 205
<number>, 308, 316, 318, 307, 319, 319, 307, 307, 66, 191, 192
 definition of, **63**

open-quote, **209**, 206
OPTIONAL, **43**
'orphans', **227**
outer edge, **112**
outline, **300**
'outline', **300**
'outline-color', **301**
'outline-style', **301**
'outline-width', **301**
'outset', **123**, 295
overflow, **195**
'overflow', **195**

padding edge, **112**
 'padding', **119**
 'padding-bottom', **119**
 'padding-left', **119**
 'padding-right', **119**
 'padding-top', **119**
 <padding-width>
 definition of, **118**
 padding
 of a box, **111**
 page area, **222**
 page box, **222**
 page selector, **222**
 'page-break-after', **226**
 'page-break-before', **225**
 'page-break-inside', **226**
 page-context, **222**
 'paged' media group, **110**
 parent, **45**
 'pause', **310**
 'pause-after', **310**
 'pause-before', **310**
 <percentage>, **308, 310, 236, 258, 183, 189, 192, 193, 174, 180**
 definition of, **66**
 'pitch', **317**
 'pitch-range', **318**
 pixel, **65**
 'play-during', **312**
 'position', **135**
 positioned element/box, **136**
 positioning scheme, **135**
 preceding element, **46**
 principal block-level box, **129**
 Property, **46**
 property, **59**
 'property-name', **29**
 pseudo-class
 :first, **224**
 :left, **224**
 :right, **224**
 pseudo-classes, **87**
 :active, **89**

- `:focus`, **89**
- `:hover`, **89**
- `:lang`, **91**
- `:link`, **89**
- `:visited`, **89**
- pseudo-elements, **87**
 - `:after`, **203, 97**
 - `:before`, **203, 97**
 - `:first-letter`, **94**
 - `:first-line`, **92, 93**

- quad width, **63**
- 'quotes', **207**

- RECOMMENDED, **43**
- reference pixel, **65**
- relative positioning, **142**
- relative units, **63**
- rendered content, **45**
- replaced element, **44**
- REQUIRED, **43**
- 'richness', **319**
- 'ridge', **123, 295**
- `<right>`
 - definition of, **199**
- 'right', **137**
- root, **45**
- row groups, **271**
- rule sets, **56**
- run-in element, **132**
- 'run-in', definition of, **134**

- sans-serif, definition of, **245**
- scope, **212**
- screen reader, **306**
- selector, **450, 79, 77, 58**
 - match, **77**
 - subject of, **79**
- separated borders, **288**

serif, definition of, **244**
 SHALL, **43**
 SHALL NOT, **43**
 <shape>
 definition of, **199**
 sheet, **221**
 shorthand property, **32**, 104, 79
 SHOULD, **43**
 SHOULD NOT, **43**
 sibling, **46**
 simple selector, **79**
 'solid', **123**, 295
 source document, **44**
 space-separated matching, **82**
 'speak', **309**
 'speak-header', **321**
 'speak-numeral', **320**
 'speak-punctuation', **319**
 <specific-voice>
 definition of, **317**
 specified value, **99**
 'speech' media group, **110**
 'speech-rate', **316**
 square, **215**
 stack level, **165**
 stacking context, **165**
 statements, 56
 'static' media group, **110**
 'stress', **318**
 string, 57
 <string>, 205, 207, 207
 <string>, definition of, **70**
illegal,
 style sheet, 1 [p. 44] **44**
 system fonts, **254**

table, **271**
 table element, **271**
 internal, **271**
 table-caption, **272**
 table-cell, **272**
 table-column, **272**

- table-column-group, **272**
- table-footer-group, **272**
- table-header-group, **271**
- 'table-layout', **282**
- table-row, **271**
- table-row-group, **271**
- tables, **269**
- 'tactile' media group, **110**
- 'text-align', **258**
- 'text-decoration', **259**
- 'text-indent', **257**
- 'text-transform', **263**
- text/css, **48**
- <time>, **310**
 - definition of, **307**
- tokenizer, **451**
- <top>
 - definition of, **199**
- 'top', **136**
- type selector, **80**

- UA, **46**
- unicode, **451**
- 'unicode-bidi', **168**
- universal selector, **80**
- upper-latin, **216**
- upper-roman, **215**
- <uri>, **311, 313, 313, 313, 233, 205, 298**
 - definition of, **67**
- used value, **100**
- User, **46**
- user agent, **46**
- User agent (UA), **46**
- UTF-8, **71**

- valid style sheet, **44**
- validity, **44**
- value, **59**
- vertical margin, **117**
- 'vertical-align', **192**

viewport, **128**
'visibility', **201**
visited (pseudo-class), **89**
visual formatting model, **127**
'visual' media group, **110**
'voice-family', **317**
volume, **308**
'volume', **308**

'white-space', **264**
'widows', **227**
'width', **174**
'word-spacing', **262**

x-height, **64**

'z-index', **164**
